

Multiple Applications – See below for kit numbers and important notes

NOTE: If your vehicle is equipped with vibration dampers between the turns of the coil, it is necessary that these be removed before installing the air springs. Their function will be replaced by the air spring.

Some mid-size GM vehicles have a solid cup located on the lower spring seat which will not allow the air line to exit the coil. It is necessary to removed this cup before installing the air spring.

NOTE: For Suburbans, Tahoes, Yukons, Trailblazers, Envoy, Bravadas, Avalanches, H2 Hummers, Pathfinders, Chevy SSR and Escalades it will be necessary to trim the rubber isolator at the top of the coil spring to ensure adequate valve stem clearance.

The specific kit numbers that this kit is used for are:

40948, 60744W, 60233, 60755, 60244, 60755W, 60255, 60769, 60269, 60769W, 60286, 60779, 60714, 60786, 60733, 60792, 60733W, 65792, 60744, 60810, 60310

I. Preparing the Vehicle

Before beginning the installation, check the clearance from coil spring to exhaust. It is common in your application for the exhaust to be very close to the coil. If there is not more than 2", you will need to move the pipe for additional clearance.

1. Jack up rear of vehicle or raise on hoist. Support frame with safety stands. Lower axle or raise body of vehicle until suspension is fully extended.
2. Install heat shield kits, if supplied. *Separate instructions are included in heat shield package.*
3. Remove plastic cap from barbed stem on end of cylinder. Exhaust the air from the cylinder by rolling it up toward barbed stem. Replace cap on stem to hold flat shape.
4. If necessary, additional clearance between the coil turns may be obtained by removing the shock absorbers from the lower shock mountings and lowering the suspension an additional one to two inches. **CAUTION:** *Observe tension on brake air line. Do not strain.*

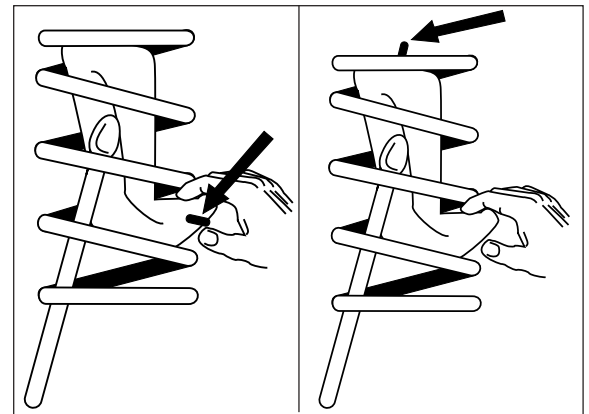

Figure 1a

Figure 1b

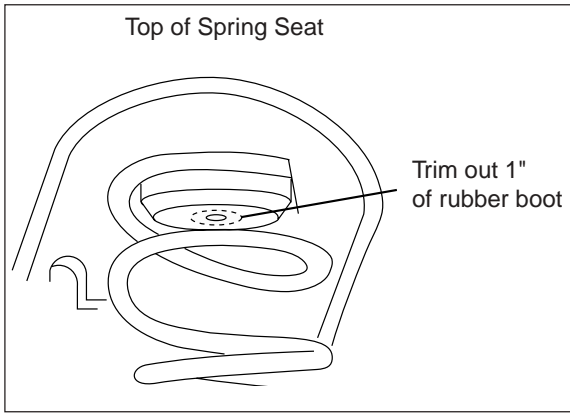

Figure 2

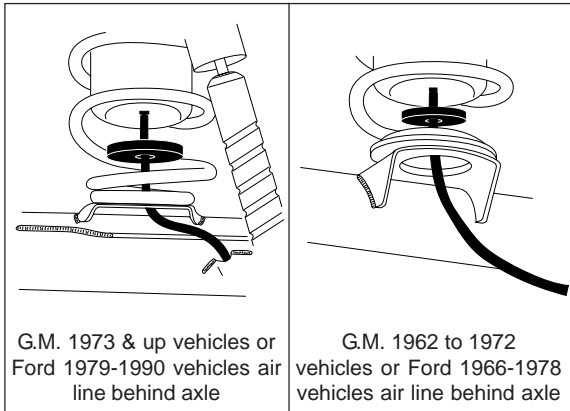

Figure 3a

Figure 3b

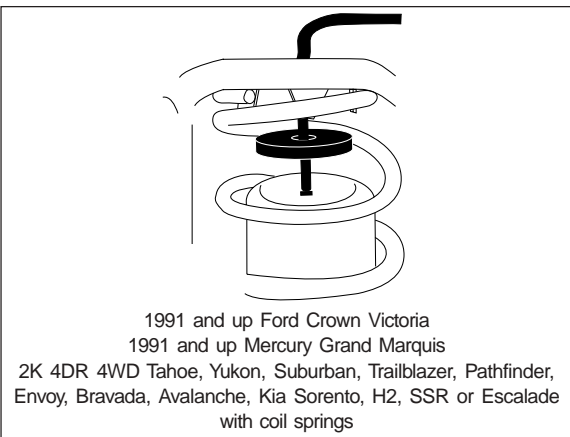

Figure 4

II. Installing the Air Cylinder

IMPORTANT: For Suburbans, Tahoes, Yukons, Trailblazers, Envoy's, Bravadas, Avalanches, H2 Hummers, Chevy SSR and Escalades it will be necessary to trim the rubber isolator at the top for the valve stem clearance (Figure 2).

1. For installing the air cylinder in 1991 and up Crown Victorias, Mercury Grand Marquis, Suburbans, 4DR-4WD Tahoes–Yukons, Trailblazers, Envoy's, Bravadas, Avalanches, Kia Sorentos, H2 Hummers, Pathfinders and Escalades use step 1b.
 - a. Insert flattened air cylinder into coil spring through lowest opening with stem at the *bottom* (Figure 1a).
 - b. Insert flattened air cylinder into coil spring through lowest opening with the stem at the *top* (Figure 1b).
2. Push the cylinder up within the coil by hand or with a blunt instrument such as a spoon-type tire iron.
3. When the cylinder is completely within the coil, remove the cap and allow the cylinder to assume its "as molded" shape.
4. Insert the protector (see vehicle specific application below):
 - a. FOR 1973 and up GM vehicles and 1979–1990 Ford vehicles: Push the cylinder to the top of the coil and insert protector on top of lower spring seat (Figure 3a).
 - b. FOR 1962–1972 GM vehicles and 1966–1978 Ford vehicles: Push the cylinder to the top of the coil and insert protector on top of lower spring seat (Figure 3b).
 - c. 1991 and up Crown Victorias, Mercury Grand Marquis, 2000 Suburbans, 4DR-4WD Tahoes and Yukons, Trailblazers, Envoy's, Bravadas, Avalanches, Kia Sorentos, H2 Hummers, Pathfinders, Chevy SSR and Escalades: Push cylinder to the bottom of the coil and insert protector at the top (Figure 4).

NOTE: The protector can be inserted into the coil facing either direction.

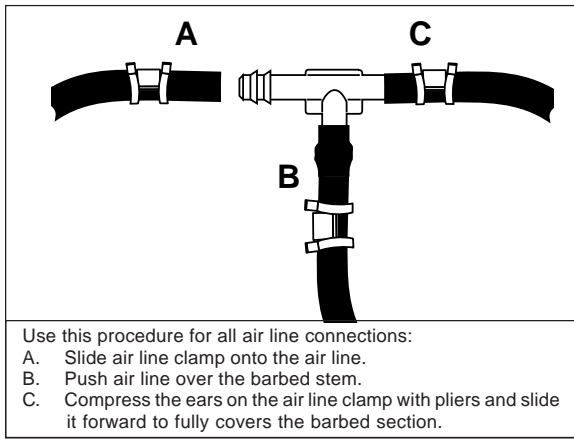

Figure 5

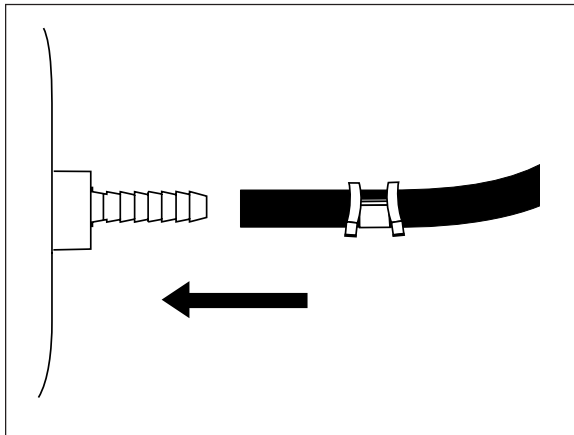

Figure 6

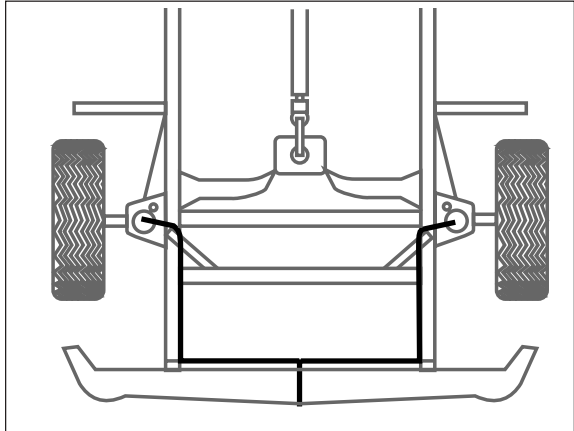

Figure 7

III. Installing the Air Line

Install air line as detailed on pages 2 and 3. A tee air line installation is recommended unless weight in vehicle varies from one side to the other and unequal pressures are needed to level the load (or compensate for axle torque transfer in racing application). Dual air lines are used in this case.

TEE AIR LINE ROUTING

CAUTION: To prevent air line from melting, keep it at least 8" from exhaust system.

1. Locate desired tee location on the frame rail or cross member. Determine and cut adequate length of air line to reach from tee to left and right side on air cylinders.

CAUTION: Leave sufficient air line slack to prevent any strain on fitting during axle motions.

2. Slide air line clamp onto the air line.
3. Push the air line over one side of the tee until all the barbs are covered. With a pair of pliers, slide the air line clamp forward until it fully covers the barbed section. Repeat entire procedure for other leg of tee (Figure 5).
4. Route along cross member and either lower control arm or upper spring seat to air cylinder.
5. Insert air line through spring seat and spacers.
6. Push the air line onto the stem, covering all the barbs (Figure 6). With the pliers, slide the air line clamp upward until it fully covers the barbed section.
7. Push the remaining air line over the last fitting on tee and route along frame to desired inflation valve location (Figure 6). Attach with plastic straps or wire.
8. Select a location for inflation valve in the gas cap well, the trunk, rear bumper, fender flange or behind license plate, insuring that the valve will be protected and accessible with an air hose.
9. Drill $\frac{5}{16}$ " hole for inflation valve and mount as in illustration (Figure 8). Rubber washer is for outside weather seal.
10. Slide air line clamp over the air line. Push air line onto fitting covering all barbs, with pliers slide the air line clamp forward until it fully covers the barbed section (Figure 9).
11. Raise axle or lower body until air cylinders lightly touch upper spring seat and lower spacers.

- Check tail pipe clearance and insure that it is at least 2-3 inches from air cylinder. If necessary, loosen clamps and rotate or move to obtain additional clearance. If heat shield is provided, install. Attach shock absorbers if removed earlier in the installation.

CAUTION: Do not inflate air cylinders before reading the maintenance and operation section.

- Continue on with Section IV, Completing the Installation.

DUAL AIR LINE ROUTING

CAUTION: To prevent air line from melting, keep it at least 8" from exhaust system.

- Select a location for the inflation valves in the rocker panel flange, or rear bumper, assuring that each valve will be protected and accessible with an air hose (Figure 9).
- Determine and cut adequate length of air line to reach from valve location to left side air cylinder.

CAUTION: Leave sufficient air line slack to prevent any strain on fitting during axle motions.

- Insert the air line through the spring seat and spacer.
- Slide air clamp onto the cut air line.
- Push the air line onto the stem, covering all the barbed section (Figure 6). With pliers slide the air line clamp forward until it fully covers barbed section.
- Repeat process for right side.
- Drill $\frac{5}{16}$ " hole for inflating valves and mount as illustrated. Rubber washer is for outside weather seal (Figure 8).
- Route air line along control arm and frame to inflation valve location and cut off excess.
- Slide a clamp onto the air line and push the air line over the fitting, covering all the barbs. With pliers slide the air line clamp forward until it fully covers the barbed section (Figure 9).
- Raise axle or lower body until air cylinders lightly touch upper spring seat and lower spacers.

- Check tail pipe clearance and insure that it is at least 2-3 inches from air cylinders. If necessary, loosen clamps and rotate or move to obtain additional clearance. If heat shields are supplied, install them. Attach shock absorbers if removed earlier in the installation.

CAUTION: Do not inflate air cylinders before reading the maintenance and operation section.

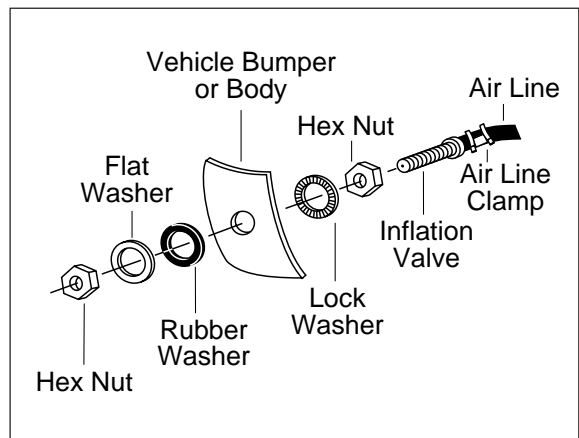

Figure 8

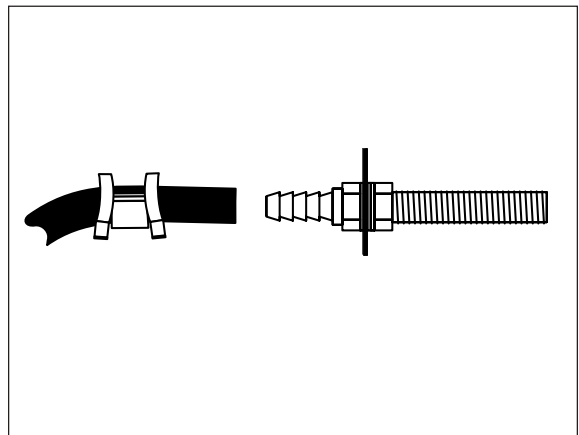

Figure 9

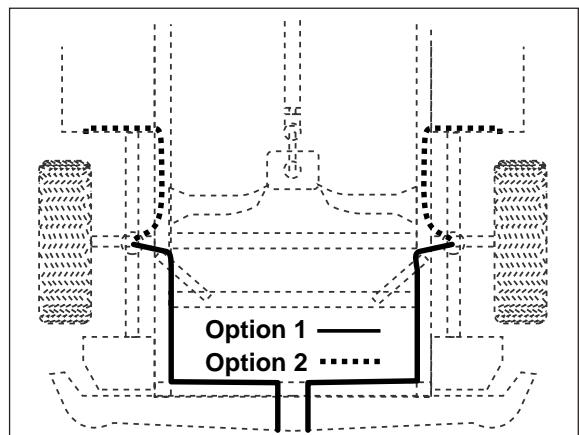

Figure 10

IV. Completing the Installation

Prior to following these steps, review the Maintenance and Operations section below.

1. Inflate cylinders to 35 lbs air pressure. Test for air leaks by applying a liquid solution of $\frac{1}{5}$ dish soap to $\frac{4}{5}$ water to all valve cores, fittings and connections.
 2. Lower vehicle to the ground. Read Maintenance/Operation Tips for proper care of your air cylinders.
 3. Recheck air pressure after 24 hours. A 2-4 p.s.i. loss after initial installation is normal. If pressure has dropped more than 5 lbs. retest for leaks with a soapy/water solution.
12. Continue on with Section IV, Completing the Installation.

Maintenance and Operations

MINIMUM AIR PRESSURE	MAXIMUM AIR PRESSURE
5 psi	35 psi

By following these steps, vehicle owners should obtain the longest life and best results from their air springs.

Maintenance Tips:

1. Check the air pressure in the air springs weekly.
2. Always maintain at least the 5 p.s.i. air pressure to prevent chafing or coil pinch.
3. If you develop a leak in the system, use a soapy/water solution to check all air line connections and the valve core before removing the cylinder.

Operating Tips:

1. Inflate your air springs to 35 p.s.i. before adding the payload. This will allow the air cylinder to properly mesh with the coil spring. After vehicle is loaded, adjust your air pressure (down) to level the vehicle and for ride comfort.
2. When you are carrying a payload it will be helpful to increase the tire inflation pressure in proportion to any overload condition. We recommend a 2 p.s.i. increase above normal (not to exceed tire manufacturers maximum) for each 100 lbs. additional load on the axle.

CAUTION: *Do not exceed the vehicle manufacturers maximum gross vehicle weight rating.*

CAUTION: *Failure to maintain minimum pressure will void the warranty.*

Thank you for purchasing Air Lift Products



Mailing Address:
AIR LIFT COMPANY
P.O. Box 80167
Lansing, MI 48908-0167

Street Address:
AIR LIFT COMPANY
2727 Snow Rd.
Lansing, MI 48917

Local Phone: (517) 322-2144
Fax: (517) 322-0240

For Technical Assistance call 1-800-248-0892

“The Choice of the Professional Installer”

Printed in the USA