











# Installation Instructions Mirror Mounting Brackets

## Vehicle Application:

- Jeep \ CJ-7 with 2-Piece Bestop Doors and 51261 Mirrors  
1976 – 2006  
Part Number: 51258

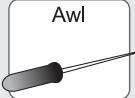
[www.Bestop.com](http://www.Bestop.com) - We're here to help! Visit our web site and click on "[Ask a Question](#)". Click here for more [Jeep® Accessories by Bestop](#).

INSTALLATION TIME	SKILL LEVEL
 1 Hour	    1 - Easy

TOOLS			
 Awl	 Utility Knife	 Phillips Screwdriver #2	 Safety Glasses



**⚠ WARNING** This product is designed primarily to enhance the appearance of the vehicle. Do not rely in any way on the components of this product to protect against injury or death in the event of an accident. Never operate the vehicle in excess of manufacturer's specifications.

### WEAR SEAT BELTS AT ALL TIMES

Read and follow, precisely, all installation instructions provided when installing product. Failure to do so may result in a poor fit and could place occupants of the vehicle in a potentially dangerous situation.

# Mirror Mounting Bracket Installation Instructions

## Parts List and Hardware Identification

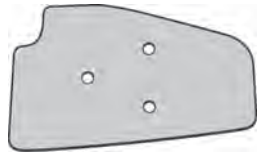

□ Outer Mounting Plate, Part Number 443.75, Qty - 2



□ Left Inner Mounting Plate, Part Number 443.77, Qty - 1



□ Right Inner Mounting Plate, Part Number 443.76, Qty - 1

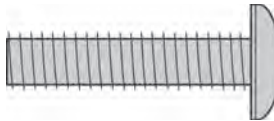

□ 1/4-20 x 1-1/4 Phillips Pan Head Screw, Part Number 397.22, Qty - 6

## 2 Punch Holes

Push the bracket up as high as it will go. Locate the tapped holes in the bracket with an awl and poke a hole in the fabric at each hole location. Cut away the fabric around each hole.

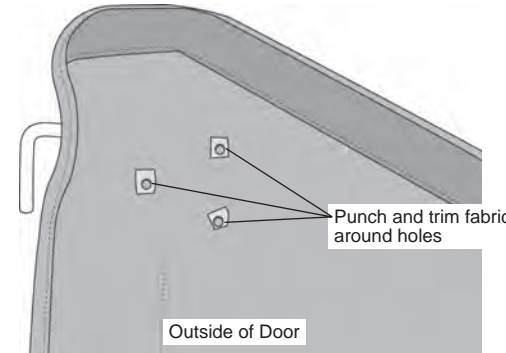

## 1 Install Inner Mounting Plate

Slide the Left Inner Mounting Plate under the fabric flap on the inside of the left door. Hook the rear of the bracket over the diagonal rod of the door frame. Push the front of the bracket into the hole in the fabric next to the top pivot pin so it overlaps the frame.

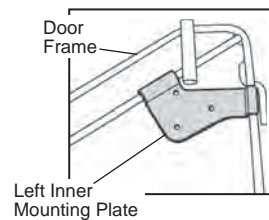
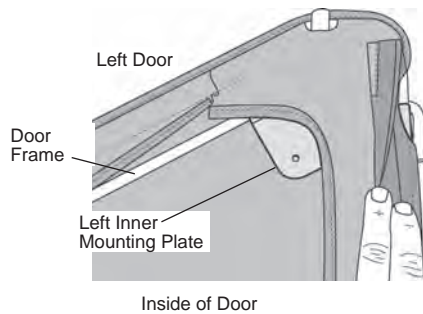

## 3 Install Outer Mounting Plate and Mirror

Lay an Outer Mounting Plate on the outside of the door and align the holes with the holes in the Inner Mounting Plate. Hold the left mirror over the outer plate and mount it to the inner plate with three (3) 1/4-20 x 1-1/4" Phillips Pan Head Screws. Alternate tightening each screw until the mirror is secure.

Repeat Steps 1 - 3 on the right door.

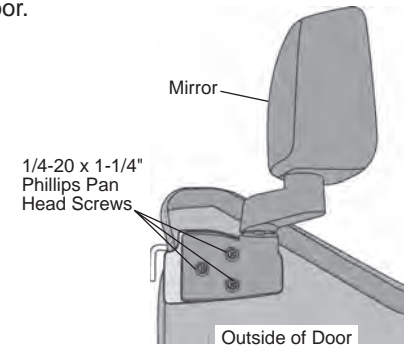
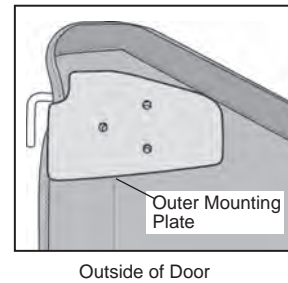

# Mirror Mounting Bracket Installation Instructions

---

## LIMITED WARRANTY

We warrant our product to be free from defects in material and workmanship, for the terms specified below, provided there has been normal use and proper maintenance. This warranty applies to the original purchaser only. All remedies under this warranty are limited to the repair or replacement of any item or items found by the factory to be defective within the time period specified. If you have a warranty claim, first you must call our factory at the number below for instructions. You must retain proof of purchase and submit a copy with any items returned for warranty work. Upon completion of warranty work, if any, we will return the repaired or replaced item or items to you freight prepaid. Damage to our products caused by accidents, fire, vandalism, negligence, misinstallation, misuse, Acts of God, or by defective parts not manufactured by us, is not covered under this warranty.

THE WARRANTY TIME PERIOD IS AS FOLLOWS FOR REPLACE-A-TOP™, SAILCLOTH REPLACE-A-TOP™, SUPERTOP®, SUPERTOP® REPLACEMENT SKINS, SUNRIDER®, AND TIGERTOP®: TWO YEARS FROM DATE OF PURCHASE.

THE WARRANTY TIME PERIOD IS AS FOLLOWS FOR ALL OTHER "SOFT GOODS" MANUFACTURED BY OUR COMPANY (USING PRIMARILY VINYL, PLASTICS, AND/OR FOAM): ONE YEAR FROM DATE OF PURCHASE.

THE WARRANTY TIME PERIOD IS AS FOLLOWS FOR ALL OTHER "HARD GOODS" MANUFACTURED BY OUR COMPANY (USING PRIMARILY METALS, PLASTICS, AND/OR FIBERGLASS): ONE YEAR FROM DATE OF PURCHASE.

ANY IMPLIED WARRANTIES OF MERCHANTABILITY AND/OR FITNESS FOR A PARTICULAR PURPOSE CREATED HEREBY ARE LIMITED IN DURATION TO THE SAME DURATION AND SCOPE AS THE EXPRESS WRITTEN WARRANTY. OUR COMPANY SHALL NOT BE LIABLE FOR ANY INCIDENTAL OR CONSEQUENTIAL DAMAGE.

Some states do not allow limitations on how long an implied warranty lasts, or the exclusion or limitation of incidental or consequential damages, so the above limitations or exclusions may not apply to you. This warranty gives you specific legal rights, and you may also have other rights which vary from state to state.

