















Installation Instructions Specialty Tigertop™

Vehicle Application

- Jeepster Commando
1967 – 1973
Part Number: 51311

www.Bestop.com - We're here to help! Visit our web site and click on ["Ask a Question"](#). Click here for more [Jeep Accessories by Bestop](#).

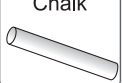
INSTALLATION TIME	SKILL LEVEL
 <p>3 Hours</p>	 <p>3 - Moderately Difficult</p>

TOOLS			
 Power Drill 3/32", 5/32" and 3/8" Bits	 Center Punch	 Tape Measure 10'	 Adjustable Wrench
 Phillips Screwdriver	 Flat-Head Screwdriver Large and Small	 Hammer	 Pencil
 Chalk	 Safety Glasses		

	CAUTION Safety glasses should be worn at all times while installing this product.
---	--

<p>Installation Tips</p> <p>Before you begin installing this assembly, read all instructions thoroughly.</p> <p>For a smooth fit:</p> <p>For ease in installation, the product should be installed at temperatures above 72° F. Below this temperature, the fabric may contract an inch or more, making it difficult to fit to the vehicle. It is normal for fabric to contract and wrinkle when stored in the shipping carton. Within a few days after the installation, the fabric will relax and the wrinkles will disappear.</p>
--





<p>! WARNING This product is designed primarily to enhance the appearance of the vehicle and to shield the occupants from ordinary weather conditions. Do not rely in any way on the components of this product to contain occupants within the vehicle, or to protect against injury or death in the event of an accident. This product will not protect the occupants from falling objects. Never operate the vehicle in excess of manufacturer's specifications.</p> <p>WEAR SEAT BELTS AT ALL TIMES</p> <p>Read and follow, precisely, all installation instructions provided when installing product. Failure to do so may result in a poor fit and could place occupants of the vehicle in a potentially dangerous situation.</p>

Specialty Tigertop™ – Installation Instructions

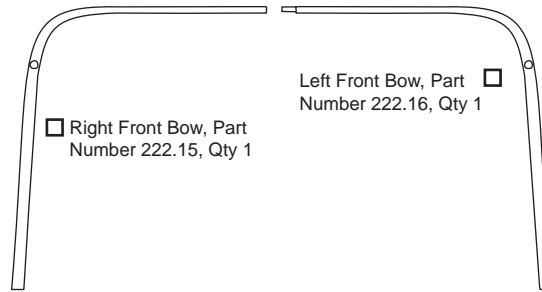
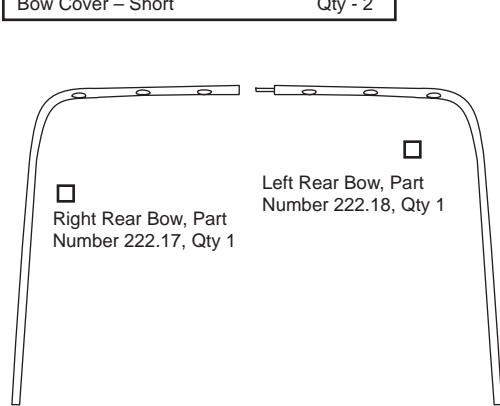
Top Fabric	Qty - 1
Bow Covers – Long	Qty - 2
Bow Cover – Short	Qty - 2





Parts List and Hardware Identification

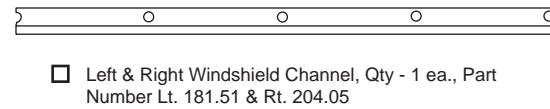
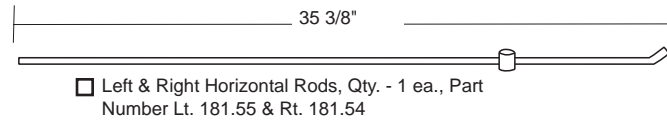
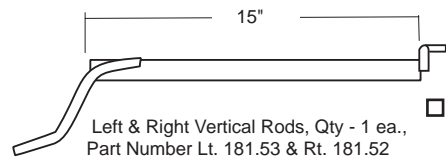

 #6 S/M Screw, Qty - 31, Part Number 9.69	 Body Stud, Qty - 31, Part Number 9.68
 #10 Oval Head Screw, Part Number 155.49, Qty - 4	 Footman Loop, Qty - 2, Part Number 272.29

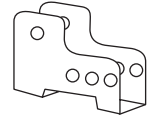

Bow Mounting Kit, Packaged together, Part Number 182.76

			
Bow Mounting Bracket, Qty 2	#10 S/M Screw, Qty 4	Clevis Pin, Qty 4	Hairpin Clevis Keeper, Qty 4

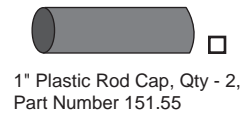

Specialty Tigertop™ – Installation Instructions

CAUTION When drilling in the top edge of the vehicle body, check underneath for wiring for the rear lights. Pull the wiring out of the way before drilling.

IMPORTANT: The Bracket secures to the vehicle by using two Sheet Metal Screws. Use the two holes in each bracket which are closest to the outer edge of the body.

1 Install Bow Mounting Brackets

Locate one of the Bow Mounting Brackets and the (4) #10 Sheet Metal Screws in the Bow Mounting Kit and place them in easy reach. Measure a distance of 36 inches along the body edge from the outside rear of the Jeep® body. Make a pencil mark on each side of the Jeep® body at the 36 inch mark. This will be the location for the FRONT HOLE of the Bow Mounting Bracket.

Center punch your marks and drill 5/32" holes at these locations. Tighten the bracket in place using 2 #10 Sheet Metal Screws.

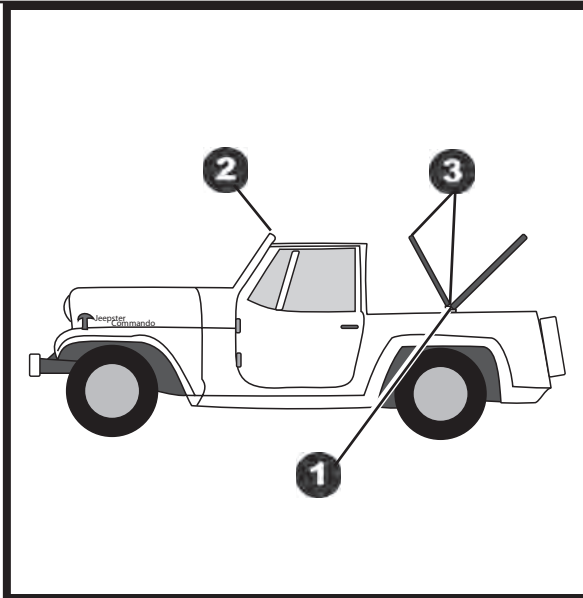
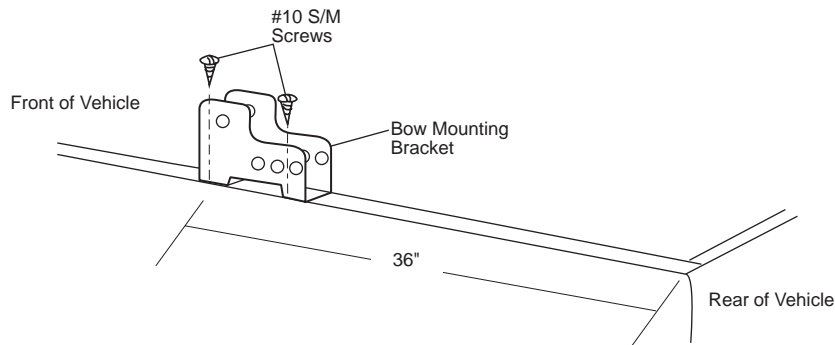

2 Install Windshield Channel

Center the Windshield Channels on the TOP of the Jeep® windshield frame so that the holes in the two Channels line up with the holes in the frame. The Channel opening should face to the front of the vehicle. Mount the Channels using the bolts that came with your factory hard top.

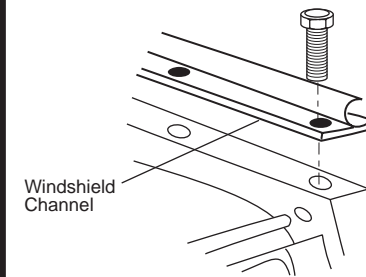

3 Install Front Bow

Connect the two halves of the Front Bow Assembly and slide a short Bow Cover over each leg of the Bow. THE TWO LARGE HOLES IN THE FRONT BOW ASSEMBLY SHOULD FACE THE FRONT OF THE VEHICLE.

Mount one leg of the Front Bow Assembly into the front of the Bow Mounting Bracket, using the Clevis Pin and Hairpin Keeper. Repeat this process for the other leg of the Front Bow Assembly.

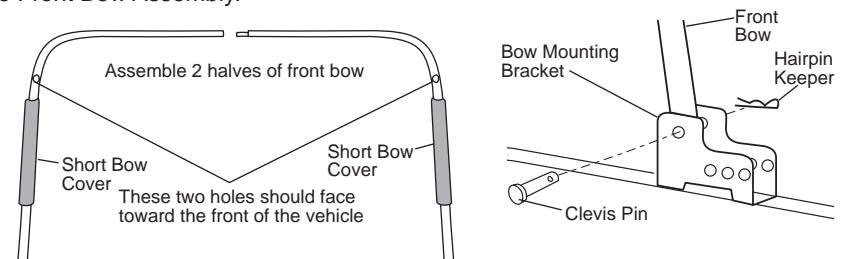

Specialty Tigertop™ – Installation Instructions

4 Install Body Studs on Rear Bow

Connect the two halves of the Rear Bow Assembly and slide a long Bow Cover over each leg. Then install a Body Stud in each hole in the Rear Bow Assembly, using a #6 Sheet Metal Screw.

Assemble 2 halves of the rear bow and attach studs

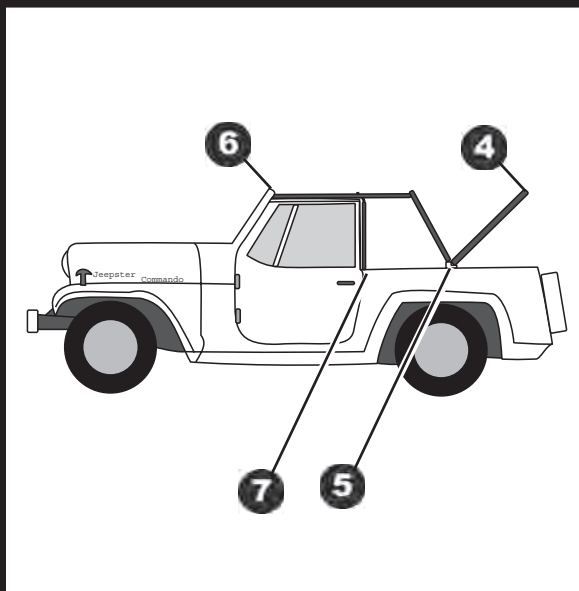
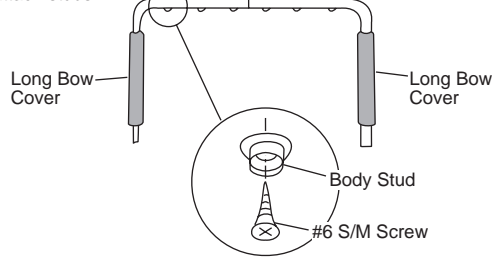

7 Vertical Rod Location

To locate the Vertical Rods, measure 1/2 inch in from the edge of the body and 1/2 inch back from the door opening. Mark the location, center punch and drill a 3/8 inch hole.

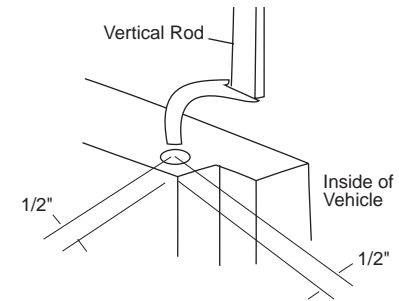

5 Install Rear Bow

Mount one leg of the Rear Bow Assembly into the CENTER HOLE at the back of the Bow Mounting Bracket, using a Clevis Pin and Hairpin Keeper. Repeat this process for the other leg of the Rear Bow Assembly.

NOTE Attach the Rear Bow to the center hole in the bracket. The other two holes adjust the tightness of the top after installation.

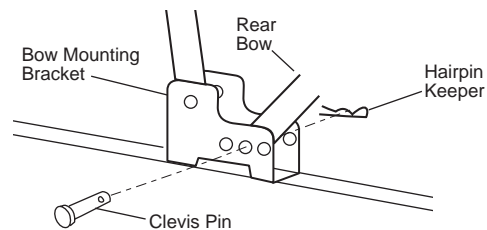

6 Horizontal Rod Location

To locate the Horizontal Rod, measure 1 inch above the top edge of the door windows in the corner of the windshield frame. Mark the location, center punch and drill a 3/8 inch hole.

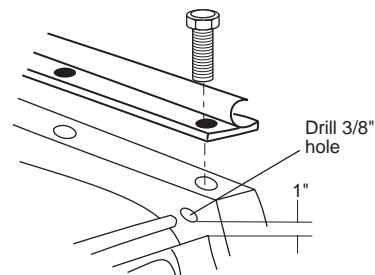

Specialty Tigertop™ – Installation Instructions

8 Install Top on Vehicle

Unfold the Top and drape it over the Front Bow. Insert the Top into the Windshield Channel groove at one side and slide it in. Slide the Top all the way through the Channel groove so that the other seam is outside the channel. Then work that side back into the groove and center the Top.

Lift the Rear Bow and drape the Top over it. Snap the flaps on the inside of the Top to the Body Studs of the Rear Bow.

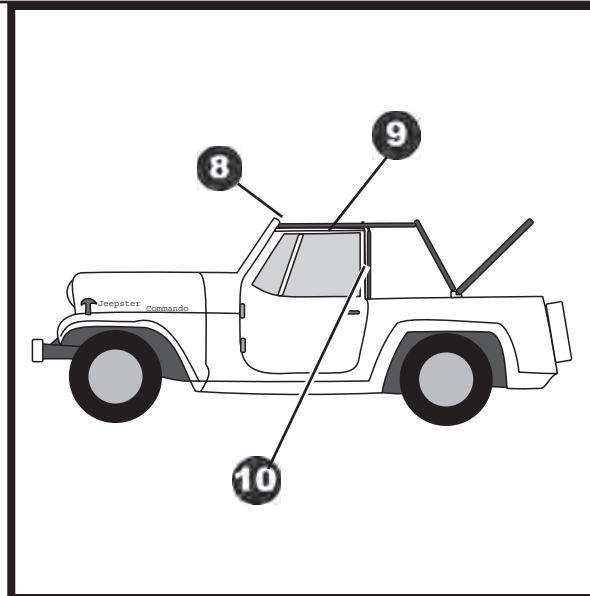
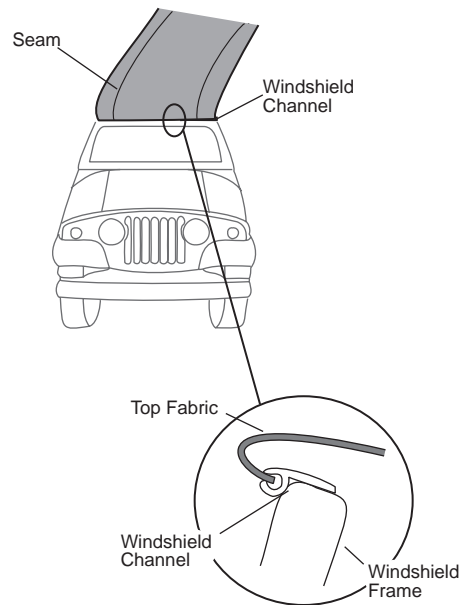

10 Install Vertical Rods

Insert one end of the Vertical Rod into the hole you drilled in the body, and the other end through the loop in the Horizontal Rod. Pull the fabric flap around the Vertical Rod and fasten the snaps. Repeat on the other side of the vehicle.

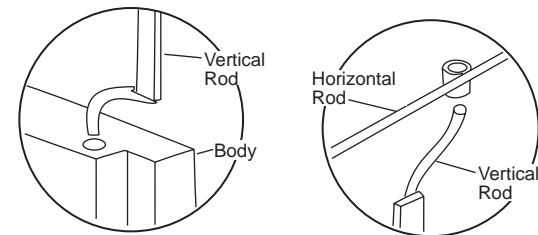

9 Install Horizontal Rods

Attach a 1" Plastic Rod Cap to the bent end of each Horizontal Rod and slide the rod through the fabric sleeve above the door. Insert the straight end of the rod into the hole in the windshield frame. Insert the bent end into the hole in the Front Bow with the loop to the inside of the vehicle. Repeat this on the other side of the vehicle.

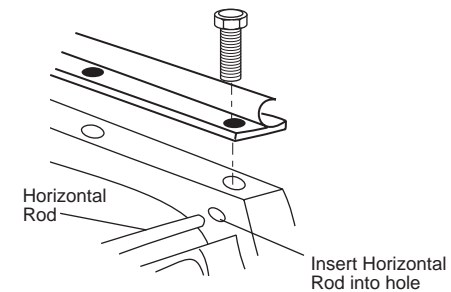

Specialty Tigertop™ – Installation Instructions



WARNING

The following steps are crucial to the proper installation of your Top.

You will need to have a friend help you to insure even tightness and fit of the Top. Make sure the Top is as warm as possible before beginning.

11 Install Rear Corner Studs

Close the zippers on the rear curtain.

Mark the locations for the 2 rear snaps on each side panel. Do this by rubbing chalk on the snaps at the inside of the Top. Place 1 stud on the side corner of the vehicle and 1 stud on the back of the vehicle. Pull down and to the rear, making sure that the side panel comes around the corner.

TO INSURE A GOOD FIT, HAVE YOUR FRIEND PULL DOWN ON THE REAR BOW WHILE YOU PULL THE FABRIC DOWN AND TO THE REAR TO LOCATE THE TWO REAR CORNER STUDS. IF PULLING THE FABRIC INTO POSITION IS EXTREMELY DIFFICULT, TIGHTNESS CAN BE ADJUSTED BY MOVING THE REAR BOW INTO THE FRONT HOLE IN THE BOW MOUNTING BRACKET.

When you are satisfied with the tightness of the Top, press the snaps against the vehicle. The chalk will leave marks for Body Stud positions. Center punch the marks and drill 3/32 inch holes in the body, at the marked locations. Install a Body Stud in each hole with #6 Sheet Metal screws. Now snap the Top down at the corners.

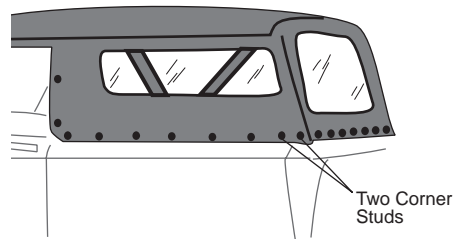
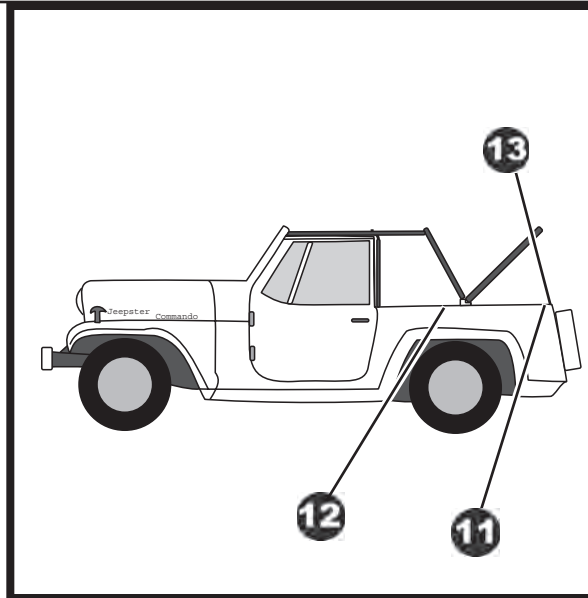

12 Install Studs on Side Panels

Now move to the front of the side panels. Pull the Top Fabric down and forward to eliminate wrinkles and to insure a proper fit. Install Body Studs next to the door openings here and on the opposite side. Snap the top to each new stud.

Install the remaining studs in the side panels. Alternate from side to side as you install the studs and snap the Top down. This will keep the tension evenly spread.

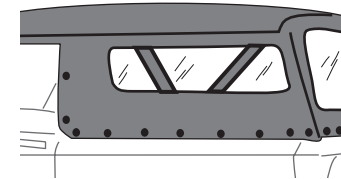

Alternate from side to side installing studs and snapping top

13 Install Rear Curtain Studs

On the rear curtain, mark the locations of the snaps, starting with the outside corners by pulling down and to the outside to eliminate wrinkles. Punch and drill 3/32 inch holes at these locations and install Body Studs with #6 Sheet Metal Screws. Snap the rear curtain down.

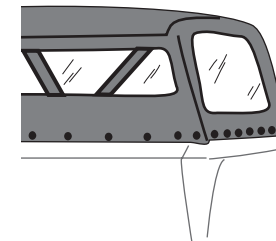

Mark and drill holes for rear curtain studs, starting at the corners

Specialty Tigertop™ – Installation Instructions

14 Install Front Corner Studs

Locate the snap tab on the front corner of your top. Pulling the fabric forward and down, to eliminate wrinkles, mark the location for the Body Studs. Drill 3/32 inch holes and install the Body Studs with #6 Sheet Metal Screws.

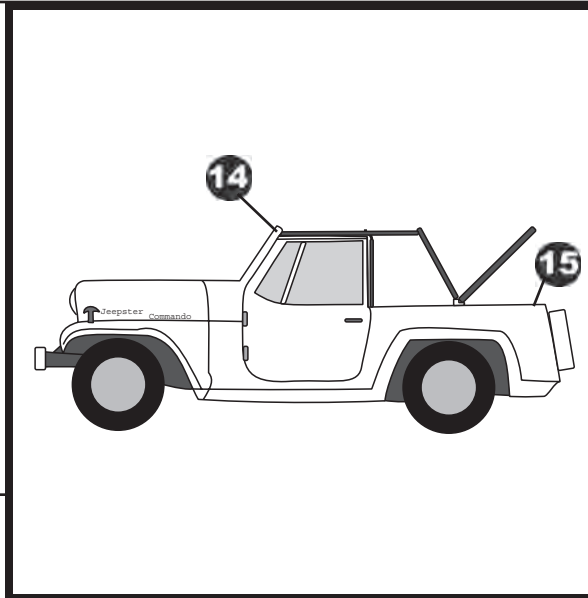
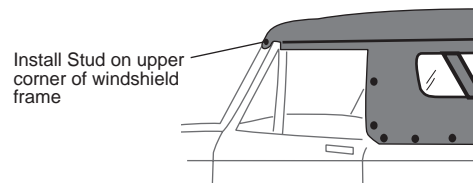

16 Rolling Rear Curtain

To roll the rear curtain, start at the bottom and roll to the inside, avoiding wrinkles in the fabric and windows. Secure with Curtain Strap.

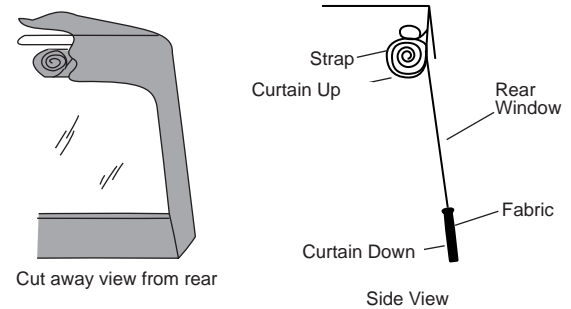

15 Install Footman Loops

Install the two Footman Loops on the inside rear of the vehicle near the corners, but NOT on the tailgate. Drill 5/32 inch holes and secure the Footman Loops in place with #10 Oval Head Screws.

Thread the long strap attached to the Top through the loops and then the buckle. This strap will hold down the Rear Bow when the rear curtain and side panels are rolled. DO NOT OVERTIGHTEN.

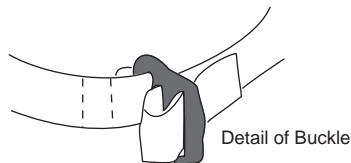
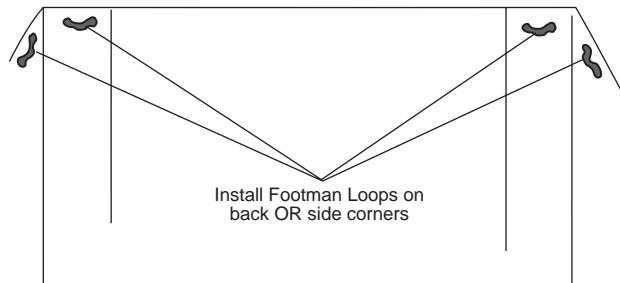

17 Rolling Side Panels

To roll the side curtains, you must first remove the Vertical Rods. Then use the same procedure as for the rear curtain, except you must first make a vertical fold at the rear corner to bring the triangular piece of fabric to the inside.

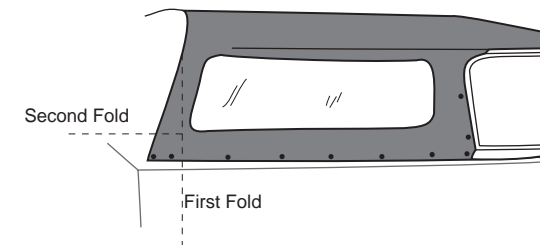

Specialty Tigertop™ – Installation Instructions

18 Folding the Top Down

Unsnap the rear and side curtains and unzip the rear curtain zippers. Then remove both the Vertical and Horizontal Rods. Push the Front Bow toward the Rear Bow.

Fold the side curtain up over the Top, folding along the seam. Then fold the rear curtain up over the side curtains (see figure 14).

Unfasten the Top from the windshield and lower the Top onto the vehicle as you push both Bows down and to the rear (see figures 15 and 16). Smooth out wrinkles and fold the Top in half from front to rear. You may then roll the Top to the back if you wish to keep it in the vehicle, or you may remove the Bows from their mounting bracket by removing the clevis pins and hairpin keepers.

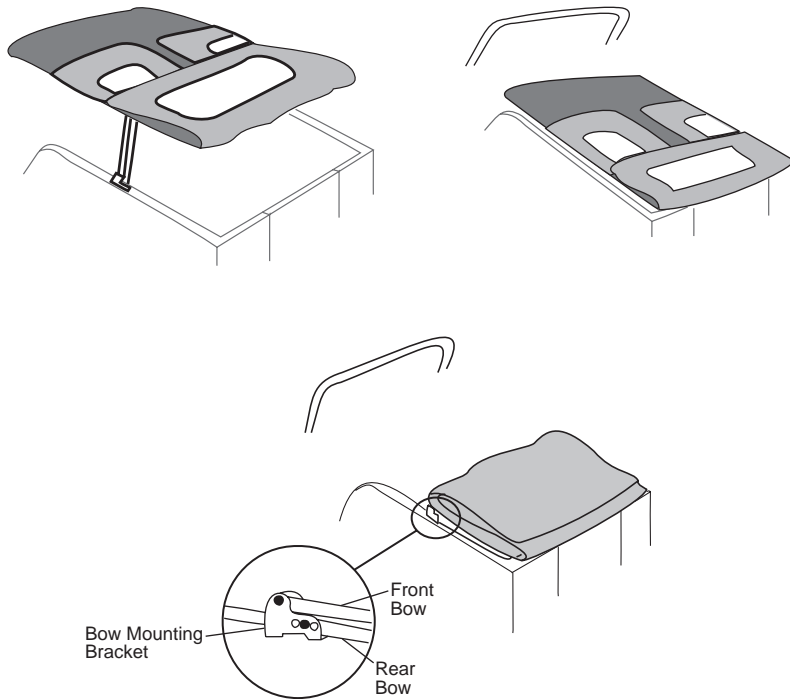

19 Storing the Top

Place sheets of paper over each window before storing. This will protect against scratches. Store the Top by folding and removing from vehicle. Keep the Top stored in its original shipping container in a cool, dry place.

If the Top is to be kept on the vehicle, roll carefully toward the rear and store in a Top Boot, or fasten securely with a nylon rope or straps. Leave attached to the Rear Bow. If you do not want the Rear Bow laying on the spare tire, you may remove the Clevis Pin and Keeper from Rear Bow and slide the Bow under the Front Bow in the Bow Mounting Bracket. Re-secure the Bow to the Bow Mounting Bracket with the Clevis Pin and Keeper.

Specialty Tigertop™ – Installation Instructions

Care and Maintenance of your Bestop Product

Your Bestop product is made of the finest materials available. To keep it looking new and for the maximum possible wear, it will need periodic cleaning and maintenance.

Washing: The fabric should be washed often using soap, warm water and a soft bristle brush. Rinse with clear water to remove all traces of soap or use Bestop-recommended Bestop Cleaner and Bestop Protectant. Bestop Cleaner and Bestop Protectant are specially formulated to provide a total cleaning and protection system. Bestop Cleaner will not harm vehicle finish, is biodegradable and environmentally friendly. Bestop Protectant protects against UV-fading, cracking and hardening.

Windows: Keep windows clean to avoid scratching. DO NOT use a brush on the windows! Wash with a water-soaked cloth or sponge and a mild dishwashing detergent or use Bestop-recommended Bestop Vinyl Window Cleaner, which safely cleans and protects vinyl windows while helping prevent UV damage. NEVER WIPE THE WINDOWS WHEN THEY ARE DRY. Be careful when cleaning snow or frost from the vinyl windows since they are easily scratched and may crack at low temperatures. DO NOT roll the sides or rear window in cold weather. The windows become stiff and will crack.

Zippers: Keeping the zipper cleaned and lubricated with a silicone lubricant will help prevent damage and keep the zippers in a smooth working condition. If a zipper opens behind the slider, the slider may have been spread apart. This problem can usually be repaired by using an ordinary pair of pliers to bring the sides back into parallel. Return slider to the end of the zipper in the normal Open position. Squeeze lightly at first and test the zipper. If the zipper continues to remain open squeeze more firmly with the pliers and try the zipper again. Repeat this procedure until the zipper operates correctly.

Water: Seeping through at the seams may be stopped by applying 3-M Scotchgard® on the inside of the seams. Rips in the fabric may be repaired with Bondex® iron on patches. Iron the patches to the Inside of the top, carefully following the Bondex® instructions.

Snaps: Keep snaps cleaned and lubricated with silicone to help prevent snaps from sticking to the studs. If a snap does become stuck to a stud, use a screwdriver and GENTLY pry apart to prevent permanent damage to the snap or the top fabric.

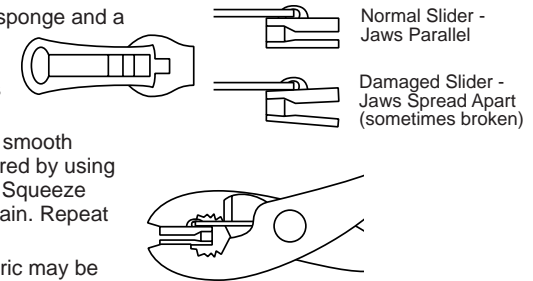

LIMITED WARRANTY

We warrant our product to be free from defects in material and workmanship, for the terms specified below, provided there has been normal use and proper maintenance. This warranty applies to the original purchaser only. All remedies under this warranty are limited to the repair or replacement of any item or items found by the factory to be defective within the time period specified. If you have a warranty claim, first you must call our factory at the number below for instructions. You must retain proof of purchase and submit a copy with any items returned for warranty work. Upon completion of warranty work, if any, we will return the repaired or replaced item or items to you freight prepaid. Damage to our products caused by accidents, fire, vandalism, negligence, misinstallation, misuse, Acts of God, or by defective parts not manufactured by us, is not covered under this warranty.

THE WARRANTY TIME PERIOD IS AS FOLLOWS FOR REPLACE-A-TOP™, SAILCLOTH REPLACE-A-TOP™, SUPERTOP®, SUPERTOP® REPLACEMENT SKINS, SUNRIDER®, AND TIGERTOP®: TWO YEARS FROM DATE OF PURCHASE.

THE WARRANTY TIME PERIOD IS AS FOLLOWS FOR ALL OTHER "SOFT GOODS" MANUFACTURED BY OUR COMPANY (USING PRIMARILY VINYL, PLASTICS, AND/OR FOAM): ONE YEAR FROM DATE OF PURCHASE.

THE WARRANTY TIME PERIOD IS AS FOLLOWS FOR ALL OTHER "HARD GOODS" MANUFACTURED BY OUR COMPANY (USING PRIMARILY METALS, PLASTICS, AND/OR FIBERGLASS): ONE YEAR FROM DATE OF PURCHASE.

ANY IMPLIED WARRANTIES OF MERCHANTABILITY AND/OR FITNESS FOR A PARTICULAR PURPOSE CREATED HEREBY ARE LIMITED IN DURATION TO THE SAME DURATION AND SCOPE AS THE EXPRESS WRITTEN WARRANTY. OUR COMPANY SHALL NOT BE LIABLE FOR ANY INCIDENTAL OR CONSEQUENTIAL DAMAGE.

Some states do not allow limitations on how long an implied warranty lasts, or the exclusion or limitation of incidental or consequential damages, so the above limitations or exclusions may not apply to you. This warranty gives you specific legal rights, and you may also have other rights which vary from state to state.



For further information or request for warranty work, please contact:

Bestop Inc., Customer Service
Toll-Free: (800)845-3567
Main: (303)465-1755
E-mail: csbestop@Bestop.com
Website: www.Bestop.com