



Installation Instructions





Door Jackets



Vehicle Application

- All Jeep CJ, Wrangler and Wrangler Unlimited Models
JK 2007-2009 and all earlier models
Part Number: 51666

www.Bestop.com - We're here to help! Visit our web site and click on "[Ask a Question](#)". Click here for more [Jeep Accessories by Bestop](#).

INSTALLATION TIME	SKILL LEVEL	
 1/4 Hours	 1 - Easy	
TOOLS		
 Adjustable Wrench	 Torx Wrench T40	 Safety Glasses



Door Jackets – Installation Instructions

Parts List

Door Jacket

Qty - 2

1 Prepare to Remove the Door – JK 2007 Vehicles Only (earlier models skip to Step 3)

Roll the window completely down.

Fold in the mirror.

Locate the door electrical connector (under the dashboard or behind a panel near the front passenger seat belts). Disconnect the connector by sliding the red part and pulling, as shown below.

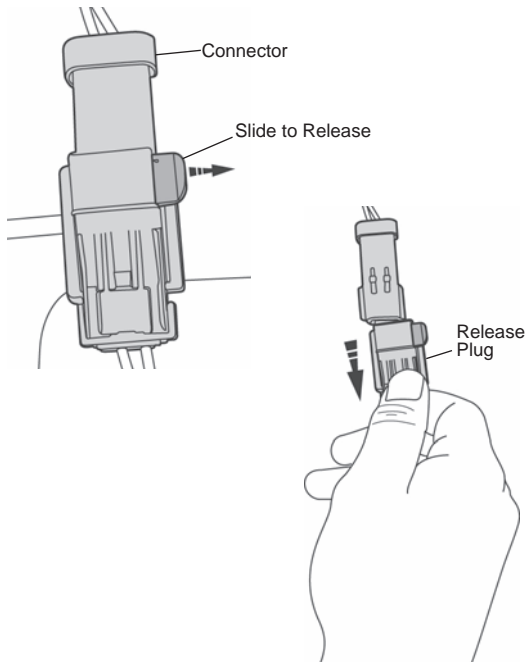

2 Prepare to Remove the Door – JK 2007 Vehicles Only (earlier models skip to Step 3)

Use a T40 Torx wrench to remove the nuts under the hinges.

Slip the security strap off the pin inside the door.

Remove Nuts from Hinges

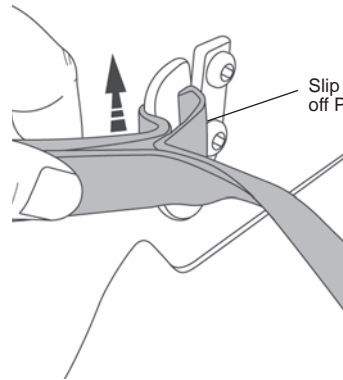
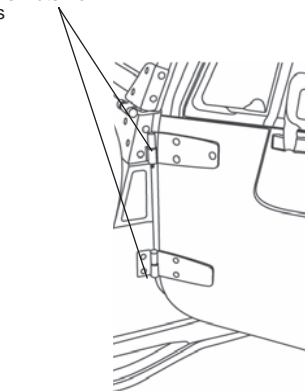

Slip Strap off Pin

3 Prepare to Remove the Door (JK models skip to Step 4)

Roll the window completely down.

Fold in the mirror.

Use an adjustable wrench to remove the nuts under the hinges.

Slip the security strap off the pin inside the door.

Remove Nuts from Hinges

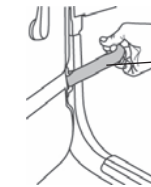
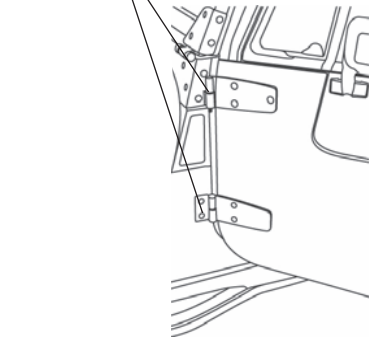

Slip Strap off Pin

Door Jackets – Installation Instructions

! WARNING The doors can weigh in excess of 50 lbs. Please handle with caution.

4 Removing the Door (option 1)

Slip the Door Jacket over the door and close the zippers as far as possible. The jacket may be oriented with the two straps either to the inside or outside of the door.

Lift up and out using the two handles, raising the door until the pins are free of the hinges. Lower gently to the ground.

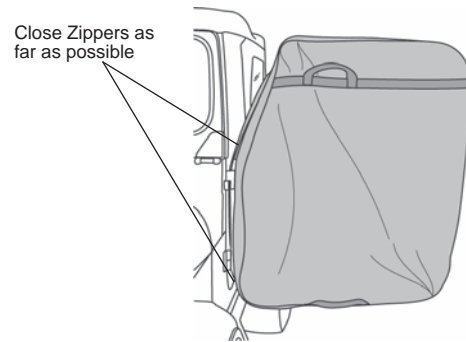

NOTE If removing Lower Steel Door with Soft Upper, always lift the door from the bottom, grasping the steel door section.

! WARNING The doors can weigh in excess of 50 lbs. Please handle with caution.

5 Removing the Door (option 2) - 2 People

Lift the door up and out of the hinges.

While one person holds the Door Jacket open, place the door into the jacket.

NOTE If removing Lower Steel Door with Soft Upper, always lift the door from the bottom, grasping the steel door section.



6 Close Zippers (both options)

Close the zippers completely with the zipper pulls at the bottom corner of the door.

7 Transporting and Storing the Door

Always carry the Door Jackets with the top of the door up. Do not slide the Door Jacket across the ground.

Store door upright standing on the ground.



Door Jackets – Installation Instructions

Care and Maintenance of your Door Jacket

Your Door Jacket is made of the finest materials available. To keep it looking new and for the maximum possible wear, it will need periodic cleaning and maintenance.

Washing: The fabric should be washed often using soap, warm water and a soft bristle brush. Rinse with clear water to remove all traces of soap.

Zippers: Keeping the zipper cleaned and lubricated with a silicone lubricant will help prevent damage and keep the zippers in a smooth working condition. If a zipper opens behind the slider, the slider may have been spread apart. This problem can usually be repaired by using an ordinary pair of pliers to bring the sides back into parallel. Return slider to the end of the zipper in the normal Open position. Squeeze lightly at first and test the zipper. If the zipper continues to remain open squeeze more firmly with the pliers and try the zipper again. Repeat this procedure until the zipper operates correctly.

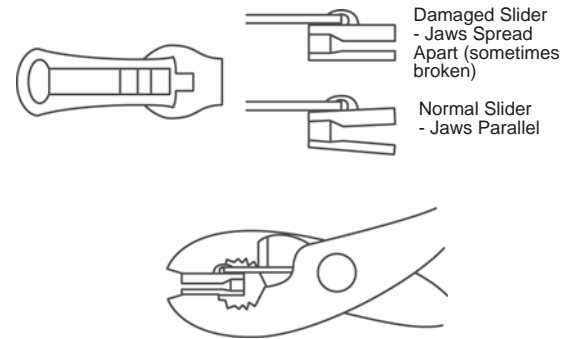

Limited Warranty

We warrant our product to be free from defects in material and workmanship, for the terms specified below, provided there has been normal use and proper maintenance. This warranty applies to the original purchaser only. All remedies under this warranty are limited to the repair or replacement of any item or items found by the factory to be defective within the time period specified.

If you have a warranty claim, first you must call our factory at the number below for instructions. You must retain proof of purchase and submit a copy with any items returned for warranty work. Upon completion of warranty work, if any, we will return the repaired or replaced item or items to you freight prepaid. Damage to our products caused by accidents, fire, vandalism, negligence, misinstallation, misuse, Acts of God, or by defective parts not manufactured by us, is not covered under this warranty.

THE WARRANTY TIME PERIOD IS AS FOLLOWS: ALL "SOFT GOODS" MANUFACTURED BY OUR COMPANY (USING PRIMARILY VINYL, PLASTICS, AND/OR FOAM): ONE YEAR FROM DATE OF PURCHASE.

ANY IMPLIED WARRANTIES OF MERCHANTABILITY AND/OR FITNESS FOR A PARTICULAR PURPOSE CREATED HEREBY ARE LIMITED IN DURATION TO THE SAME DURATION AND SCOPE AS THE EXPRESS WRITTEN WARRANTY. OUR COMPANY SHALL NOT BE LIABLE FOR ANY INCIDENTAL OR CONSEQUENTIAL DAMAGE.

Some states do not allow limitations on how long an implied warranty lasts, or the exclusion or limitation of incidental or consequential damages, so the above limitations or exclusions may not apply to you.

This warranty gives you specific legal rights, and you may also have other rights which vary from state to state.



For further information or request for warranty work, please contact:
Bestop Inc. Customer Service
(800) 845-3567
(303) 465-1755

NOTE: All or a portion of this product may be made in China.