



## Installation Instructions

For Part Numbers:

200-207	700-422 Airaid Oiled Media Filter
201-207	701-422 SynthaMax Dry Media Filter - Red
202-207	702-422 SynthaMax Dry Media Filter - Black
203-207	703-422 SynthaMax Dry Media Filter - Blue

1999-00 Cadillac Escalade  
 1996-99 Chevrolet/GMC C/K Pickup 1500  
 1996-00 Chevrolet/GMC C/K Pickup 2500/3500  
 1996-99 Chevrolet/GMC C/K Suburban 1500/2500  
 1999-00 Chevrolet Silverado/GMC Sierra 1500  
 1996-00 Chevrolet Tahoe/GMC Yukon  
 1997-00 Isuzu Hombre

## Component Identification

1.	Airaid Premium Filter	1
2.	MAF Panel	1
3.	Bottom Panel	1
4.	End Panel	1
5.	Airaid Intake Tube	1
6.	Stainless Steel Coupler	1
7.	Weather Strip 25 1/4"	1
8.	1/4" Flat Washer	1
9.	#6 Flat Washer	9
10.	6-32 x 5/16" Phillips Screw	9
11.	6-32 Keps Nut	9
12.	3" x 2" Plate	1
13.	5/16-18 x 1" Hex Bolt	2
14.	5/16" Flat Washer	2
15.	5/16" Nylock Nut	2
16.	1/4-20 x 1/2" Hex Bolt	1
17.	1/4-20 Serrated Nut	1
18.	Rubber Trim 12 1/2"	1

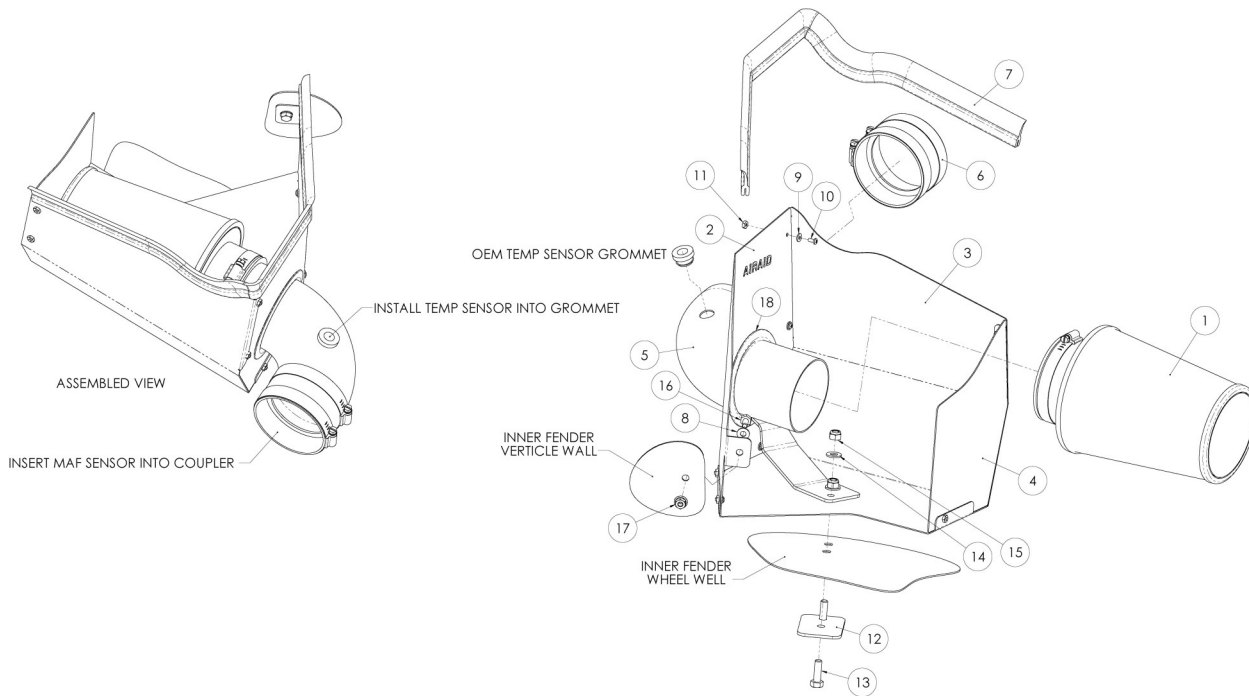

Full color instructions can be viewed on our web site at [Airaid.com](http://Airaid.com). Use the **Product Search** function to find your part number, and click **View Details**.

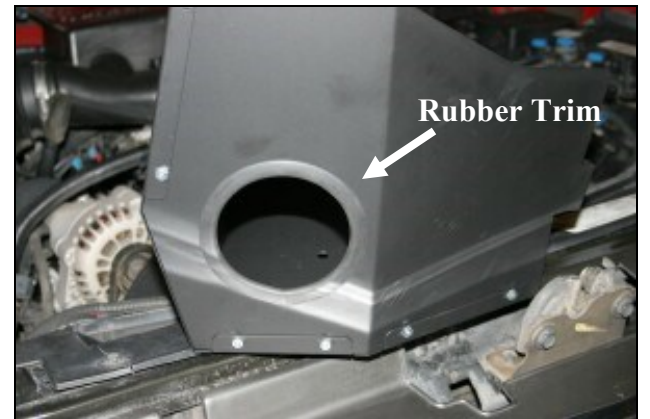
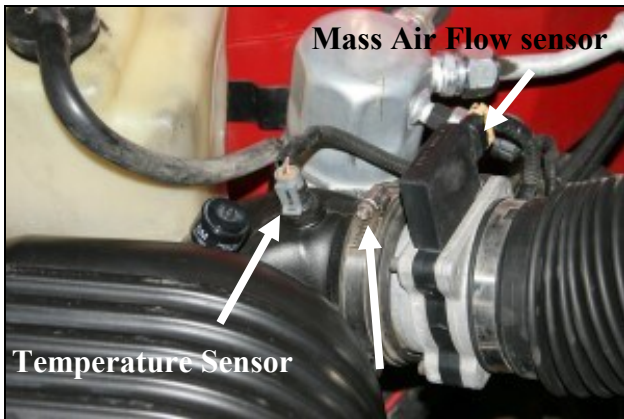

1. **Disconnect the negative battery cable.** **VERY CAREFULLY!** Remove the air intake temperature sensor first, and then the grommet from the air intake tube and set them aside. *There is no need to disconnect the wiring harness on the temp sensor.* Loosen the hose clamp that secures the air intake tube to the Mass Air Flow (MAF) sensor. Disconnect the MAF sensor from the intake tube and then remove the airbox from the vehicle.

2. Assemble the three Cold Air Dam (CAD) panels (#s 2, 3, & 4) as shown using nine 6-32 screws (#10), nine #6 washers (#9), and nine nuts (#11).

3. Install the supplied rubber trim (#18) into the hole in the MAF Panel (#2) as shown.

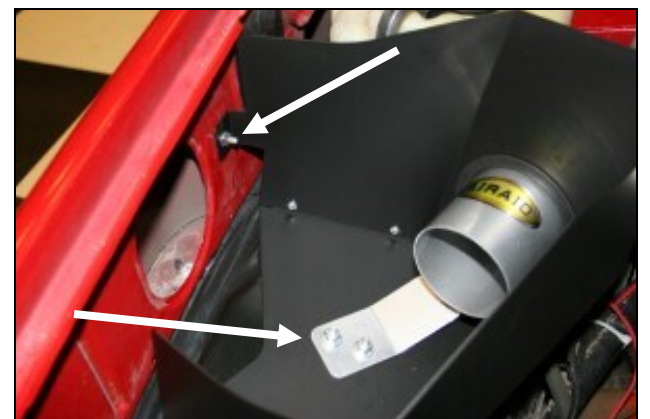
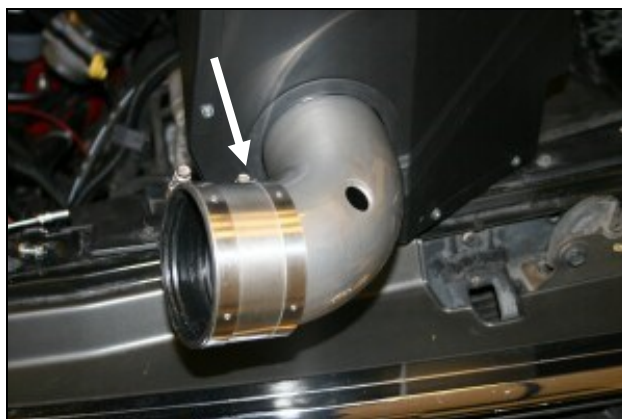

4. Insert the Airaid intake tube (#5) thru the hole in the MAF panel and then rotate it clockwise so that the holes in the bracket on the tube line up with the two holes in the bottom panel.

5. Install the stainless steel coupler (#6) onto the Airaid intake tube and tighten *only* the hose clamp on the tube.

6. Install the CAD/Tube assembly into the vehicle as shown using two 5/16" x 1" bolts (#13) thru the 3" x 2" plate (#12) up thru the fender well, thru the CAD, and thru the bracket on the intake tube, secured with two 5/16" flat washers (#14) and two 5/16" nylock nuts (#15). Next secure the CAD to the side fender well using one 1/4" hex bolt (#16), 1/4" flat washer (#8), and 1/4" serrated nut (#17). Refer to the line drawing above if needed.

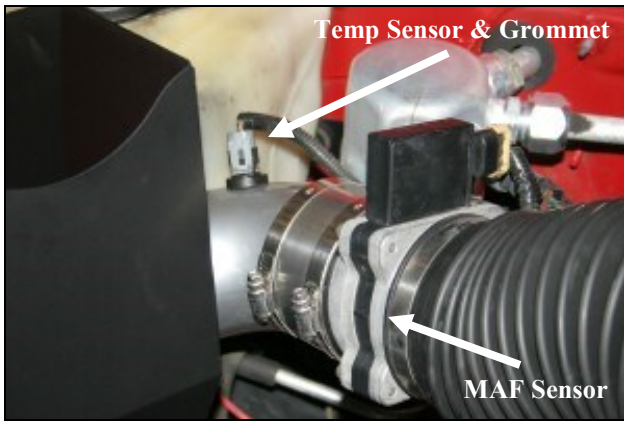

7. Connect the **MAF** sensor to the stainless steel coupler and tighten the hose clamp. Install the factory grommet removed in step #1, into the hole in the Airaid intake tube. **VERY CAREFULLY** install the factory temperature sensor into the grommet.

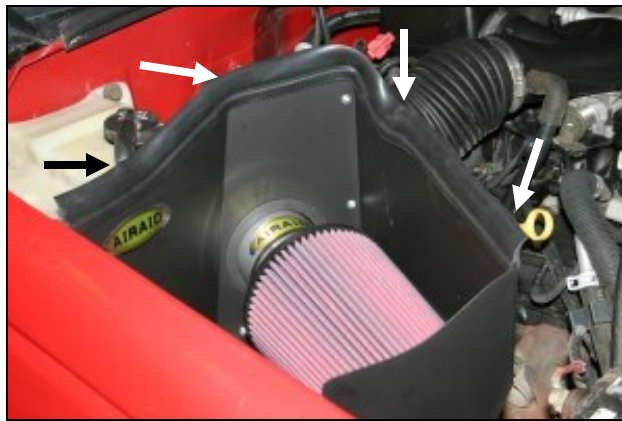

8. Install the Airaid Premium Filter (#1) onto the Airaid intake tube as shown, and then tighten the hose clamp. Next, install the weather strip on top of the CAD, starting at the right fender working your way towards the front of the vehicle.

**9. Double check your work!**

Make sure there is no foreign material in the intake path. Make sure all clamps, hoses, bolts, connectors, and screws are tight.

**10. Reconnect the negative battery cable!**

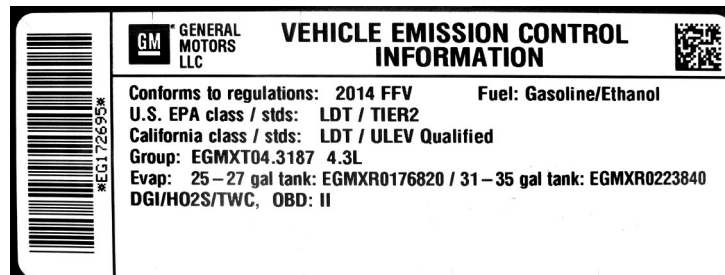

**WARNING!** If your vehicle has a Vehicle Emission Control Information decal affixed to the factory airbox, a new replacement label must be obtained and installed in a readily visible position in the engine compartment in order to remain CARB compliant. Failure to do so will prevent the vehicle from passing a smog check. Replacement labels can be ordered from your local dealership. Regulations state that the VECI label shall not be affixed to any equipment which is easily detached from the vehicle. Label placement, under the hood on a painted surface is recommended.

Thank you for purchasing the Airaid Intake System. Contact Airaid @ (800) 498-6951 8:00 AM - 5:00 PM MST weekdays for questions regarding fit or instructions that are not clear to you. Your Airaid Intake System was carefully inspected and packaged. Check that no parts are missing, or were damaged during shipping. If any parts are missing, contact Airaid. The air filter element is protected from direct exposure to water and debris; care should be taken not to drive through deep water. WATER INGESTION IS THE DRIVERS RESPONSIBILITY! The air filter is reusable and should be cleaned periodically.

**FILTER IDENTIFICATION**

700-422 Airaid Oiled Media  
702-422 Airaid SynthaMax Dry Media - Black

701-422 Airaid SynthaMax Dry Media - Red  
703-422 Airaid SynthaMax Dry Media - Blue

**For your Oiled media filter we suggest using the AIRAID Filter Tune-Up Kit!**



P/N 790-551 Aerosol Spray  
P/N 790-550 Squeeze Spray



**Do Not Oil**

Synthamax Air Filters do not require oil. Service air filter as needed by cleaning with common non-petroleum all-purpose household cleaner and water. Simple Green®, Formula 409® or equivalent works great. Apply cleaner to outside of air filter and allow to soak. Then flush filter clean from the inside out with a garden hose and repeat steps if necessary. Do not apply high pressure water or air to clean filter. Allow filter to air dry and reinstall.