

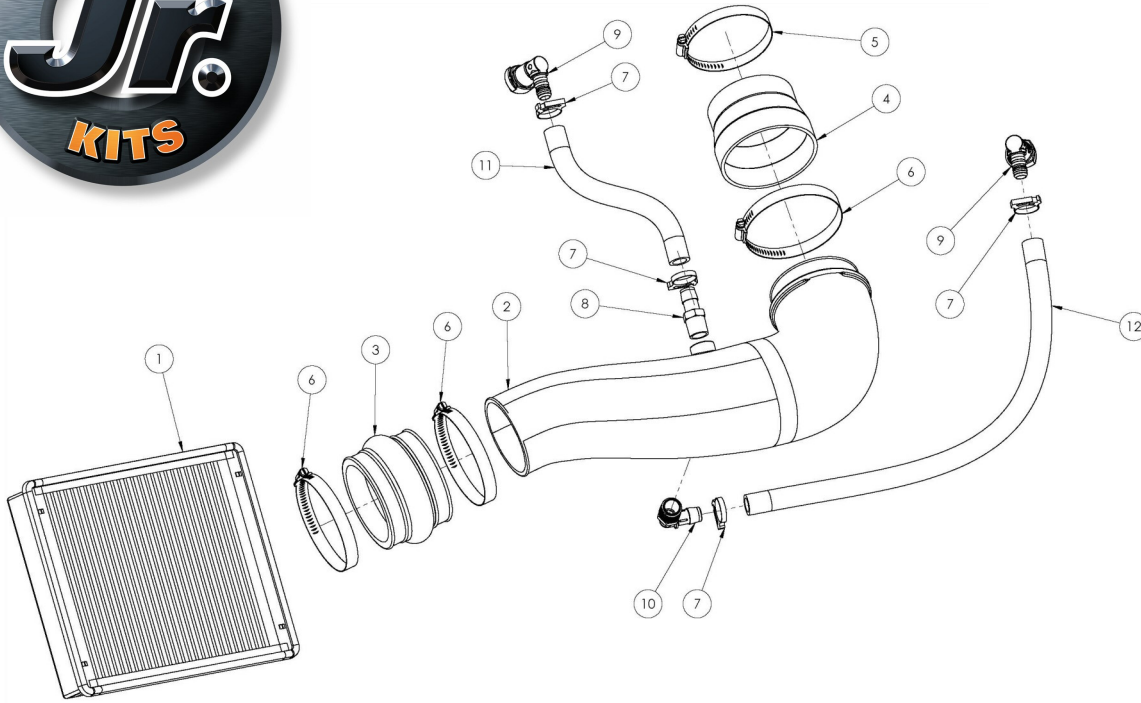

Installation Instructions
For Part Numbers:

- 200-985 Modular Intake Tube
- 200-785 Jr. Kit 850-135 Airaid Oiled Media Filter
- 201-785 Jr. Kit 851-135 SynthaMax Dry Media Filter - Red

- 2014-15 Chevrolet Silverado 1500/ GMC Sierra
- 2015 Chevrolet Tahoe/ GMC Yukon
- 2015 Chevrolet Suburban 1500
- 5.3L V8



Component Identification

1	Airaid Premium Filter	1
2	Airaid Intake Tube	1
3	Hump Hose	1
4	Reducing Coupler	1
5	#56 Hose Clamp	1
6	#64 Hose Clamp	3
7	Speed Clamp	4
8	Barbed Fitting	1
9	Quick Connector	2
10	Barbed Elbow Fitting	1
11	10 1/2" Breather Hose	1
12	23 1/2" Breather Hose	1

Full color instructions can be viewed on our web site at Airaid.com. Use the **Product Search** function to find your part number, and click **View Details**.

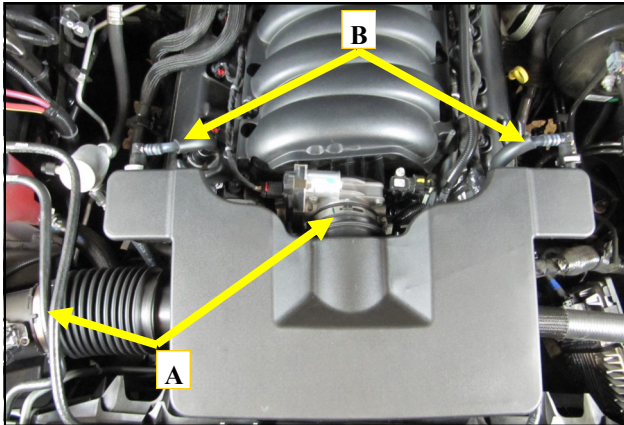

1. Disconnect The Negative Battery Terminal!
A.) loosen the clamps securing the intake system to the throttle body and the air box.
B.) Disconnect the valve cover breathers from either side of the factory intake System. Remove the factory intake system and set it aside.

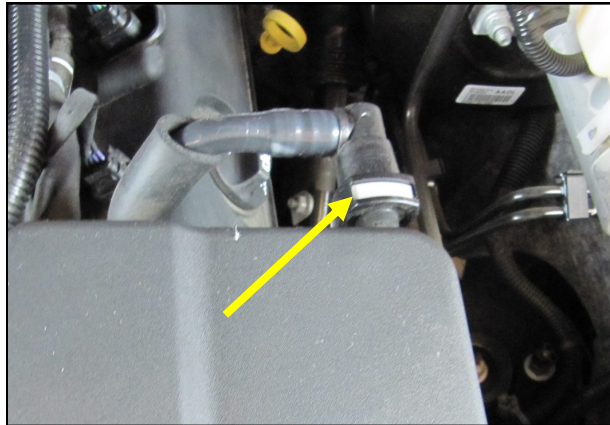

2. The quick connects for the valve cover breathers are removed by depressing the grey locking tab in the fitting and sliding them off.

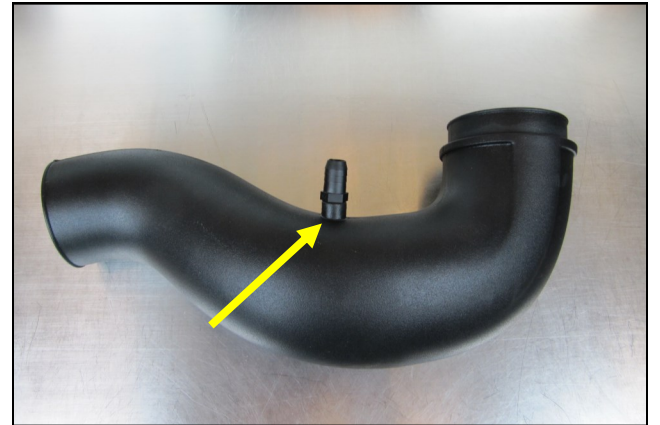

3. Install the Barbed Fitting into the Intake Tube as shown.

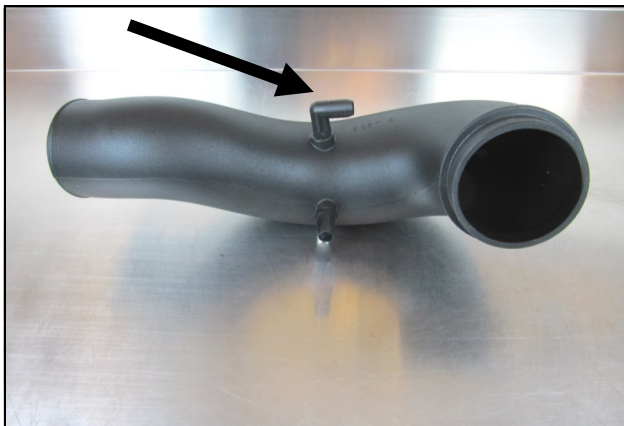

4. Install the 90 deg. Barbed fitting into the Intake Tube exactly as shown.

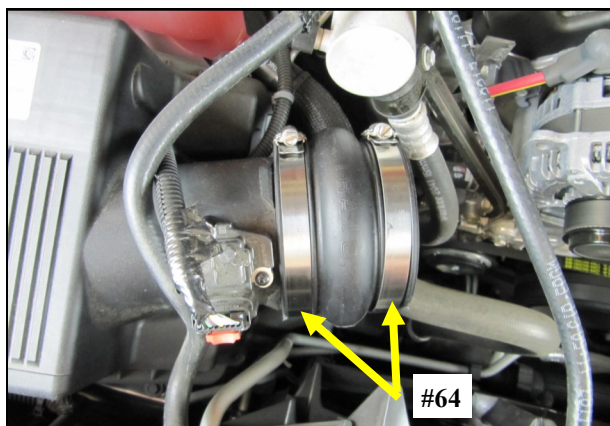

5. Slide the Hump Hose and two #64 Clamps onto the factory air box. If you are installing an Airaid Jr. kit, install the Airaid Premium Filter at this time.

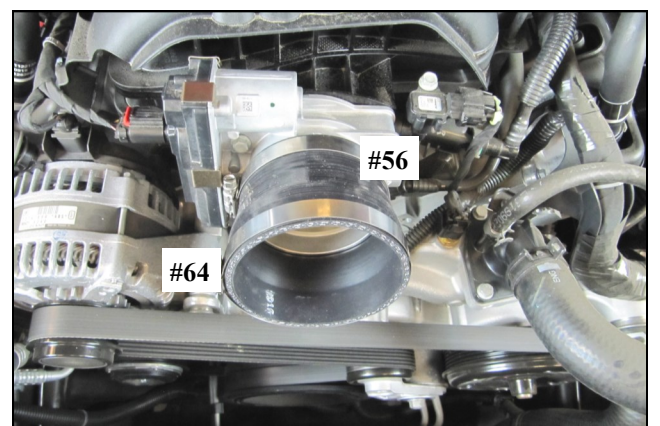

6. Slide the Reducer and the #56 and 64 clamps onto the throttle body.

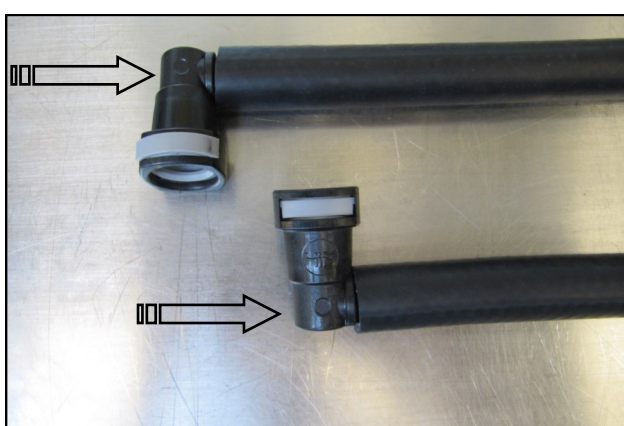

7. Insert the new Quick Connect Fittings into the supplied Breather Hoses.

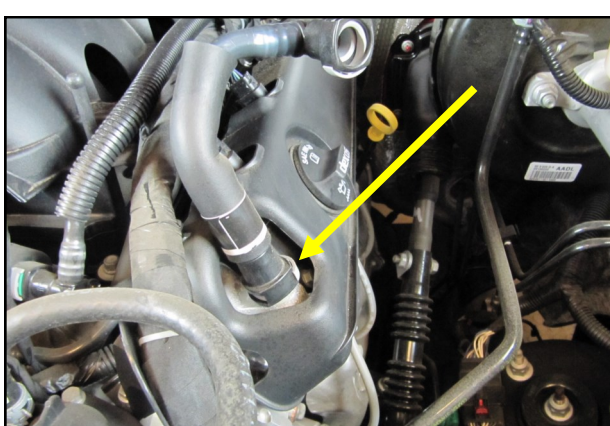

8. Remove the valve cover breathers from both sides of the motor and set them aside. They will not be reused.



9. Install the Intake Tube and tighten the Clamps. Connect the new breathers to the Barbed Fittings in the Intake tube and the Quick Connect Fittings to the Valve covers.

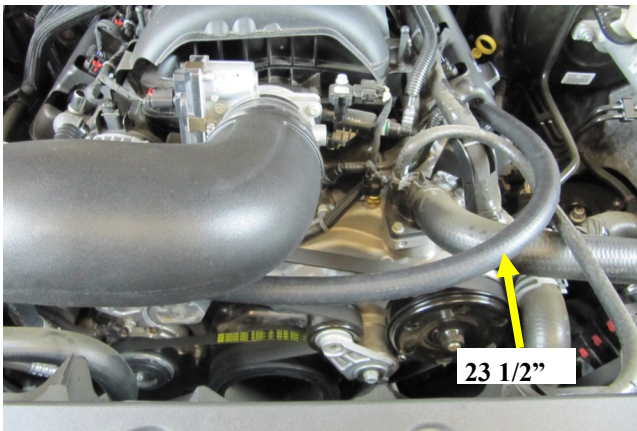

10. The 23 1/2" Hose is to be on the Drivers side. As shown.

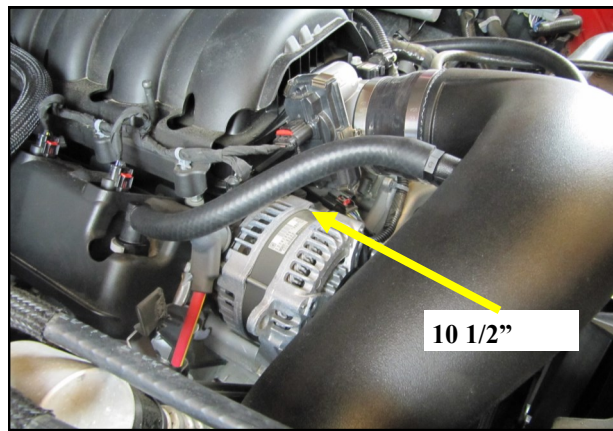

11. The 10 1/2" Hose is to be used on the Passenger side as shown.

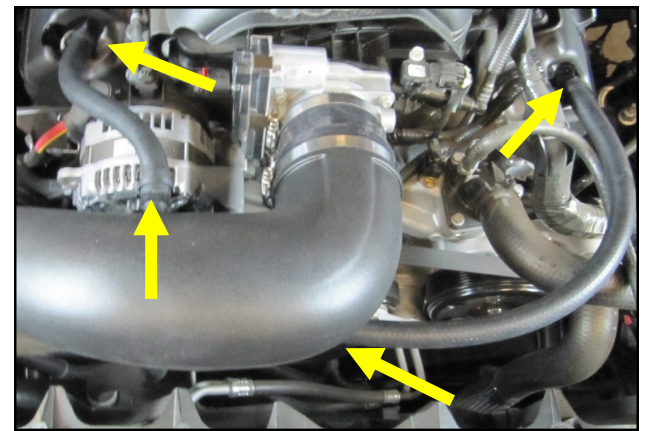

12. Secure the hose ends with the supplied Speed Clamps.



13. Double check your work. Make sure all Clamps are tight and reconnect the negative battery cable.

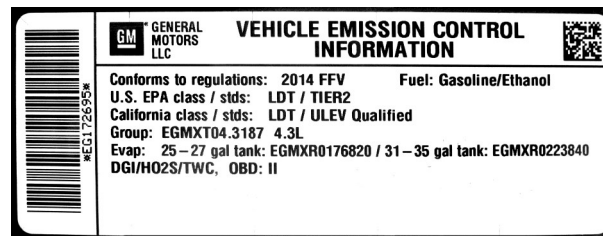

WARNING! If your vehicle has a Vehicle Emission Control Information decal affixed to the factory air box and it is removed, a new replacement label must be obtained and installed in a readily visible position in the engine compartment in order to remain CARB compliant. Failure to do so will prevent the vehicle from passing a smog check. Replacement labels can be ordered from your local dealership. Regulations state that the VECI label shall not be affixed to any equipment which is easily detached from the vehicle. Label placement, under the hood on a painted surface is recommended.

Thank you for purchasing the Airaid Intake System. Contact Airaid @ (800) 498-6951 8:00 AM - 5:00 PM MST weekdays for questions regarding fit or instructions that are not clear to you. Your Airaid Intake System was carefully inspected and packaged. Check that no parts are missing, or were damaged during shipping. If any parts are missing, contact Airaid. The air filter element is protected from direct exposure to water and debris; care should be taken not to drive through deep water. WATER INGESTION IS THE DRIVERS RESPONSIBILITY! The air filter is reusable and should be cleaned periodically.

FILTER IDENTIFICATION

720-472 Airaid Oiled Media

721-472 Airaid SynthaMax Dry Media - Red

For your Oiled media filter we suggest using the AIRAID Filter Tune-Up Kit!

SynthaMax

Do Not Oil



P/N 790-551 Aerosol Spray
P/N 790-550 Squeeze Spray



Synthamax Air Filters do not require oil. Service air filter as needed by cleaning with common non-petroleum all-purpose household cleaner and water. Simple Green®, Formula 409® or equivalent works great. Apply cleaner to outside of air filter and allow to soak. Then flush filter clean from the inside out with a garden hose and repeat steps if necessary. Do not apply high pressure water or air to clean filter. Allow filter to air dry and reinstall.