



Installation Instructions

For Part Numbers:

350-210	720-243 Airaid Oiled Media Filter
351-210	721-243 SynthaMax Dry Media Filter - Red
352-210	722-243 SynthaMax Dry Media Filter - Black
353-210	723-243 SynthaMax Dry Media Filter - Blue

**2011-14 Chrysler 300, Dodge Challenger and Charger
3.6L V6, 5.7L V8 and 6.4L V8 SRT**

Component Identification

1.	Airaid Premium Filter	1
2.	V6 Airaid Intake Tube	1
3.	V8 Airaid Intake Tube	1
4.	Rear Panel	1
5.	Front Panel	1
6.	Filter Adapter	1
7.	Hump Hose	1
8.	22" Weather strip	1
9.	8 1/2" Edge Seal	2
10.	3/4" Hose	1
11.	5/8" Hose	1
12.	1/4-20 x 1/2" Button Head Bolt	4
13.	1/4" Flat Washer	4
14.	3/8-16x 1 1/4" Bolt	1
15.	Flat Washer	1
16.	#6 Flat Washer	2
17.	#6-32 Kep Nut	2
18.	#6-32 x 5/16" Pan Head Screw	2
19.	3/8-16 Well Nut	1
20.	#72 Hose Clamp	2
21.	#19 Speed Clamp	2
22.	Line Holder	1
23.	3/4" Grommet	1
24.	5/8" Grommet	1
25.	3/4" Barbed Fitting	2
26.	3/4" Barbed 90 Deg. Fitting	1
27.	5/8" Straight Fitting	1

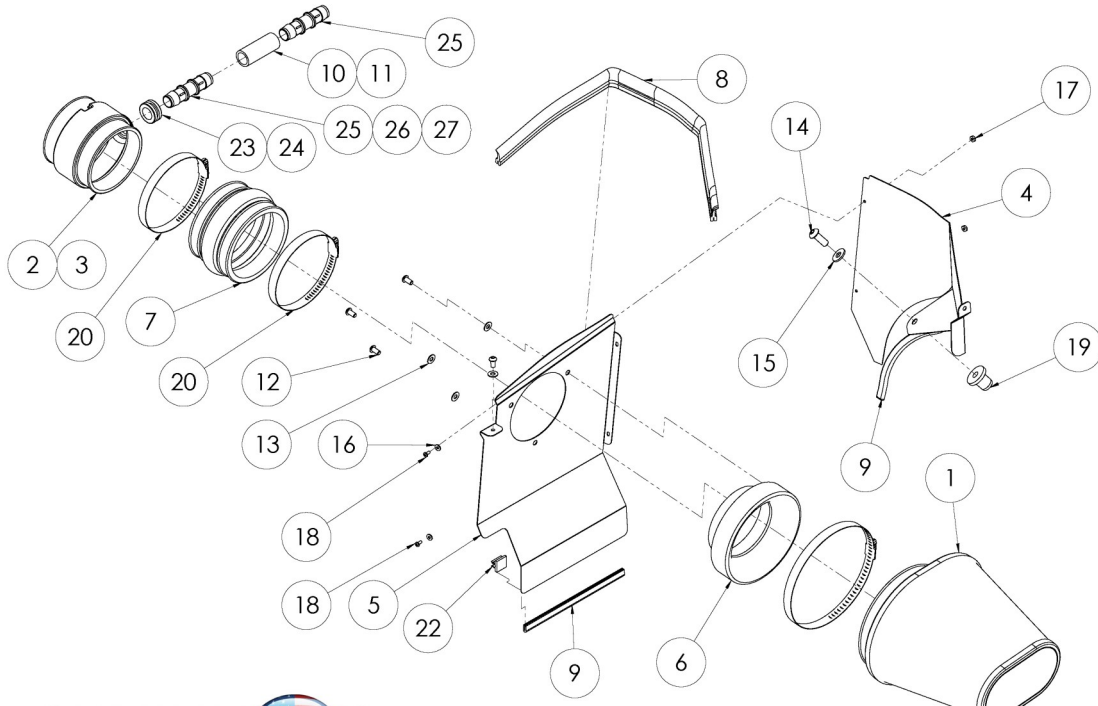

NOTE: These instructions illustrate installations being performed on all three motors available. While some details may vary from vehicle to vehicle, the general install procedure remains the same. Removal of the engine cover is not mandatory, but recommended as it will make installation easier on some models.

Full color instructions can be viewed on our web site at Airaid.com. Use the **Product Search** function to find your part number, and click **View Details**.

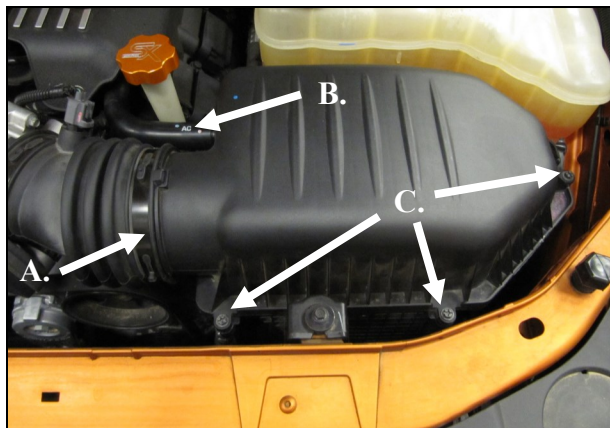

1. **Disconnect The Negative Battery Terminal!**
- A. Loosen the hose clamp on the factory intake tube.
- B. Disconnect the crank case breather line from the airbox top.
- C. Remove the three airbox top screws and remove the airbox lid and filter.



2. Remove the core support bolt securing the lower half of the airbox and remove it from the vehicle.



3. Carefully remove the speed clip from the core support tab and set it aside. It will not be reused.

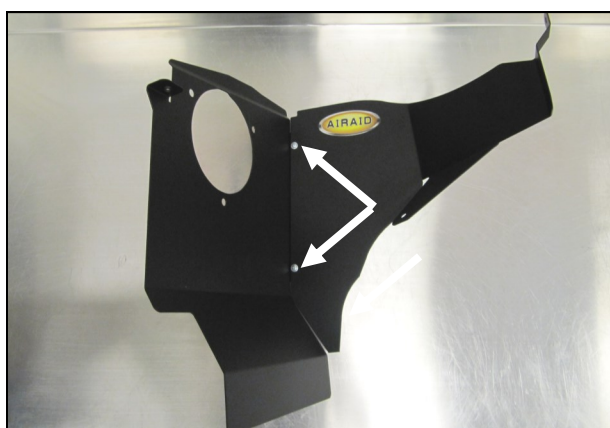

4. Create the panel assembly. Join the Front (#5) and Rear (#6) panels together using the two #6-32 Screws (#18), #6 Flat Washers (#16), and #6 Kep Screws (#17). Note: The Tab on the Front Panel is to be behind the Rear panel when properly installed.

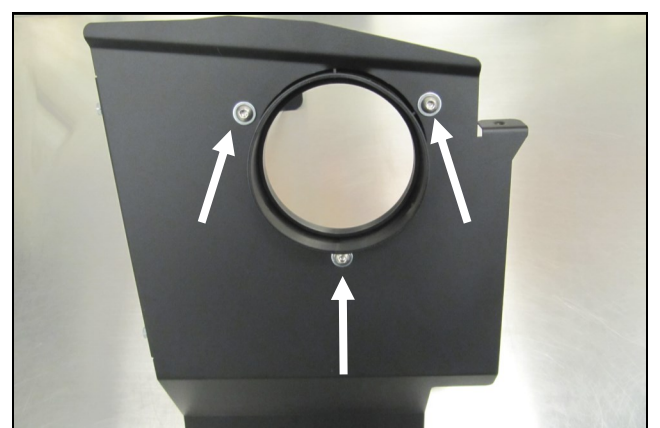

5. Install the Filter Adapter (#6) onto the Front Panel as shown using three 1/4-20 Button Head Screws (#12) and 1/4" Flat Washers (#13).

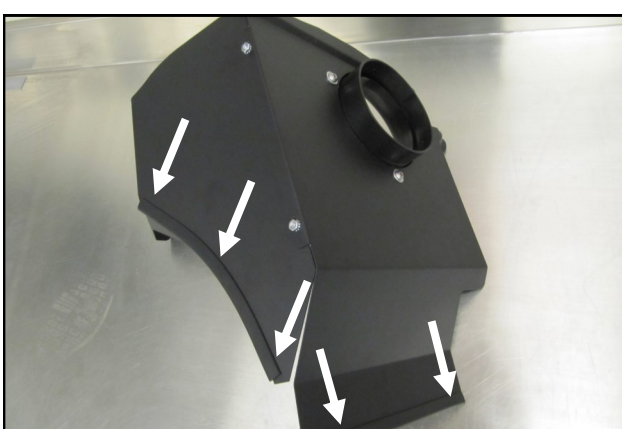

6. Install one piece of the Edge Seal (#9) on the curved edge of the Rear Panel and the other piece on the bottom of the Front Panel.

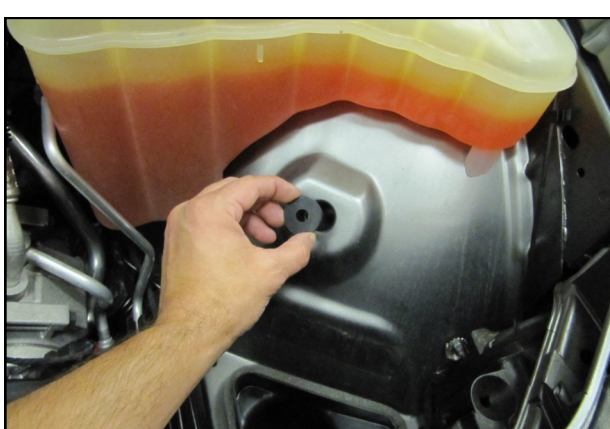

7. Place the 3/8" Well Nut into the hole in the inner fender. It will be fully secured later in step 9.

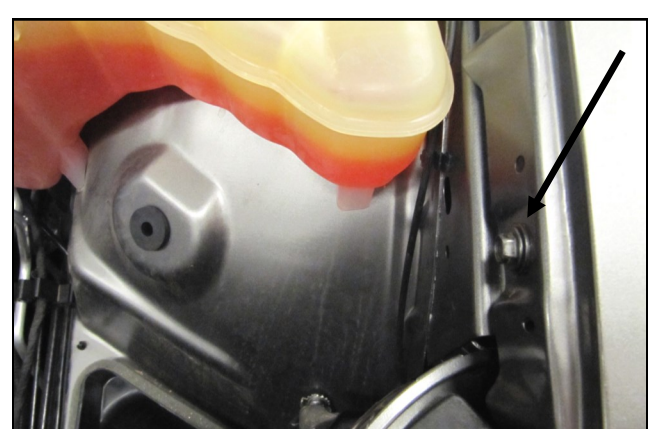

8. Remove and save the factory 6mm fender bolt. It will be reused in step 9.



9. Lower the Panel Assembly into the inner fender area and align the mounting holes. Be sure to insert the bottom of Front Panel between the ABS line and the sheet metal. Secure the assembly using:
One, 1/4-20 Button Head bolt (#12) and 1/4" Flat Washer (#13), Underneath the factory core support tab (A), The 3/8 Button Head Bolt (#14) and Flat Washer (#15) in the Well Nut (B), and the factory fender bolt from step 8 (C).

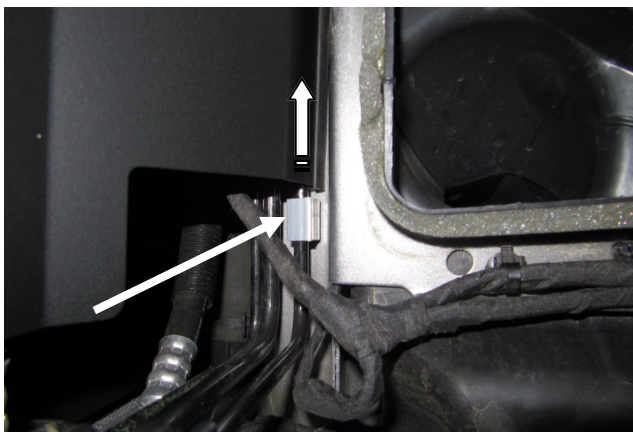

10. Snap the Line Holder (#22) onto the ABS line closest to the panel assembly and remove the adhesive backing. Gently push the Panel away from the line and slide the Line Holder behind the Panel. Relax the Panel, and allow the Adhesive pad to bond the Panel. This will isolate the Panel and prevent contact with the ABS line.



11. For 3.6L V6 Pentastar equipped vehicles: Locate the V6 Airaid Intake Tube marked KIT-210-6T and insert the smaller, 5/8" Grommet (#24) into the side. Complete the V6 Tube assembly by inserting the smaller, 5/8" Barbed fitting (#27) into the Grommet.

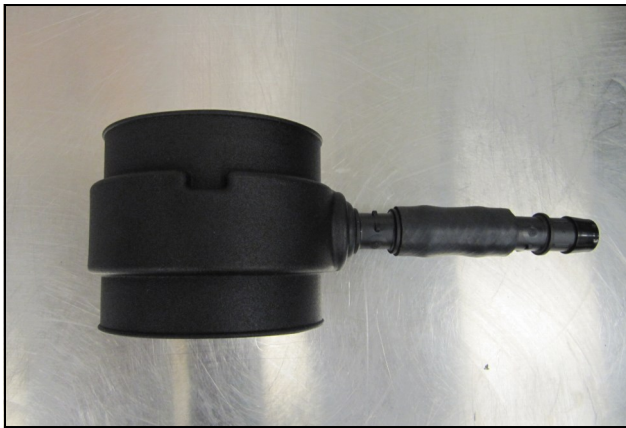

12. For 5.7L V8 HEMI equipped vehicles: Locate the V8 Airaid Intake Tube marked KIT-210-8T and insert the larger, 3/4" Grommet (#23) and one of the larger, 3/4" Barbed fittings (#25) into the side. Complete the V8 Tube assembly by installing the 2 1/2", 3/4" Hose (#10) onto the Tube Fitting, and inserting the second 3/4" Barbed Fitting into it as shown.



13. For 6.4L V8 SRT-8 equipped vehicles: Locate the V8 Airaid Intake Tube marked KIT-210-8T and insert the larger, 3/4" Grommet (#24) into the side. Complete the SRT-8 Tube assembly by inserting the 5/8" 90 Degree, Barbed Fitting (#26) into the Grommet as shown.

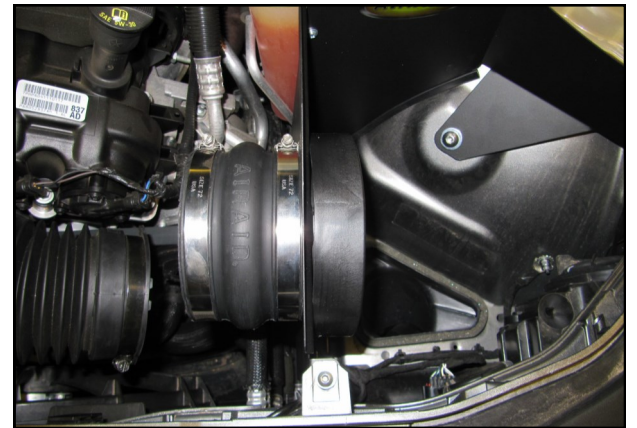

14. Install the Hump Hose (#7) and Clamps (#20) onto the Filter Adapter. Leave the Clamps loose for now.



15. Install the Intake Tube into the Hump Hose and factory intake tube. When properly installed the location lug in the factory tube will mate with the notch in the Airaid Intake Tube. Tighten the clamps and connect the crank case breather to the Intake Tube.

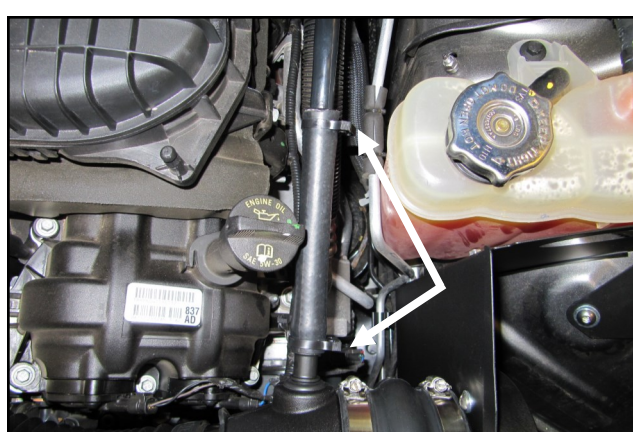

16. For 3.6L V6 Pentastar equipped vehicles: Install the Smaller, 5/8" hose (#11) onto the Barbed Fitting and factory hard line. Snap a Speed Clamp (21) on each end of the hose to secure it in place.



17. Install the Weatherstrip (#8) onto the top edge of the Panels with the contour rolling away from the Filter area. Complete the installation by attaching the Airaid Premium Filter (#1) to the Filter Adapter.

Double check your work!

Make sure there is no foreign material in the intake path. Make sure all clamps, hoses, bolts, and screws are tight. Double check the hood clearance!

Reconnect the negative battery cable!

Thank you for purchasing the Airaid Intake System. Contact Airaid @ (800) 498-6951 8:00 AM - 5:00 PM MST weekdays for questions regarding fit or instructions that are not clear to you. Your Airaid Intake System was carefully inspected and packaged. Check that no parts are missing, or were damaged during shipping. If any parts are missing, contact Airaid. The air filter element is protected from direct exposure to water and debris; care should be taken not to drive through deep water. WATER INGESTION IS THE DRIVERS RESPONSIBILITY! The air filter is reusable and should be cleaned periodically.

FILTER IDENTIFICATION

720-243 Airaid Oiled Media
722-243 Airaid SynthaMax Dry Media - Black

721-243 Airaid SynthaMax Dry Media - Red
723-243 Airaid SynthaMax Dry Media - Blue

For your Oiled media filter we suggest using the AIRAID Filter Tune-Up Kit!



P/N 790-551 Aerosol Spray
P/N 790-550 Squeeze Spray



SynthaMax

Do Not Oil

Synthamax Air Filters do not require oil. Service air filter as needed by cleaning with common non-petroleum all-purpose household cleaner and water. Simple Green®, Formula 409® or equivalent works great. Apply cleaner to outside of air filter and allow to soak. Then flush filter clean from the inside out with a garden hose and repeat steps if necessary. Do not apply high pressure water or air to clean filter. Allow filter to air dry and reinstall.