



Installation Instructions

For Part Number:

450-330

2015 Ford Mustang 2.3l EcoBoost 4 Cyl.

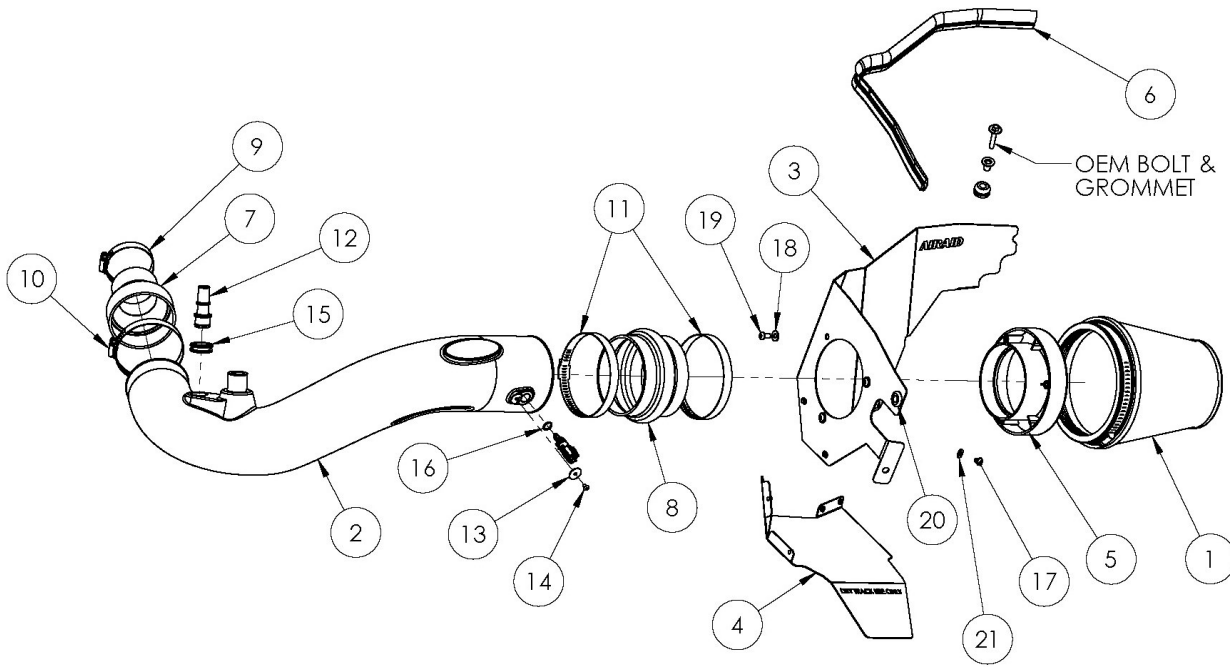

Component Identification

1	Airaid Track Day Filter	1
2	Airaid Intake Tube	1
3	Top Panel	1
4	Bottom Panel	1
5	Filter Adapter	1
6	Weatherstrip 23"	1
7	Coupler	1
8	Hump Hose	1
9	#40 Hose Clamp	1
10	#56 Hose Clamp	1
11	#68 Hose Clamp	2
12	5/8 Aluminum Fitting	1
13	#8 Flat Washer	1
14	1/4" Button Head Screw	1
15	13/16" Grommet	1
16	O-Ring	1
17	1/4"-20 Button Head Screw	4
18	1/4" Flat Washer	3
19	1/4"-20 Button Head Cap Screw	3
20	1/4" Lock Washer	4

Maximum performance potential requires custom tune.

Full color instructions can be viewed on our web site at Airaid.com. Use the **Product Search** function to find your part number, and click **View Details**.

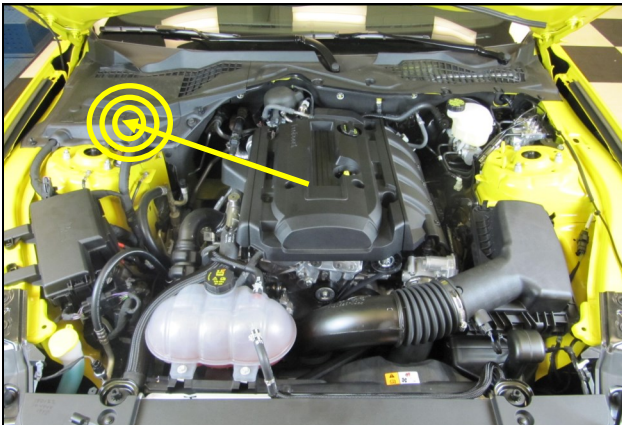

1. Remove the battery box cover in the cowl and disconnect the negative battery terminal.

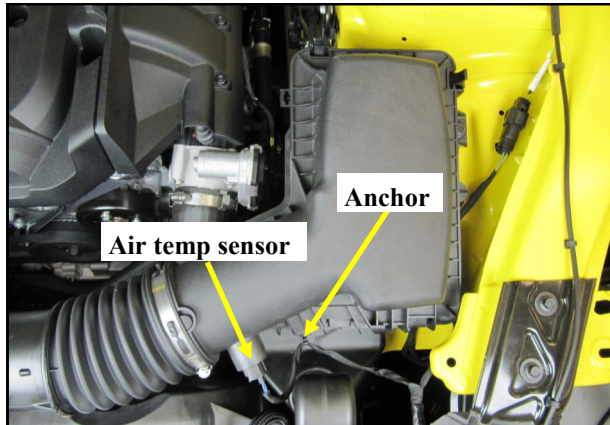

2. Loosen the clamp on the intake tube and slide it off of the airbox. Gently pry the harness anchor out of the airbox and disconnect the air temp sensor.

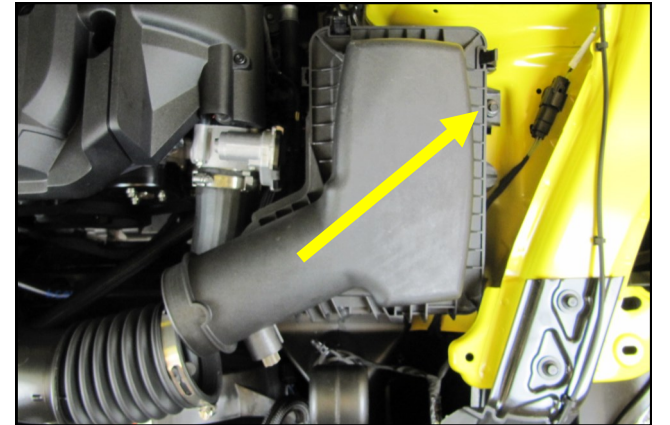

3. Remove the 6mm airbox mounting bolt in the inner fender and lift the entire airbox assembly out of the vehicle. Set the bolt aside for now. It is to be reused.

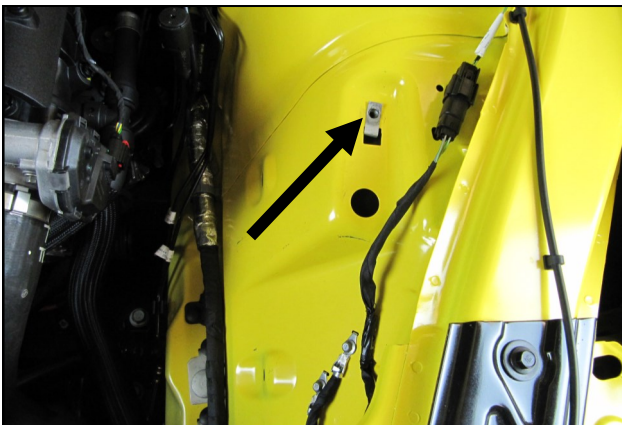

4. Be sure to retain speed clip in the inner fender .

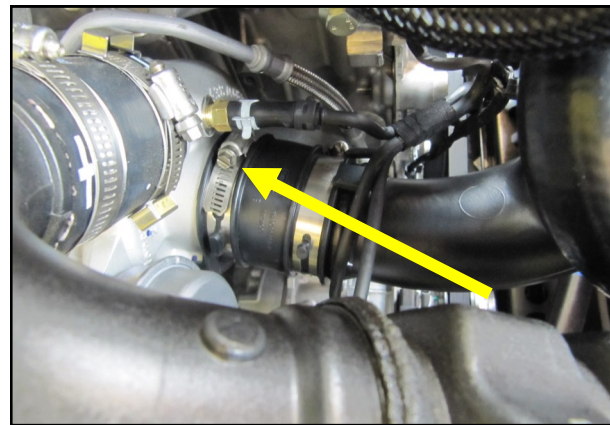

5. Loosen the clamp on the turbo inlet coupler.

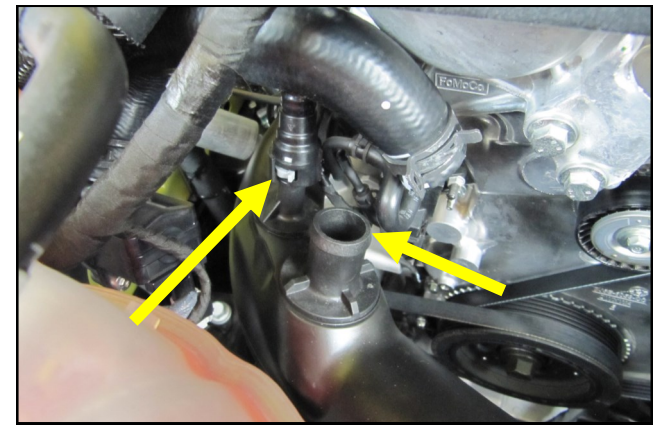

6. Disconnect the PCV and turbo bypass lines from the intake tube and remove the tube from the vehicle.

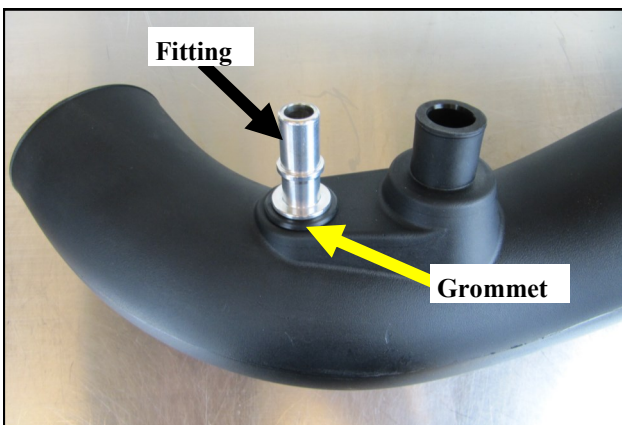

7. Insert the Grommet and Aluminum Fitting into the Airaid Intake tube as shown.

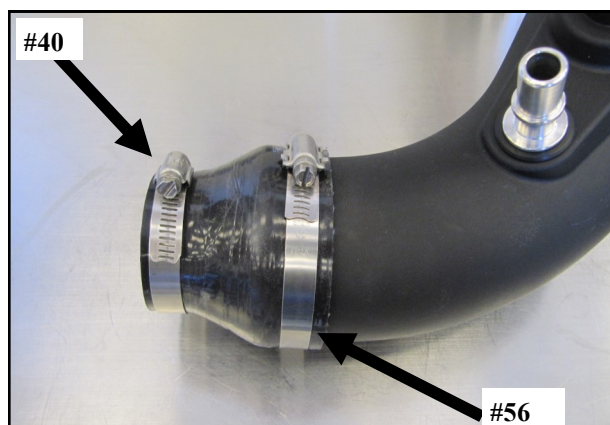

9. Slide the Reducer and Clamps onto the turbo side of the Intake Tube as shown. Leave the clamps loose for now.

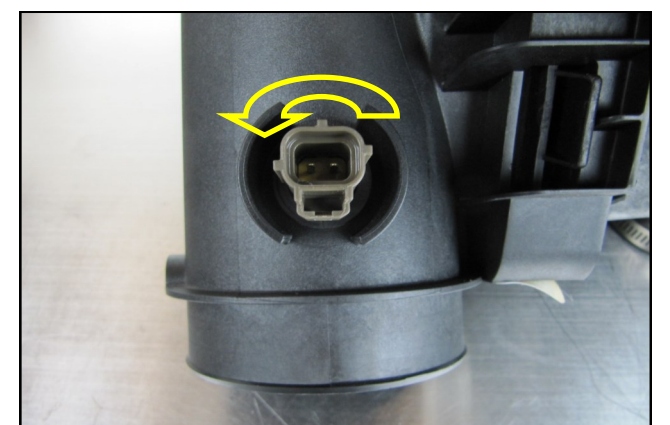

8. Tilt the air temp sensor rearward so the locking tab clears the ramp and rotate it counterclockwise 1/4 turn to release it.

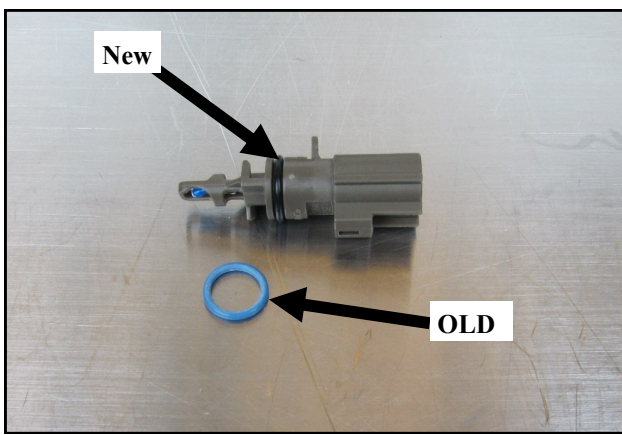

10. Replace the OEM O ring on the sensor with the supplied Airaid O ring.

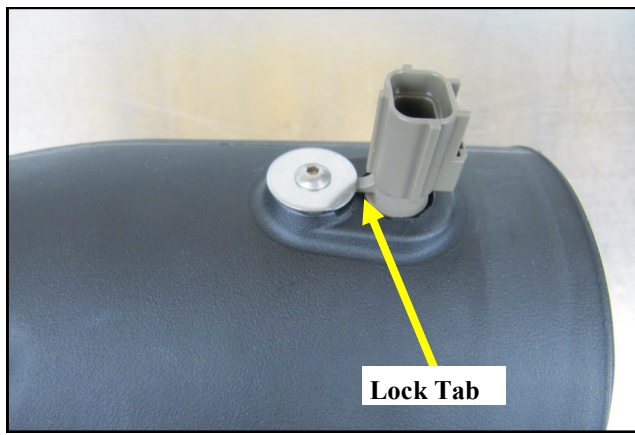

11. Insert the air temperature sensor into the Airaid intake tube as shown and secure it using the #8 Screw and Washer.

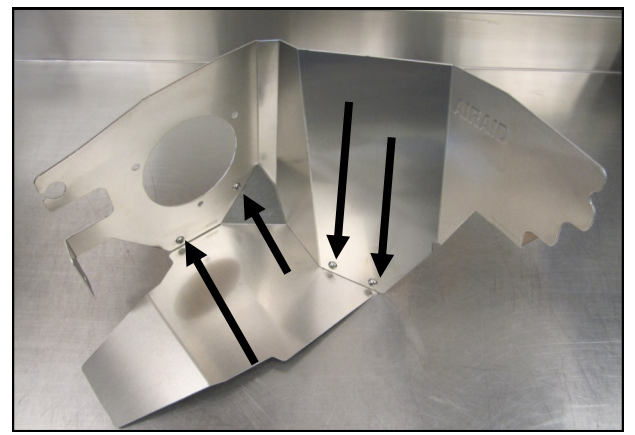

7. Remove the protective film from the Panels and create the assembly as shown using four 1/4 -20 Button Head Screws and Lock washers.

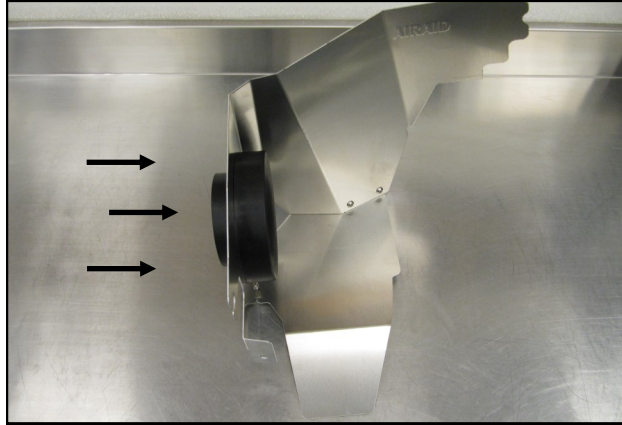

8. Install the Filter Adapter onto the Panel Assembly as shown, using the three 1/4-20 Button Head Screws and Flat Washers.



9. Transfer the OEM air box grommet and anti-crush sleeve into the Panel assembly as shown.

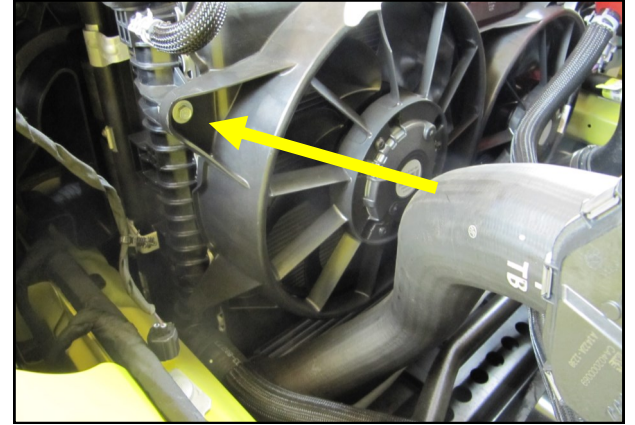

10. Remove the drivers side fan shroud bolt and set it aside.

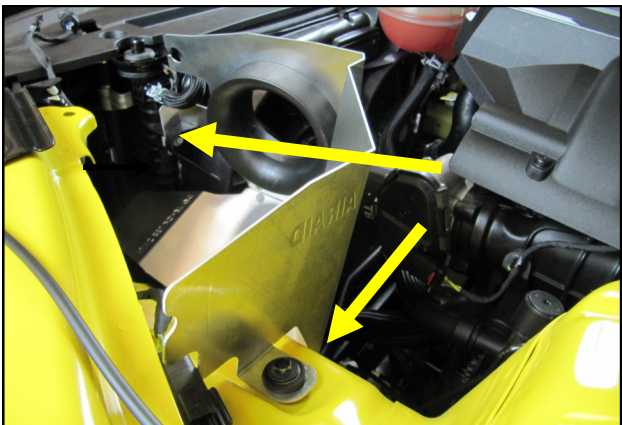

11. Install the Panel assembly into the engine compartment as shown and secure using the OEM hardware removed in steps 3 and 10.

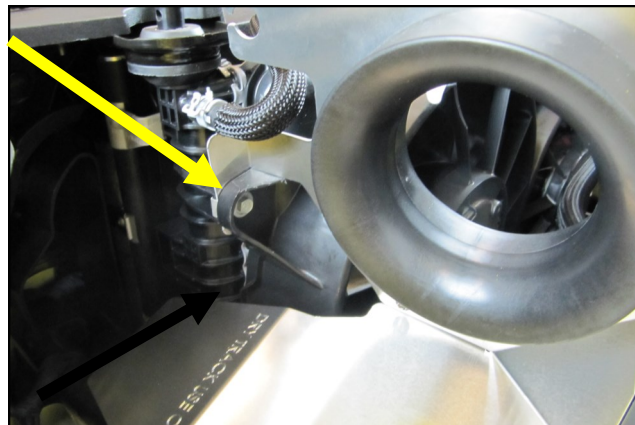

12. When properly installed, the Panel tab resides behind the fan shroud as shown.

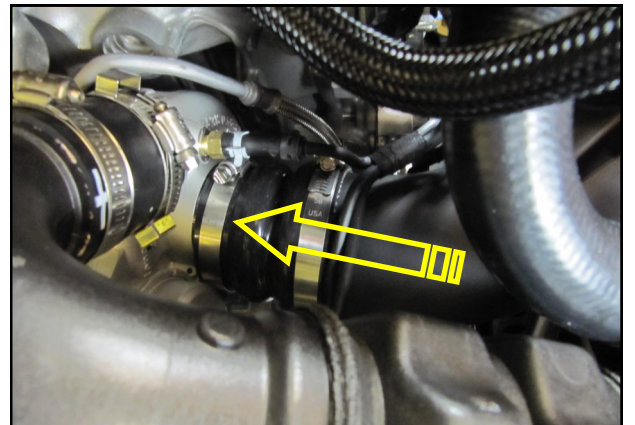

13. Lower the Airaid Intake tube down into position and slide the reducer onto the turbo inlet.

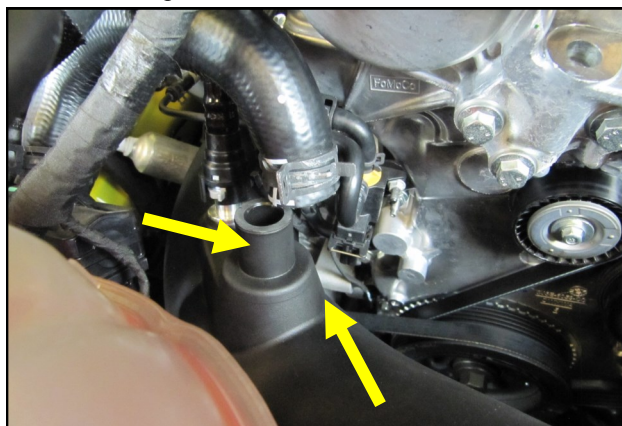

17. Reconnect the PCV and bypass line to the Airaid Intake Tube.

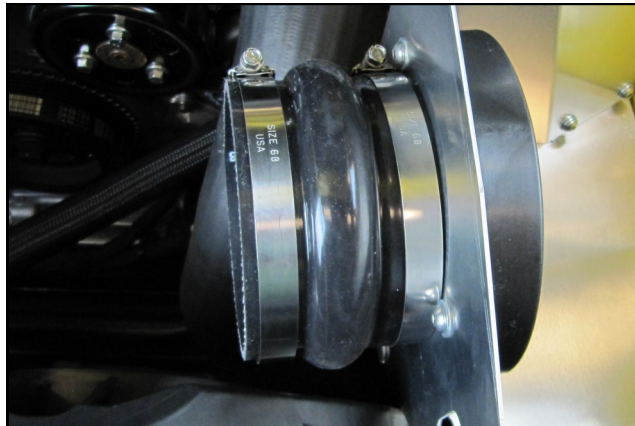

11. Slide the Hump Hose with two, #68 Clamps onto the Filter Adapter .

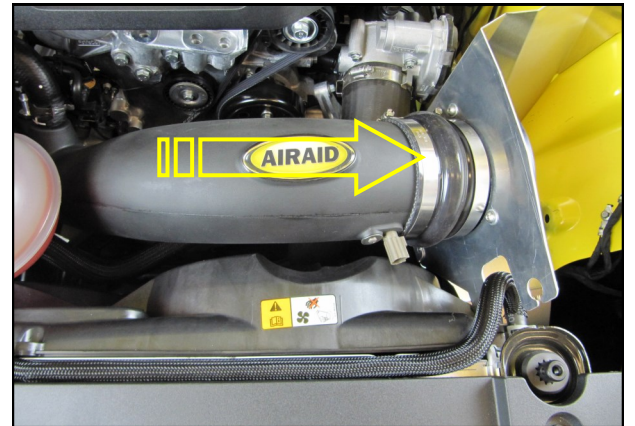

7. Slide the Airaid Intake Tube into the Hump Hose and tighten all four Hose Clamps.

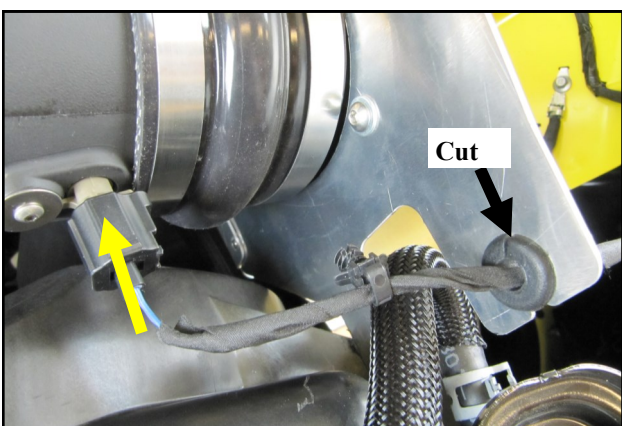

10. Split one edge of the remaining Grommet with a sharp knife and run the AT harness through it. Install the Grommet and harness into the Panel as shown and reconnect the sensor.



11. Install the Airaid Premium Filter onto the Filter Adapter. Install the weatherstrip on top of the Panel assembly as shown with the contour rolling away from the filter.



7. **Double check your work.** Make sure all clamps, hoses, bolts, and screws are tight. Double check the hood clearance. Reconnect the negative battery cable.

For your Oiled media filter we suggest using the AIRAID Filter Tune-Up Kit!

Thank you for purchasing the Airaid Intake System. Contact Airaid @ (800) 498-6951 8:00 AM - 5:00 PM MST weekdays for questions regarding fit or instructions that are not clear to you. Your Airaid Intake System was carefully inspected and packaged. Check that no parts are missing, or were damaged during shipping. If any parts are missing, contact Airaid. The air filter element is protected from direct exposure to water and debris; care should be taken not to drive through deep water. WATER INGESTION IS THE DRIVERS RESPONSIBILITY! The air filter is reusable and should be cleaned periodically.