



## Installation Instructions

For Part Numbers:

450-177	700-466 Airaid Oiled Media Filter
451-177	701-466 SynthaMax Dry Media Filter - Red
452-177	702-466 SynthaMax Dry Media Filter - Black
453-177	703-466 SynthaMax Dry Media Filter - Blue

2005-09 Ford Mustang  
4.0L V6

### Component Identification

1.	Airaid Premium Filter	1
2.	Airaid Intake Tube	1
3.	3 1/2"to3"x2 1/2" Reducer	1
4.	Urethane Hump Hose	1
5.	Filter Adapter	1
6.	Cool Air Dam	1
7.	Weather Strip 22"	1
8.	1/4-20 Button Head Bolt	3
9.	1/4" Flat Washer	5
10.	8-32 x 3/8" Button Head Bolt	2
11.	#48 Hose Clamp	1
12.	#52 Hose Clamp	1
13.	#72 Hose Clamp	2
14.	1/4-20 x 7/8" Hex Bolt	1
15.	1/4" Nylock Nut	1
16.	Grommet	1
17.	Aluminum Spacer	1
18.	1/4" Fender Washer	1
19.	#20 Torx Bit	1

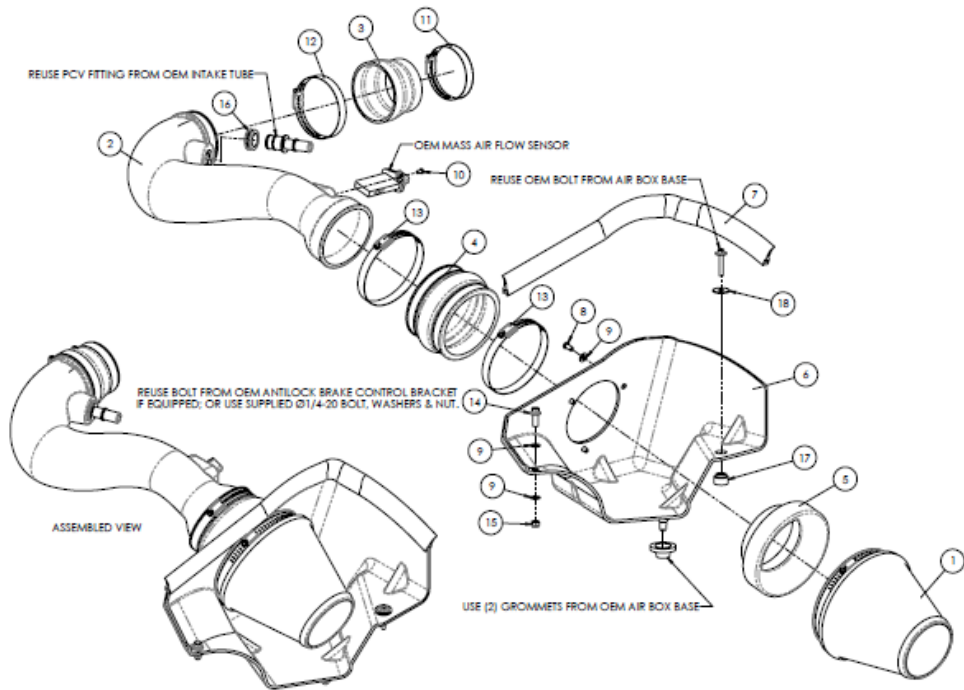

Full color instructions can be viewed on our web site at [Airaid.com](http://Airaid.com). Use the **Product Search** function to find your part number, and click **View Details**.



1. **Disconnect negative battery cable.**  
A) Loosen hose clamp on throttle body.  
B) Push green tab, and disconnect breather hose at the factory intake tube.  
C) Slide red tab, and disconnect the Mass Air Flow sensor wiring harness.

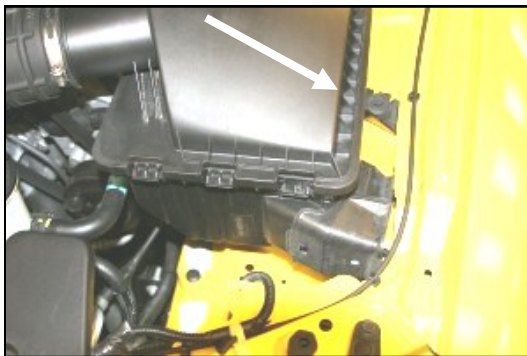

2. Remove bolt that holds the factory airbox to the fender. (Save bolt for later use in step #7).



3. Remove the complete intake system as an assembly.

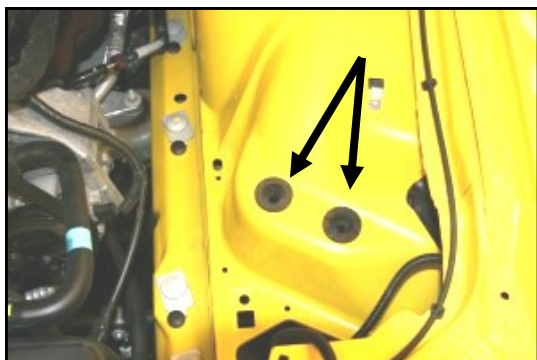

4. Make sure that you retain the factory grommets in the inner fender from the bottom of the factory airbox.



5. Using the supplied #20 torx bit, remove 2 factory screws, and remove the MAF sensor from the factory tube. (Save the MAF sensor for reinstallation in step #12).

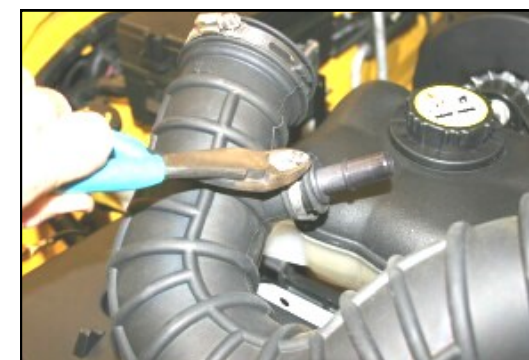

6. With a pair of side cutters, remove the metal band that holds the plastic breather fitting in the factory tube. Next remove the fitting from the tube, and save it for reinstallation in step #11.

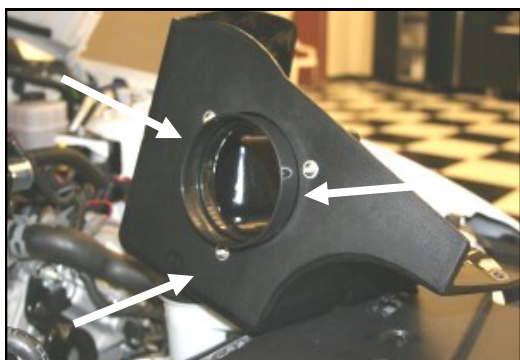

7. Install the air filter adapter (#5) into the Cool Air Dam (#6) as shown, using 3 button head bolts (#8) and 1/4" flat washers (#9).



8. Slide the Aluminum Spacer (#17) underneath the CAD and into the hole as shown. Secure the CAD to the inner fender using the OEM bolt from step # 2 and the supplied 1/4" Fender Washer (#18).

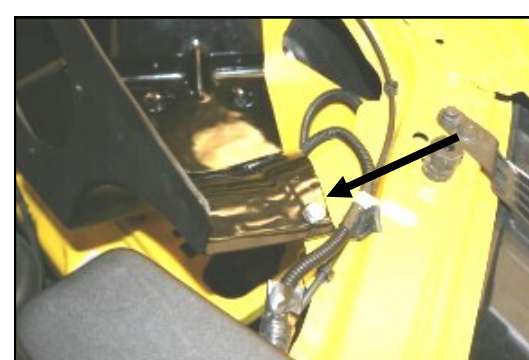

9. If your vehicle has the optional anti-lock brakes, remove the bolt from the bracket under the CAD, and reinstall it thru the hole in the front of the CAD. (See arrow). If your vehicle does not have this bracket, install the supplied 1/4" bolt (#14), two 1/4" washers (#9), and 1/4" Nylock nut (#15) thru the CAD and sheet metal, and tighten.



10. Install the supplied grommet (#16), into the Airaid Intake Tube (#2)

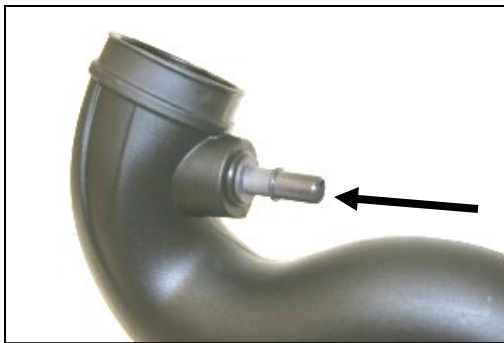

11. Install the factory fitting from step #7 into the grommet (#16) from step #10.



12. Install the MAF sensor from step #5 into the Airaid Intake Tube. Use the two supplied 8-32 button head bolts (#10), to securely fasten the MAF sensor.  
**Do Not Use The Factory Screws!**



13. Install the urethane hump hose (#4) on the filter adapter (#5) with two #72 hose clamps (#13). Next install the reducing coupler (#3) small end first, onto the throttle body with one #48 hose clamp (#11), and one #52 hose clamp (#12). Leave clamps loose.



14. Install the Airaid Intake Tube into the hump hose first, and then into the reducing coupler, adjust for fit, and then tighten the four hose clamps. Reconnect the breather hose, and the wiring harness to the MAF sensor.



15. Install the Airaid Premium Filter (#1) onto the filter adapter (#5). Next install the weather strip (#7) on the top of the CAD as shown. Start at the front of the CAD and work towards the rear.

### 16. Double check your work!

Make sure there is no foreign material in the intake path. Make sure all clamps, hoses, bolts, and screws are tight. Double check the hood clearance.

### 17. Reconnect the negative battery cable!

Thank you for purchasing the Airaid Intake System. Contact Airaid @ (800) 498-6951 8:00 AM - 5:00 PM MST weekdays for questions regarding fit or instructions that are not clear to you. Your Airaid Intake System was carefully inspected and packaged. Check that no parts are missing, or were damaged during shipping. If any parts are missing, contact Airaid. The air filter element is protected from direct exposure to water and debris; care should be taken not to drive through deep water. WATER INGESTION IS THE DRIVERS RESPONSIBILITY! The air filter is reusable and should be cleaned periodically.

## FILTER IDENTIFICATION

700-466 Airaid Oiled Media  
702-466 Airaid SynthaMax Dry Media - Black

701-466 Airaid SynthaMax Dry Media - Red  
703-466 Airaid SynthaMax Dry Media - Blue

**For your Oiled media filter we suggest using the AIRAID Filter Tune-Up Kit!**



P/N 790-551 Aerosol Spray  
P/N 790-550 Squeeze Spray



**SynthaMax**

**Do Not Oil**

Synthamax Air Filters do not require oil. Service air filter as needed by cleaning with common non-petroleum all-purpose household cleaner and water. Simple Green®, Formula 409® or equivalent works great. Apply cleaner to outside of air filter and allow to soak. Then flush filter clean from the inside out with a garden hose and repeat steps if necessary. Do not apply high pressure water or air to clean filter. Allow filter to air dry and reinstall.