



## Installation Instructions

For Part Numbers:

- 450-264C 700-461 Airaid Oiled Media Filter
- 451-264C 701-461 SynthaMax Dry Media Filter - Red
- 452-264C 702-461 SynthaMax Dry Media Filter - Black
- 453-264C 703-461 SynthaMax Dry Media Filter - Blue
- 450-964 Airaid Carbon Fiber Replacement Tube

2011-14 Ford Mustang GT  
5.0L V8

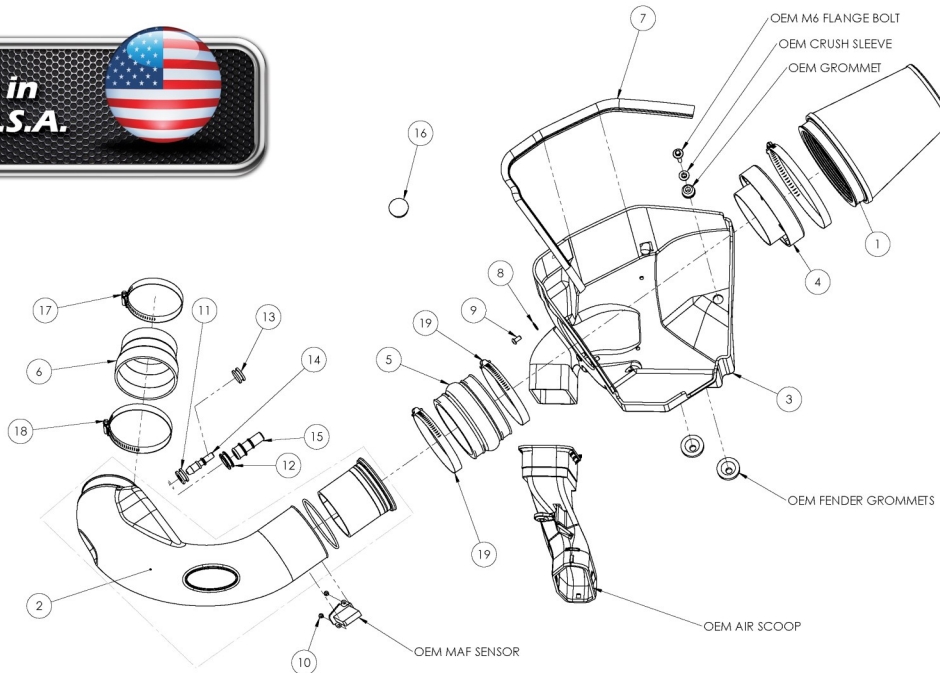

## Component Identification

1.	Airaid Premium Filter	1
2.	Airaid Intake Tube Assembly	1
3.	Cool Air Box	1
4.	Filter Adapter	1
5.	Silicone Hump Hose	1
6.	Silicone Coupler	1
7.	Weather Strip 25"	1
8.	1/4" Flat Washer	x3
9.	1/4-20 x 1/2" Button Head Cap Screw	x3
10.	8-32 x 3/8" Button Head Cap Screw	x2
11.	3/8" Grommet	x1
12.	5/8" Grommet	x1
13.	Blind Grommet	x1
14.	3/8 Aluminum Fitting	x1
15.	5/8" Aluminum Fitting	x1
16.	Firewall Plug	x1
17.	#56 Hose Clamp	x1
18.	#64 Hose Clamp	x3
19.	T-20 Torx Bit	x1

Full color instructions can be viewed on our web site at [Airaid.com](http://Airaid.com). Use the **Product Search** function to find your part number, and click **View Details**.



### Disconnect The Negative Battery Terminal!

1. If so equipped, remove the strut tower brace, then remove the engine cover by simply lifting it up, and set aside.

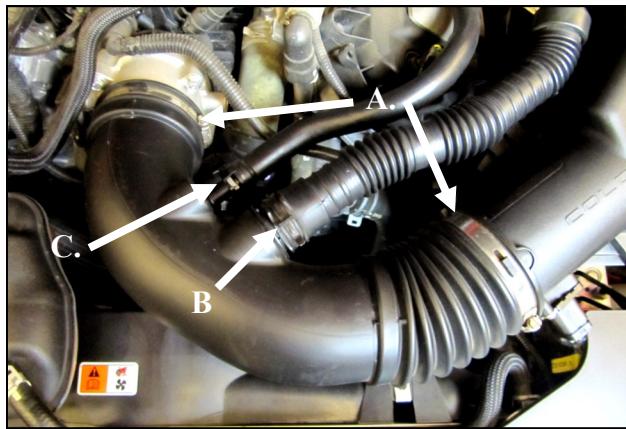

2. **A)** Loosen the hose clamps on the factory intake tube **B)** Squeeze the spring clamp and disconnect the resonator from the air intake tube. **C)** Carefully depress the hose lock tab, and disconnect the crank case breather line and the brake aspirator line if equipped, (AT models only). **D)** Remove the factory intake tube.

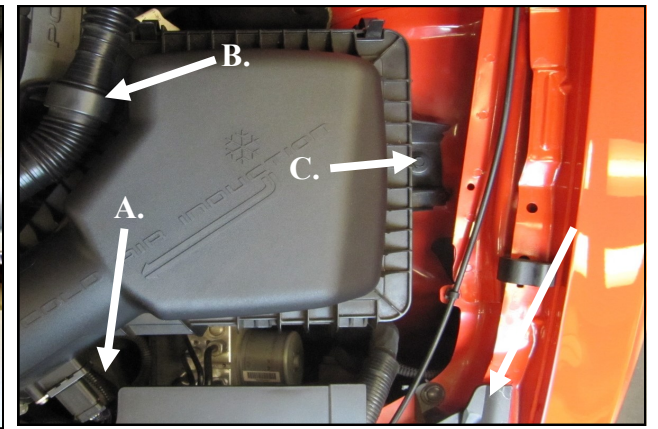

3. **A)** Disconnect the wiring harness from the Mass Air Flow sensor (MAF). Carefully pry the harness anchor from the air box using a screwdriver. **B)** Separate the resonator tube from the Air box lid. **C)** Using a 10mm socket, remove the bolt securing the air box to the inner fender and remove the air box assembly. This bolt will be reused in step 10.

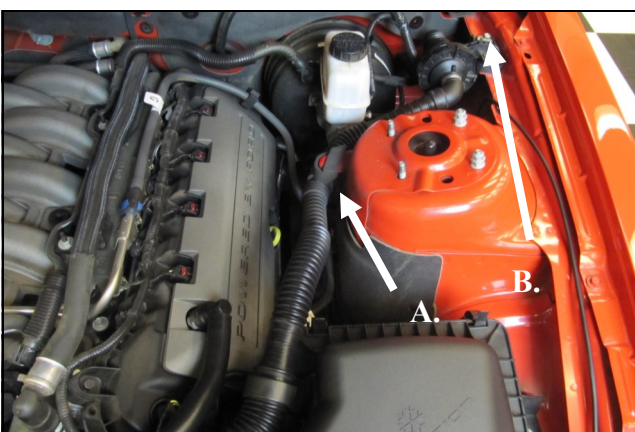

4. Remove the resonator assembly from the vehicle. **A)** Slide the hanger off of the strut tower tab. **B)** Remove the 6mm bolt securing the diaphragm body to the inner fender. Slide the resonator tubing out of the firewall and set the assembly aside. It will not be reused.



5. Insert the Fire Wall Plug (#16) into the resonator hole.



6. Using the supplied Torx bit, (#19) remove the MAF sensor from the factory airbox and transfer it into the Airaid Tube assembly (#2). Install the MAF sensor using two provided 8-32x3/8" screws (#10).

### Do Not Use The Factory Screws!

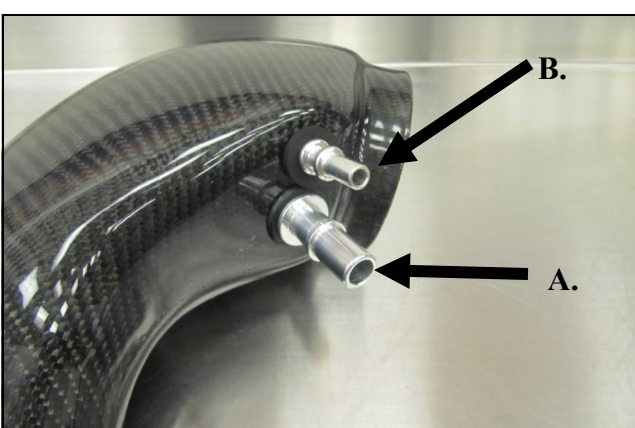

7. Install the Grommets and Fittings into the Airaid Intake Tube (#2): **A)** All models will require the use of the 5/8" Fitting (#15) and the 5/8" Grommet (#12). **B)** Automatic transmission equipped vehicles will also use the 3/8" Fitting (#14) and 3/8" Grommet (#11). Manual transmission vehicles will not need the 3/8" components and will use the Blind Grommet (#13)

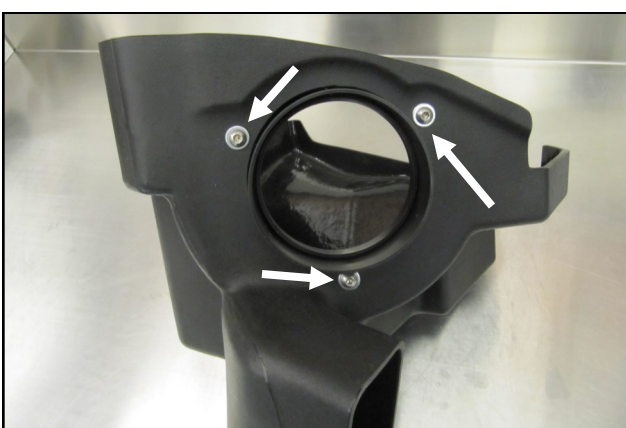

8. Install the filter adapter (#4) using three 1/4-20 button head bolts (#9), and Fat Washers (#8) into the Airaid Cool Air Box (CAB) (#3) as shown.

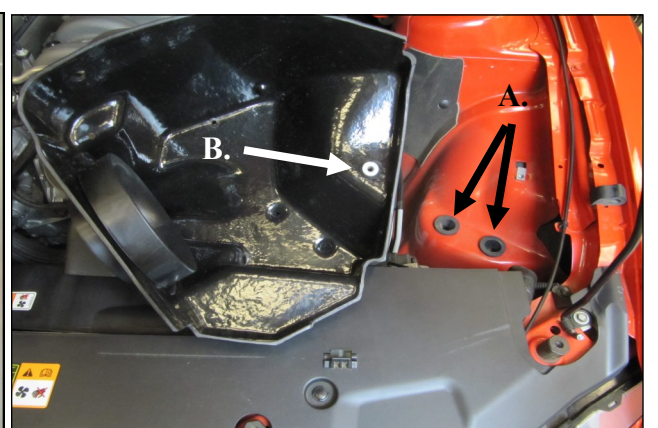

9. Transfer the factory air box mounting grommets. **A)** Locate and remove the Two Lower air box mounting grommets, and install them in the inner fender. **B)** Remove the Upper air box mounting grommet and steel sleeve, and re-install into the Airaid CAB.

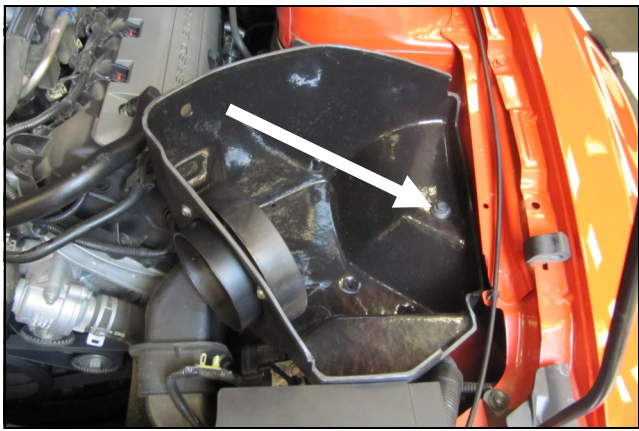

**10.** Install the CAB into the vehicle. Make sure that the Air inlet of the CAB aligns with the factory duct, and the two locating pins on the bottom align with the factory grommets. Next reinstall the factory bolt that was removed in step #3 through the steel sleeve and grommet and into the inner fender.

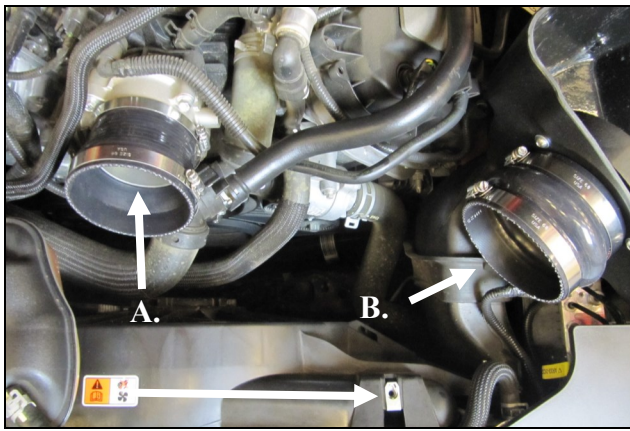

**11.** Install the Coupler and Hump Hose and Clamps:  
**A.** Install the Silicone Coupler (#6) and Hose clamps onto the throttle body. Place the #56 clamp (#15) on the Throttle body side of the reducer, and the #64 clamp (#18) on the open end. **B.** Install the Hump Hose (#5) onto the Filter Adapter along with two #64 hose clamps as shown. Leave the Clamps loose for now. Remove the Speed nut from the fan shroud.

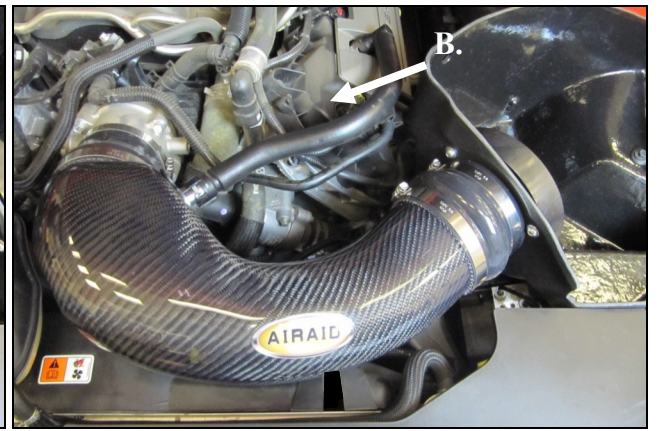

**12.** Install the Airaid Intake Tube into the couplers as shown, and tighten all Hose clamps. Reconnect the breather line/lines to the Aluminum Fittings depending on your application. Reconnect the Mass Air Flow sensor, which is now located in the lower back side of the intake. Slide the locking tab back into the connector

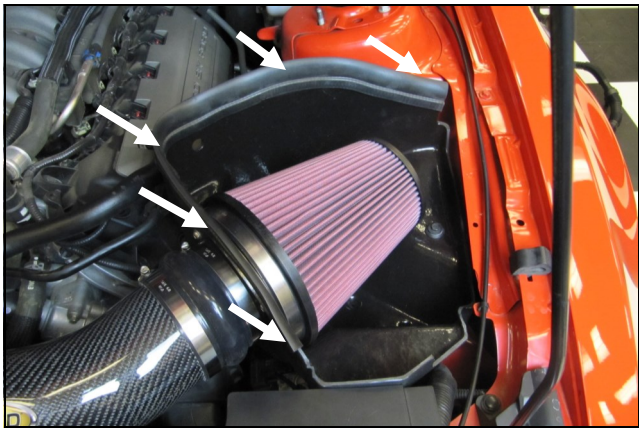

**13.** Install the Airaid Premium Filter (#1) onto the Filter Adapter and tighten the hose clamp. Install the Weather Strip (#7) onto the CAB with the contoured edge going away from the filter. Start at the front of the vehicle and work your way back.



**14.** Replace the engine cover and shock tower brace.

### 15. Double check your work!

Make sure there is no foreign material in the intake path. Make sure all clamps, hoses, bolts, and screws are tight. Double check the hood clearance. **It is Very important to verify that the Intake Tube is not rubbing on the fan shroud or the hood.**

**Reconnect the negative battery cable.**

**INSTALL NOTE:** If you are installing this kit on a vehicle equipped with a Power Dome Hood with Heat Extractors we suggest the use of our optional AIRAID pre-filter (Part #799-469) to give an added layer of protection from the elements.

Thank you for purchasing the Airaid Intake System. Contact Airaid @ (800) 498-6951 8:00 AM - 5:00 PM MST weekdays for questions regarding fit or instructions that are not clear to you. Your Airaid Intake System was carefully inspected and packaged. Check that no parts are missing, or were damaged during shipping. If any parts are missing, contact Airaid. The air filter element is protected from direct exposure to water and debris; care should be taken not to drive through deep water. **WATER INGESTION IS THE DRIVERS RESPONSIBILITY!** The air filter is reusable and should be cleaned periodically.

## FILTER IDENTIFICATION

700-461 Airaid Oiled Media  
 702-461 Airaid SynthaMax Dry Media - Black

701-461 Airaid SynthaMax Dry Media - Red  
 703-461 Airaid SynthaMax Dry Media - Blue

**For your Oiled media filter we suggest using the AIRAID Filter Tune-Up Kit!**

*SynthaMax*

**Do Not Oil**



Synthamax Air Filters do not require oil. Service air filter as needed by cleaning with common non-petroleum all-purpose household cleaner and water. Simple Green®, Formula 409® or equivalent works great. Apply cleaner to outside of air filter and allow to soak. Then flush filter clean from the inside out with a garden hose and repeat steps if necessary. Do not apply high pressure water or air to clean filter. Allow filter to air dry and reinstall.

P/N 790-551 Aerosol Spray  
 P/N 790-550 Squeeze Spray