



Installation Instructions

For Part Numbers:

450-328 700-495 Airaid Oiled Media Filter

451-328 701-495 SynthaMax Dry Media Filter - Red

452-328 702-495 SynthaMax Dry Media Filter - Black

453-328 703-495 SynthaMax Dry Media Filter - Blue

2015 Ford Mustang

5.0L GT V8



No Hassle
Warranty

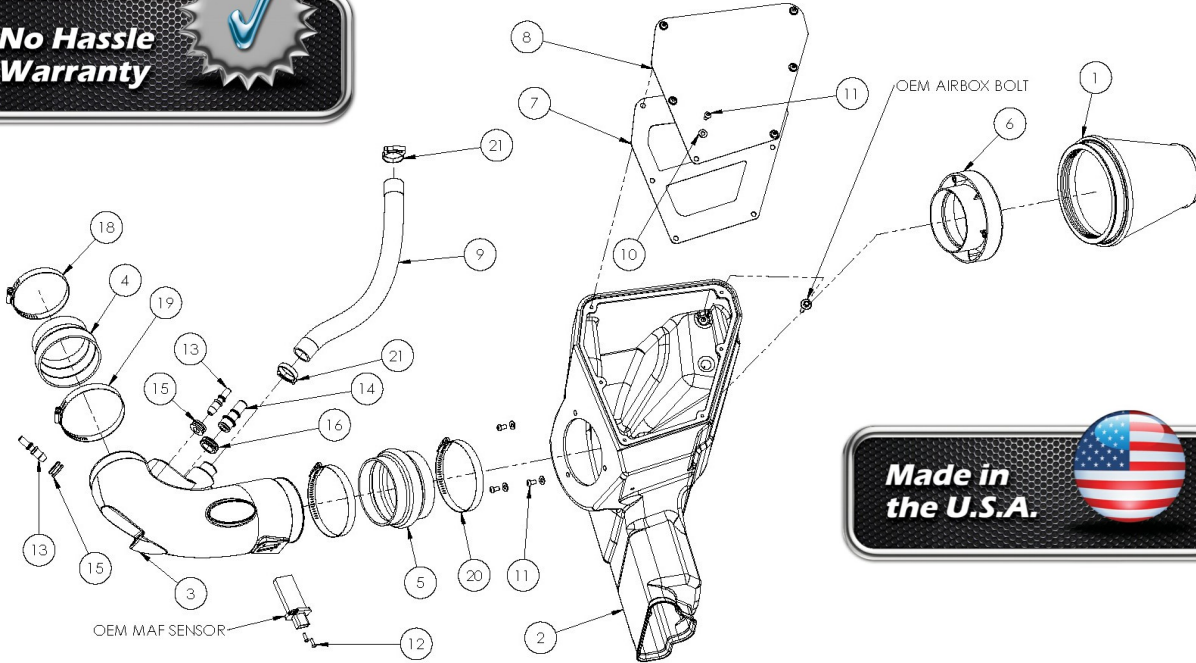

Component Identification

1	Airaid Premium Filter	1
2	Cold Air Box	1
3	Airaid Intake Tube	1
4	Reducing Coupler	1
5	Hump Hose	1
6	Filter Adapter	1
7	Air Box Lid	1
8	Air Box Window	1
9	1" Hose	1
	Hardware and Instructions	1
10	1/4" Flat Washer	9
11	1/4"-20 x 1/2" Button Head Screw	9
12	Button Head Screw	2
13	Aluminum Fitting	2
14	5/8 Aluminum Fitting	1
15	1/2" Grommet	2
16	3/16" Grommet	1
17	Resonator Cap, (Not Shown)	1
18	#56 Hose Clamp	1
19	#64 Hose Clamp	1
20	#68 Hose Clamp	2
21	Speed Clamp	2
22	Firewall Plug, (Not Shown)	1

Full color instructions can be viewed on our web site at Airaid.com. Use the **Product Search** function to find your part number, and click **View Details**.

FILTER IDENTIFICATION

700-495 Airaid Oiled Media
702-495 Airaid SynthaMax Dry Media - Black

701-495 Airaid SynthaMax Dry Media - Red
703-495 Airaid SynthaMax Dry Media - Blue



1. Remove the battery box cover in the cowl and disconnect the negative battery terminal.

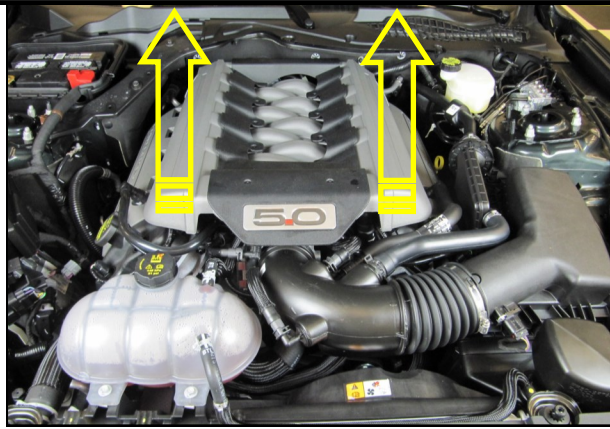

2. Remove the strut tower brace is so equipped. Lift up on the engine cover to unseat it from it's mounting grommets and set it aside.

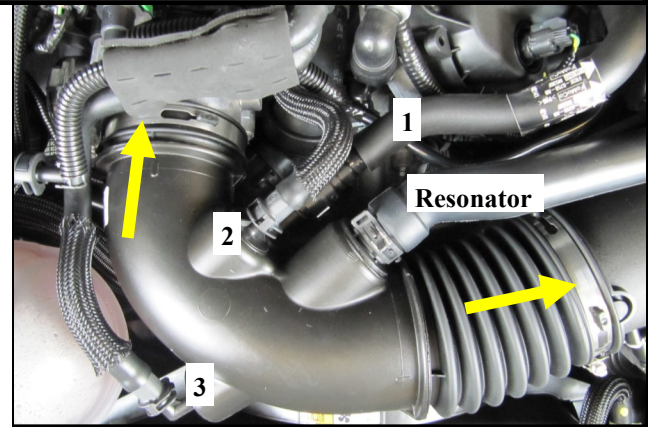

3. Disconnect the 3 breather lines and resonator tube from the intake tube. Loosen the hose clamps and remove the factory intake tube.

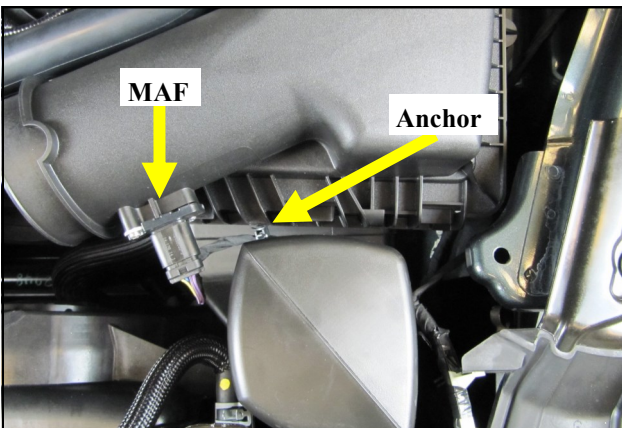

4. Gently pry the harness anchor out of the airbox and disconnect the mass air flow meter.

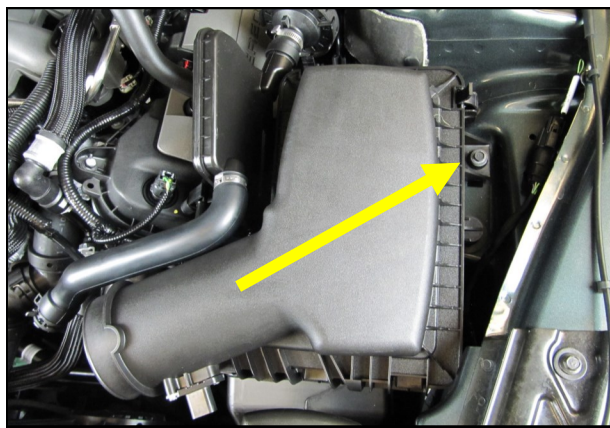

5. Remove the 6mm airbox mounting bolt in the inner fender and lift the entire airbox assembly out of the vehicle. Set the bolt aside for now. It is to be reused.

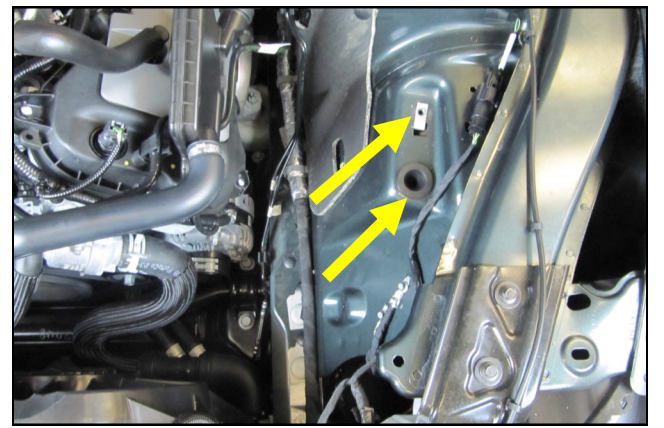

6. Be sure the speed clip and the airbox grommet remain inside the vehicle. They will be reused.



7. Install the Filter Adapter onto the Cold Air Box as shown, using the three 1/4-20 Button Head Screws and 1/4" Flat Washers

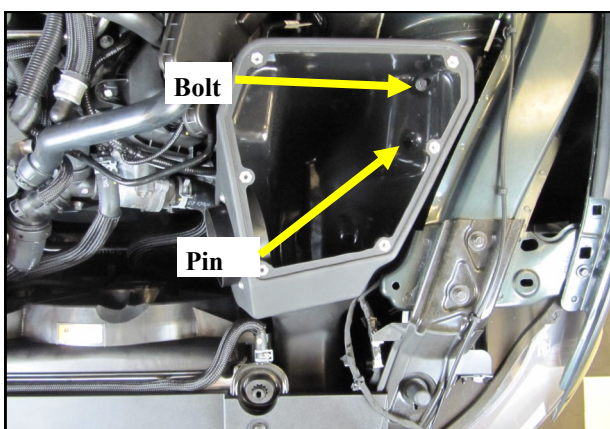

8. Place the Airaid Airbox assembly into the engine compartment as shown, with the locator pin on the bottom of the box inside the fender grommet. Secure the Airbox by reusing the 6mm bolt removed in step # 5.

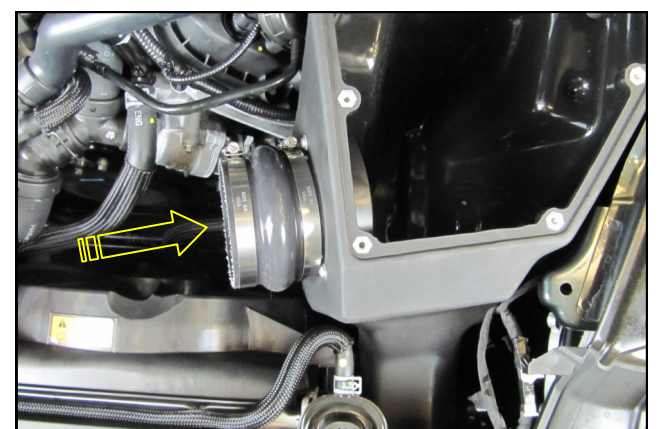

9. Slide the Hump Hose and Clamps onto the Filter Adapter as shown. Do not tighten the clamps at this time.

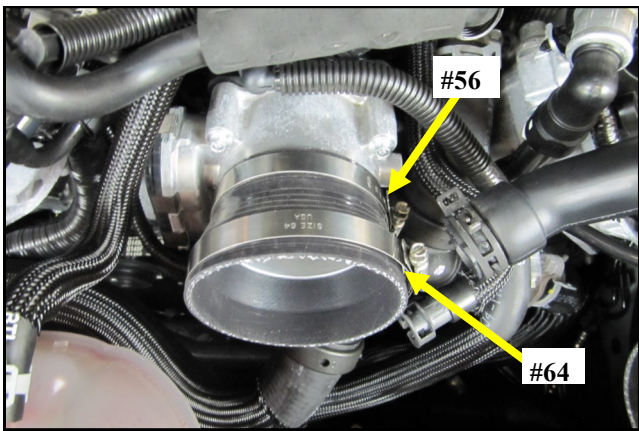

10. Slide the Reducer and Clamps onto the throttle body as shown.

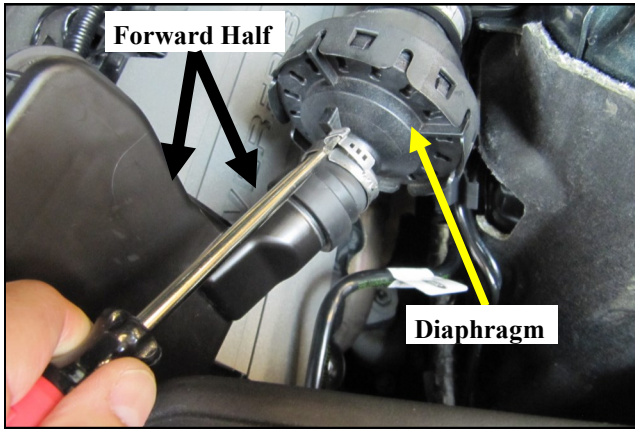

11. Using a standard screwdriver, carefully pry open the clamp on the resonator diaphragm and remove the forward half of the resonator.

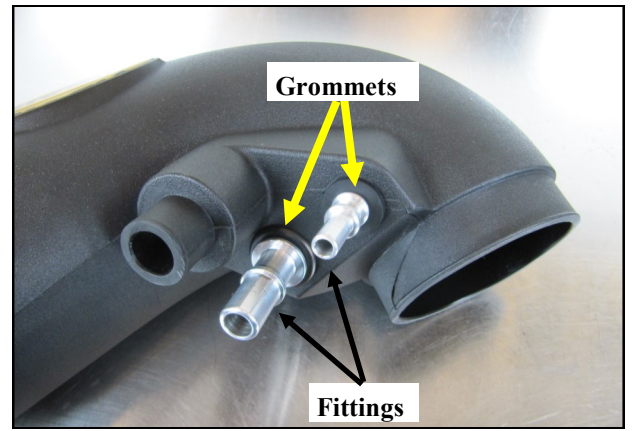

12. Insert the Grommets and Aluminum Fittings into the Airaid Intake tube as shown.

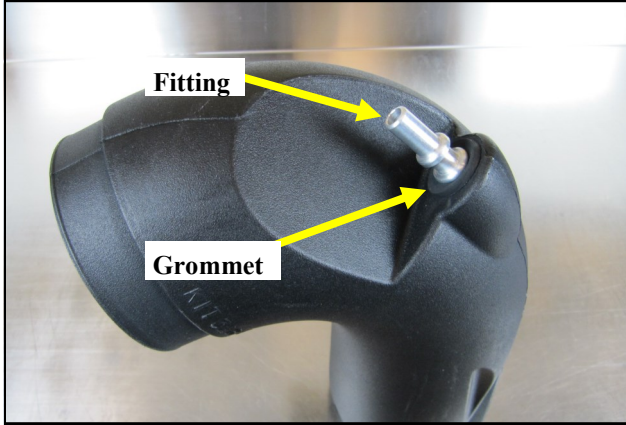

13. Insert the remaining Grommet and Fitting into the Intake tube as shown.

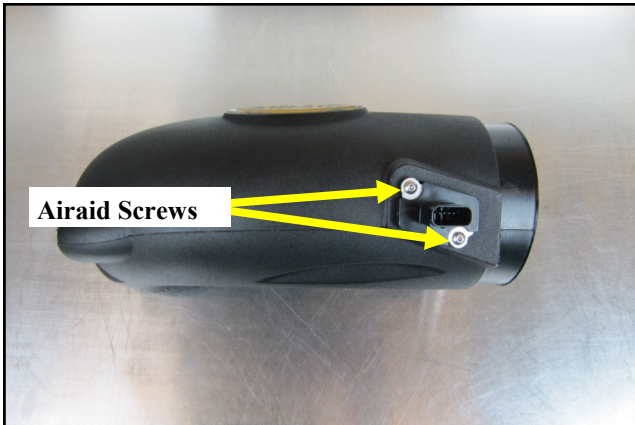

14. Insert the Mass Airflow sensor into the Airaid intake tube as shown and secure it using the #8 Button Head Screws. Do Not Use the OEM hardware.



15. Insert the Intake Tube into the Hump Hose and Reducer then tighten all 4 Intake Clamps.

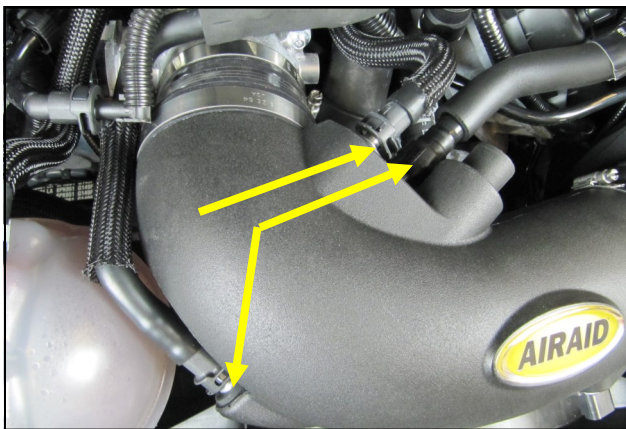

16. Reconnect the breather hoses to the Fittings in the Airaid Intake Tube.



17. Connect the resonator to the Intake Tube as shown using the supplied 1" Hose and the Speed clamps on both ends.

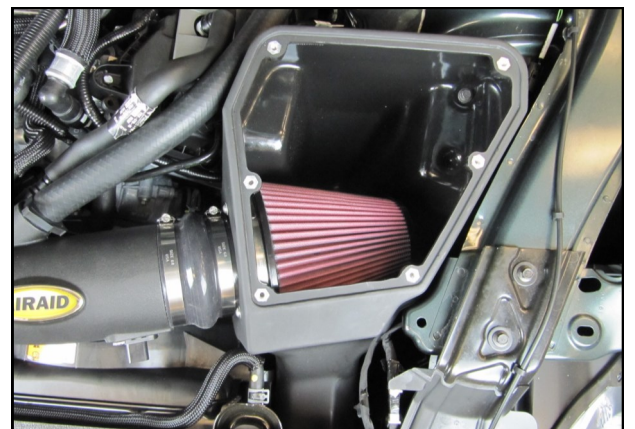

18. Install the Airaid Premium Filter onto the Filter Adapter inside of the Airbox.

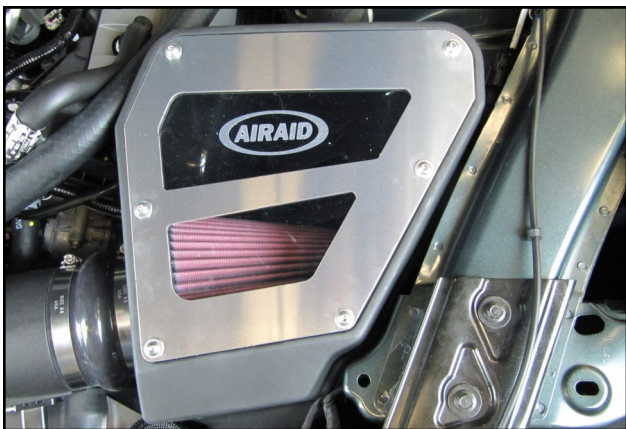

19. Remove the protective film from the Lid and Window before installation. Install the Airbox lid and Window onto the Airbox, with the Window on top, using 6 sets of 1/4" Button Heads, and Washers.

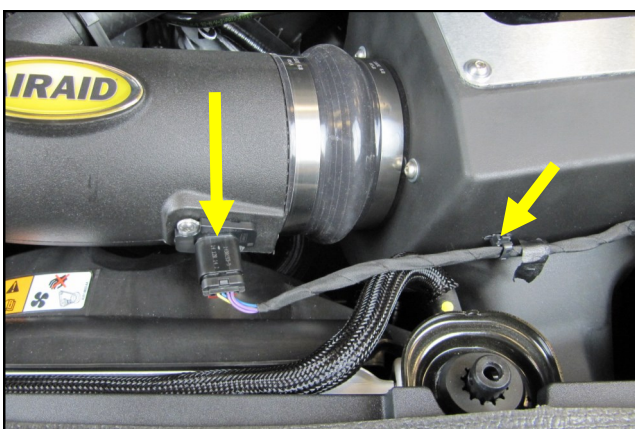

20. Reconnect air flow meter and plug the wire harness anchor into the Airbox wall.



21. Double check your work. Make sure all clamps, hoses, bolts, and screws are tight. Double check the hood clearance. Reconnect the negative battery cable and reinstall the cover.

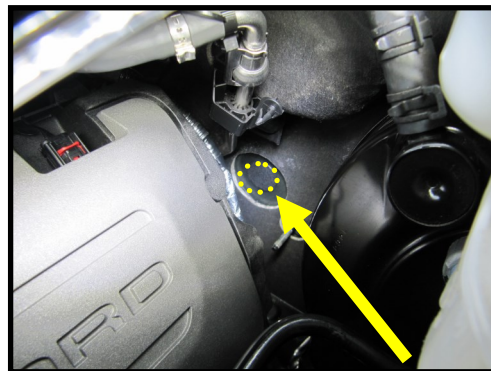

Resonator Delete Option: The resonator can be safely deleted if so desired by capping off the Intake Tube with the supplied Cap and Speed clamp. After removing the resonator assembly from the firewall, insert the included Firewall plug to prevent debris from entering the cabin.



For your Oiled media filter we suggest using the AIRAID Filter Tune-Up Kit!

SynthaMax

Synthamax Air Filters do not require oil. Service air filter as needed by cleaning with common non-petroleum all-purpose household cleaner and water. Simple Green®, Formula 409® or equivalent works great. Apply cleaner to outside of air filter and allow to soak. Then flush filter clean from the inside out with a garden hose and repeat steps if necessary. Do not apply high pressure water or air to clean filter. Allow filter to air dry and reinstall.

Thank you for purchasing the Airaid Intake System. Contact Airaid @ (800) 498-6951 8:00 AM - 5:00 PM MST weekdays for questions regarding fit or instructions that are not clear to you. Your Airaid Intake System was carefully inspected and packaged. Check that no parts are missing, or were damaged during shipping. If any parts are missing, contact Airaid. The air filter element is protected from direct exposure to water and debris; care should be taken not to drive through deep water. WATER INGESTION IS THE DRIVERS RESPONSIBILITY! The air filter is reusable and should be cleaned periodically.