



Installation Instructions

For Part Numbers:

510-201	700-458 Airaid Oiled Media Filter
511-201	701-458 SynthaMax Dry Media Filter - Red
512-201	702-458 SynthaMax Dry Media Filter - Black
513-201	703-458 SynthaMax Dry Media Filter - Blue

2007-09 Toyota FJ Cruiser 4.0L V6
C.A.R.B. E.O. Includes 2007
Vehicles Only... All Others Pending

Component Identification

1.	Airaid Premium Filter	1
2.	MAF Panel	1
3.	Bottom Panel	1
4.	Silicone Hump Hose	1
5.	Left Gskt Support Frame	1
6.	Right Gskt Support Frame	1
7.	Weather Strip 21"	1
8.	#64 Hose Clamp	2
9.	6-32x5/16" Screw	6
10.	#6 Flat Washer	6
11.	6-32 Keps Nut	6
12.	M8x1.25x16mm Hex Bolt	3
13.	1/4-20x1/2" Button Head Bolt	1
14.	1/4" Flat Washer	1
15.	1/4" Serrated Nut	1
16.	5/16" Flat Washer	3
17.	Bracket	1
18.	3/16" Plastic Plug	2
19.	Small Rubber Washer	2

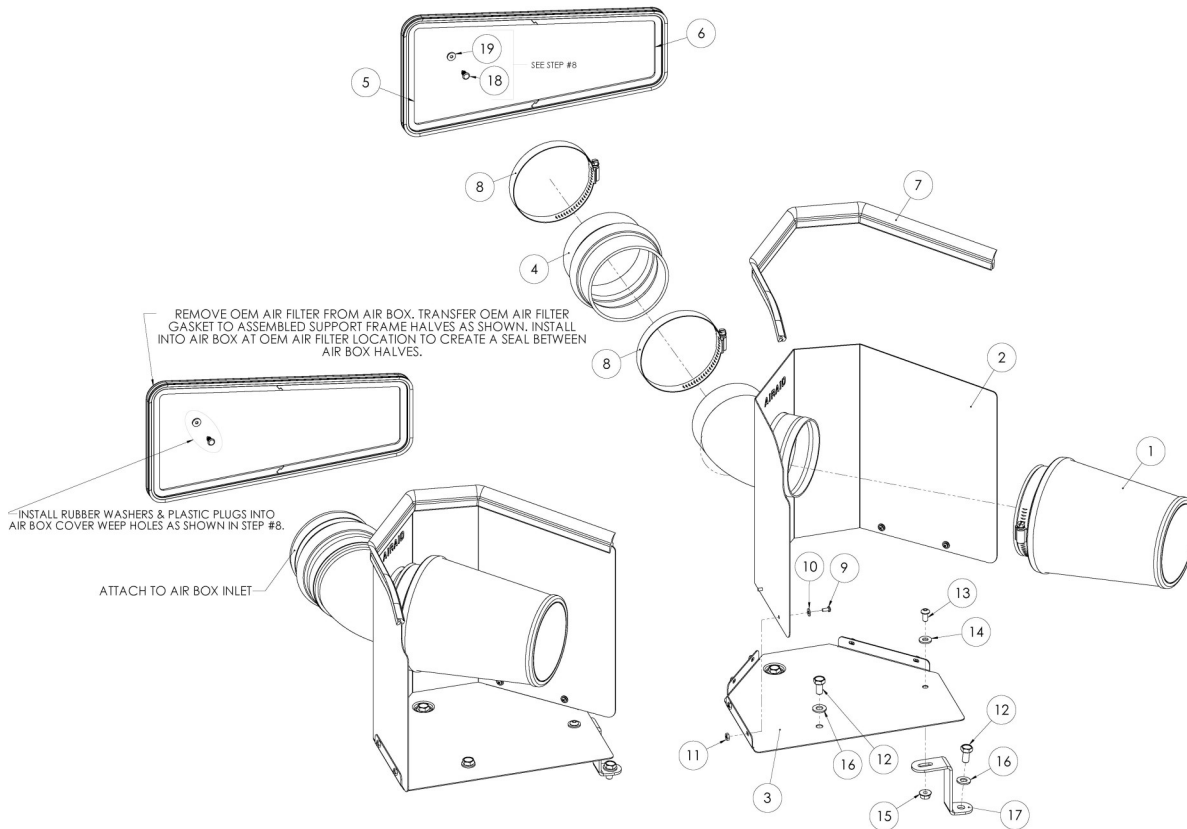

Full color instructions can be viewed on our web site at Airaid.com. Use the **Product Search** function to find your part number, and click **View Details**.

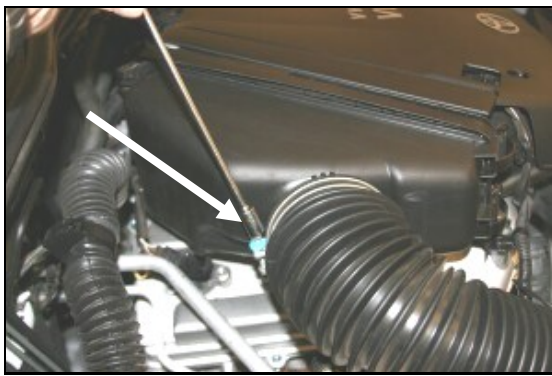

1. **Disconnect the negative battery cable.** Loosen the hose clamp on the factory intake tube where it connects to the airbox.

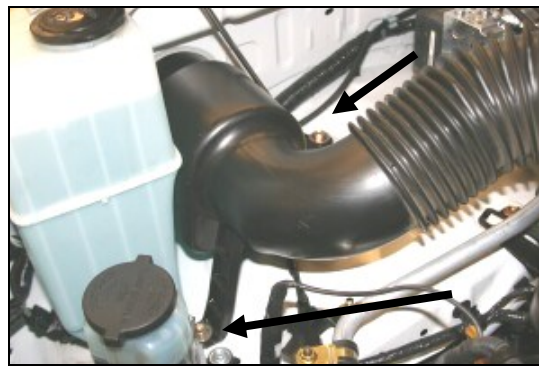

2. With a 12mm socket, remove two bolts that hold the intake tube to the fender.



3. Remove the complete intake tube from the vehicle.



4. Unlatch the two clips that hold the cover on the factory airbox and remove the cover and the factory air cleaner.



5. Remove the rubber gasket from around the factory air cleaner.

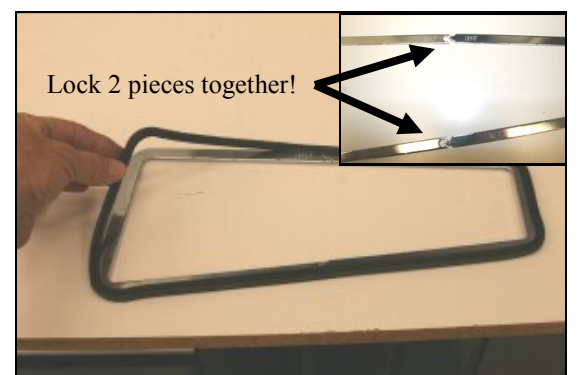

6. Lay the left and right gasket support frames (#5) & (#6) on a workbench (see inset) and re-install the factory rubber gasket around the outside as shown.

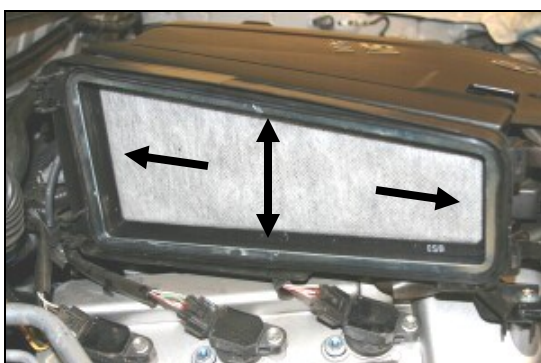

7. Re-install the gasket assembly back into the factory airbox as shown. Do not tamper with the factory hydrocarbon filter, as this will void the vehicle manufacturer's warranty, and street legal status in the state of California.



8. Install the two rubber washers (#19) onto the two plastic plugs (#18) that are provided in the hardware kit, and insert them into the two weep holes in the factory air cleaner cover removed in step #4, as shown

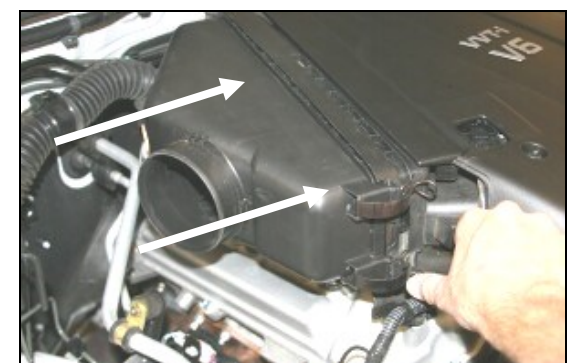

9. Re-install the factory airbox cover, and re-latch both clips.

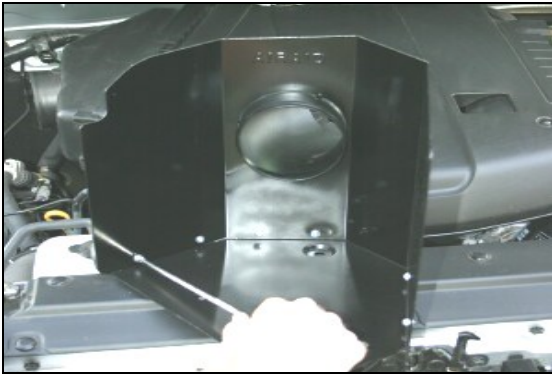

10. Assemble the Cool Air Dam panels (#2), and (#3) using the six supplied screws (#9), washers (#10), and nuts (#11), as shown.



11. Install the urethane hump hose (#4), and two #64 hose clamps (#8) on the tube of the CAD as close to the panel as possible. Leave the hose clamps loose for now.



12. Install the bracket (#17) on the front of the CAD using the 1/4-20 button head bolt (#13), 1/4" flat washer (#14), and 1/4" serrated nut (#15), as shown. Just snug the bolt for now, there will be some adjustment needed once the CAD has been installed.

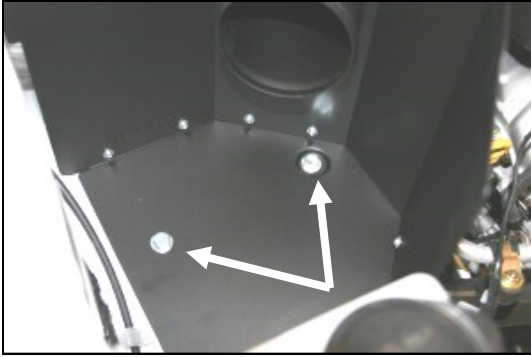

13. Install the CAD into the vehicle by aligning the hump hose with the tube on the factory airbox, and then aligning the two holes in the bottom of the CAD, and the bracket, with the three mounting holes on the inner fender. Install the three supplied 8mm bolts (#12) and washers (#15).



14. Center the hump hose between the tube on the factory airbox, and the tube on the CAD, adjust for fit, and tighten the hose clamps. Now tighten the button head bolt that holds the bracket to the CAD.



15. Install the Airaid Premium Filter (#1) on the CAD tube and tighten the clamp. Next install the weather strip (#7) on top of the CAD as shown. For an easier install, start at the fender side of the CAD and work your way towards the radiator.

16. Double check your work!

Make sure there is no foreign material in the intake path. Make sure all clamps, hoses, bolts, and screws are tight. Periodically check the tightness of all hose clamps. Double check the hood clearance.

17. Reconnect the negative battery cable!

Thank you for purchasing the Airaid Intake System. Contact Airaid @ (800) 498-6951 8:00 AM - 5:00 PM MST weekdays for questions regarding fit or instructions that are not clear to you. Your Airaid Intake System was carefully inspected and packaged. Check that no parts are missing, or were damaged during shipping. If any parts are missing, contact Airaid. The air filter element is protected from direct exposure to water and debris, care should be taken not to drive through deep water. WATER INGESTION IS THE DRIVERS RESPONSIBILITY! The air filter is reusable and should be cleaned periodically.

FILTER IDENTIFICATION

700-458 Airaid Oiled Media
702-458 Airaid SynthaMax Dry Media - Black

701-458 Airaid SynthaMax Dry Media - Red
703-458 Airaid SynthaMax Dry Media - Blue

For your Oiled media filter we suggest using the AIRAID Filter Tune-Up Kit!



P/N 790-551 Aerosol Spray
P/N 790-550 Squeeze Spray



SynthaMax

Do Not Oil

Synthamax Air Filters do not require oil. Service air filter as needed by cleaning with common non-petroleum all-purpose household cleaner and water. Simple Green®, Formula 409® or equivalent works great. Apply cleaner to outside of air filter and allow to soak. Then flush filter clean from the inside out with a garden hose and repeat steps if necessary. Do not apply high pressure water or air to clean filter. Allow filter to air dry and reinstall.