



## Installation Instructions

For Part Numbers:

860-042 Airaid Oiled Media Filter  
 861-042 SynthaMax Dry Media Filter - Red  
 862-042 SynthaMax Dry Media Filter - Black  
 863-042 SynthaMax Dry Media Filter - Blue

**Airaid Direct Fit Filter**  
**1997-04 Chevrolet Corvette**  
**5.7L V8 All Models**

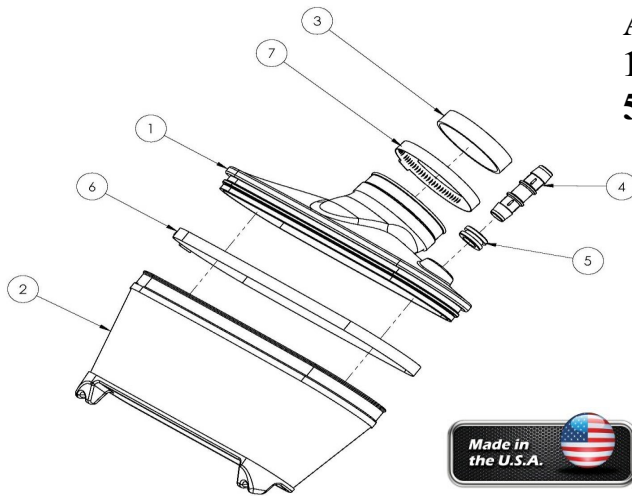

### Component Identification

1. Filter Base	1
2. Filter Media	1
3. MAF Shim	1
4. Barbed Fitting	1
5. Grommet	1
6. #196 Hose Clamp	1
7. #64 Hose Clamp	1

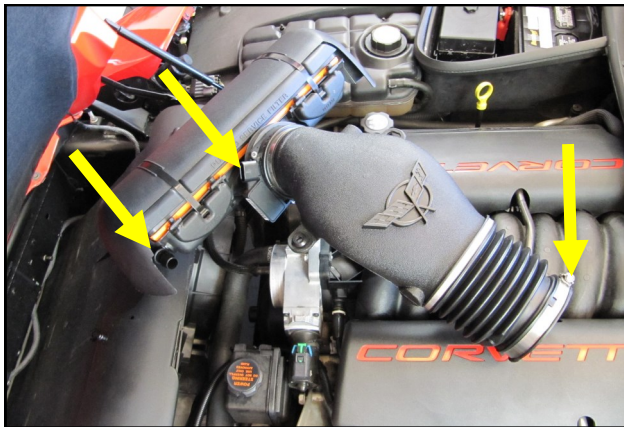

1. Disconnect the Mass Air Flow sensor, the air pump breather line and loosen the hose clamp on the throttle body. Remove the entire intake as an assembly and set it aside.

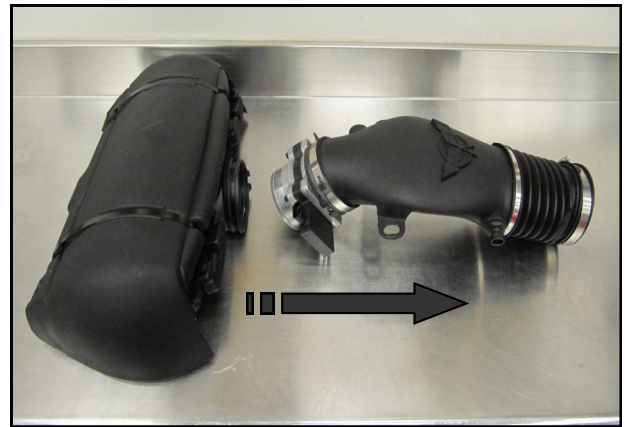

2. Separate the factory air box from the intake tube and Air Flow meter.

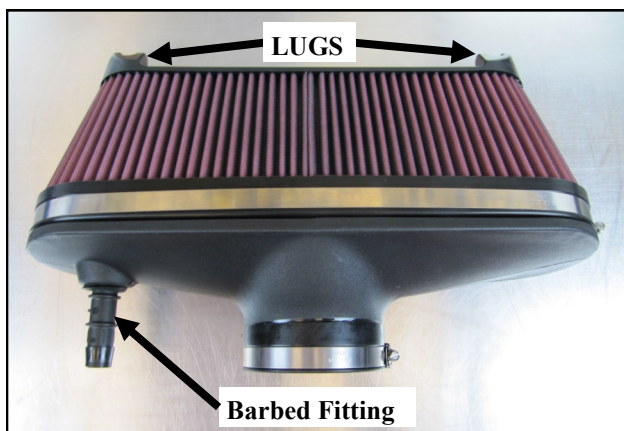

3. Create the Filter Assembly as shown using the supplied Grommet, Barbed Fitting and Hose Clamps. Refer to the Exploded Diagram for assembly detail. Note the location of the Filter location lugs and their position relative to the Barbed Fitting. Maximum Hose Clamp torque is to be no greater than 20 LB/IN.



4. On 1997-2000 models the MAF shim will need to be installed for proper fit.

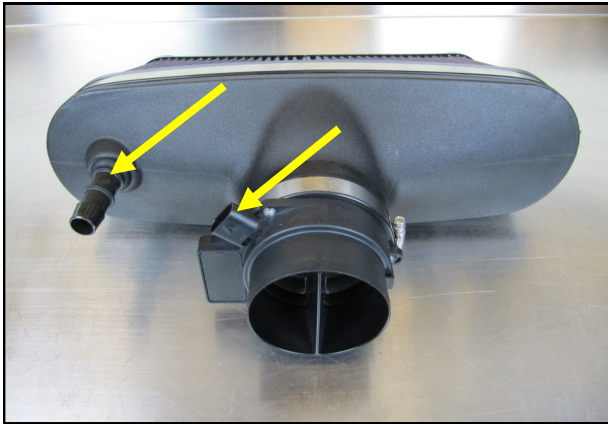

5. Transfer the Mass Air Flow meter into the Airaid Filter Assembly. Note the positioning of the air meter socket in relation to the breather coupling.

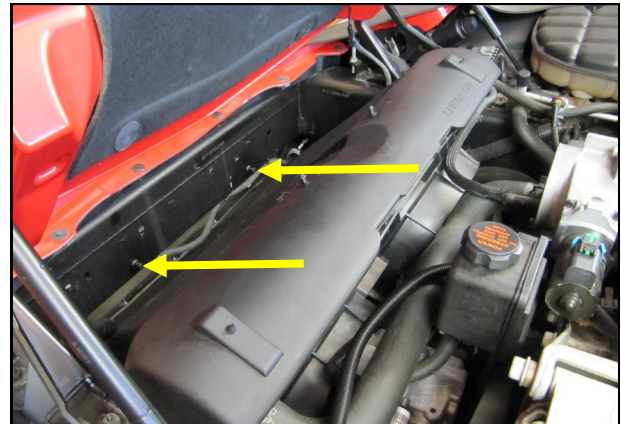

6. Inspect the inner bumper area and verify that none of the air box mounting grommets were retained during disassembly.



7. Reinstall the OEM intake tube onto the MAF and Filter Assembly then lower into the inner bumper area. When properly installed the Filter end cap will positively engage the grommet posts on the inner frame.

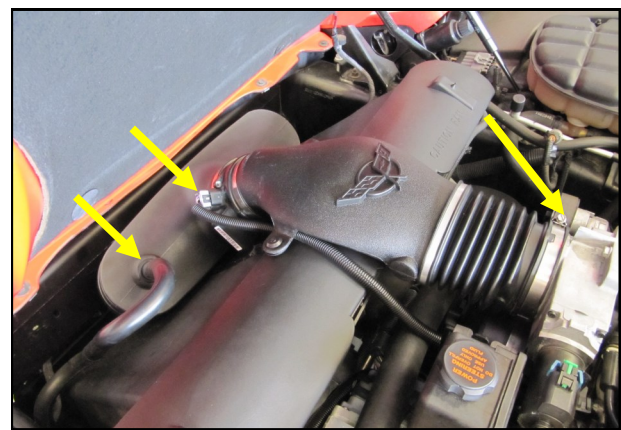

8. Re-secure the intake tube onto the throttle body and re seat the grommets on the radiator shroud posts. Re connect the MAF and air pump breather line.

For your Oiled media filter we suggest using the AIRAID Filter Tune-Up Kit!



P/N 790-551 Aerosol Spray  
P/N 790-550 Squeeze Spray

# SynthaMax®

## Do Not Oil

Synthamax Air Filters do not require oil. Service air filter as needed by cleaning with common non-petroleum all-purpose household cleaner and water. Simple Green®, Formula 409® or equivalent works great. Apply cleaner to outside of air filter and allow to soak. Then flush filter clean from the inside out with a garden hose and repeat steps if necessary. Do not apply high pressure water or air to clean filter. Allow filter to air dry and reinstall.