

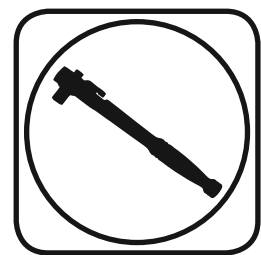

### Part # 11165010/11165110 - 1967-1967 GM F-Body StreetGrip

<b>Front Components</b>	
11169590	Delrin Control Arm Bushings
90000894	Tall Upper Balljoint
11162350/11162351	Front Dual Rate CoilSprings
22149846	Front HQ Series Shocks
11169120	Front SwayBar
<b>Rear Components</b>	
11164799	Composite Leaf Springs
11165399	Delrin Leaf Spring Bushings
22189842	Rear HQ Series Shocks

#### Recommended Tools



## 1967-1969 GM F-Body Street Grip Installation Instructions

<b>Table of contents</b>	
Page 2.....	Major components and Hardware List
Page 3.....	Getting Started
Page 4-6.....	Delrin Bushings
Page 7-8.....	Tall Upper Balljoint
Page 9.....	Front Dual Rate CoilSpring
Page 10-13.....	Front SwayBar
Page 14-19.....	Composite Leaf Springs & Delrin Bushings
Page 19-22.....	Front and Rear HQ Series Shocks

The majority of the StreetGrip components will be installed together. For example, the Front CoilSprings, Balljoint, Control Arm Bushings and Shocks will be installed in conjunction with each other. On the rear, the CoilSprings and Shocks will be installed in conjunction with each other. The front SwayBar will need to be attached to the frame **before** the rest of the components are installed.



### Major Components .....In the box

Part #	Description	QTY
55480700/55518800	Front CoilSprings- Small Block/Big Block	2
90002550	Rear Leaf Springs w/ Delrin Bushings & Inner Sleeves Installed	2
90002497	Leaf Spring Clamp Plate	4
90000894	Tall Upper Balljoint	2
90002514	Delrin Bushing Outer Shell - Upper Control Arm	4
90002515	Delrin Bushing Outer Shell - Lower Control Arm	2
90002516	Delrin Bushing Outer Shell - Lower Control Arm	2
70012395	Delrin Bushing - Upper Control Arm	4
70012397	Delrin Bushing - Lower Control Arm	2
70012396	Delrin Bushing - Lower Control Arm	2
	<b>Front &amp; Rear Shocks</b>	
22849999	4.75" Stroke Stud Top Shock - Front	2
70011139	5/8" ID Shock Bushing (Installed in Shock) - Front	2
90002069	Standard T-bar (Installed in Shock) - Front	2
70011140	Stud Top Bushing - Front & Rear	8
70011141	Stud Top Bushing Washer - Front & Rear	8
99372006	3/8"-24 Jam Nut - Front & Rear	8
22889999	7.55" Stroke Stud Top Shock - Rear	2
70011138	3/4" ID Shock Bushing (Installed in Shock) - Rear	2
90002103	5/8" ID Shock Sleeve (Installed in Shock)	2
90002102	1/2" ID Shock Sleeve	2
90001619	Cantilever Pin	2
90000471	Cantilever Pin Spacer	2
11169120	Front Swaybar Kit	1
90002496	Leaf Spring Shackle Plates	4
70012433	Frame Shackle Bushing	4
90000526	Frame Shackle Inner Bushing Sleeve	2
99501006	1/2"-13 x 3 1/2" Hex Bolt - Lower Control Arm	4
99501035	1/2"-13 x 5" Hex Bolt - Leaf Spring Bushings	6
99502009	1/2"-13 Nylok Nut - Lower Control Arm & Leaf Spring Bushings	10



## Installation Instructions



### Getting Started.....

Congratulations on your purchase of the Ridetech StreetGrip Kit. This system has been designed to give your Car excellent ride and handling along with a lifetime of enjoyment. Some of the key features of this Kit: Dual Rate CoilSprings, Composite Leaf Springs, Delrin Control Arm & Leaf Spring Bushings, Larger Swaybar with Delrin Liners and a Taller Upper Balljoint.

The majority of the StreetGrip Components will be installed together. For example, the Front CoilSprings, Balljoint, Control Arm Bushings and Shocks will be installed in conjunction with each other. On the rear, the Leaf Springs, Delrin Bushings and Shocks will be installed in conjunction with each other. The front SwayBar will need to be ATTACHED to the frame BEFORE the rest of the front components are installed. The SwayBar installation will be finished after the rest of the front components are installed

### Front Suspension

The front components that will need to be installed are: Control Arm Bushings, Upper Ball Joints, Shocks, and CoilSprings. The SwayBar needs to be ATTACHED to the frame BEFORE the rest of the front components are installed.

If you have never done this type of work before, we recommend getting a Factory Service Manual for proper procedures of disassembly and reassembly of the components for your car.

### Rear Suspension

The rear components that will be installed are; rear Composite Leaf Springs, Delrin Leaf Spring Bushings, and rear HQ Series Shocks. The Composite Leaf Springs and Delrin Leaf Spring Bushings will be installed at the same time. The Delrin Leaf Spring Bushings are preinstalled in the Leaf Springs.



**Part # 11169590 - 1967-1969 F-Body Delrin Control Arm Bushings**



Recommended Tools

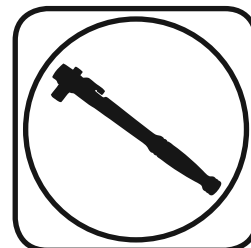

## 1967-1969 F-Body Delrin Control Arm Bushings Installation Instructions

Table of contents

Page 5..... Included components and Hardware List

Page 6..... Bushing Installation

**IF YOUR CAR HAS AN OVAL BUSHING IN THE LOWER CONTROL ARM, IT WILL BE NECESSARY TO PURCHASE CONTROL ARMS THAT UTILIZE 2 ROUND BUSHINGS.**



### Major Components .....In the box

Part #	Description	QTY
90002514	Upper Control Arm Bushing Outer Shell and Inner Sleeve	4
90002515	Lower Control Arm Bushing Outer Shell and Inner Sleeve - Small Lower	2
90002516	Lower Control Arm Bushing Outer Shell and Inner Sleeve - Large Lower	2
70012395	Delrin Upper Control Arm Bushing	4
70012397	Delrin Lower Control Arm Bushing - Small Lower	2
70012396	Delrin Lower Control Arm Bushing - Large Lower	2

Part #	Description	Usage	QTY
99501006	1/2" -13 x 3 1/2" Hex Bolt	Lower Control Arm to Frame	4
99502009	1/2" -13 Nylok Nut	Lower Control Arm to Frame	4
99373005	3/8" Split Lockwasher	Upper Control Arm Shaft Bolts	4

### Getting Started.....

The Front Control Arms will need to be removed from the car. Refer to the Factory Service Manual for disassembly procedure.

**This F-Body Bushing Kit contains: 4 Upper Control Arm Bushing Assemblies and 4 Lower Control Arm Bushing Assemblies. The Upper Bushings are all the same; there are 2 different diameter Lower Bushings with the larger diameter Bushing being the Rear Bushing. Be sure to match the correct Bushings with the correct locations.**

There are several different ways that the Bushings can be removed from the Control Arms. If you have an Air Chisel, a Wide Flat Bit works well. If you don't have access to an Air Chisel, they can be removed by first, Drilling out the rubber with a Hand Drill and Drill Bit. With the Rubber removed, distort the Bushing Shell with a Hammer and Chisel and Knock it out. No matter the process used, the main objective is to **NOT** distort the Control Arm.

**WE RECOMMEND MARKING DRIVER AND PASSENGER CONTROL ARMS AND CROSS SHAFTS. ALSO, MARK THE ORIENTATION OF THE CROSS SHAFTS.**

1. Measure the Outside Width of the Control Arms and write it down before starting Bushing Removal. You will use this Dimension to check the Control Arms after the new Delrin Bushings are installed.



### Delrin Bushing Installation

The Cross Shaft must be put in place before installing the Bushing Shells in the Upper Control Arm.

Just like Bushing Removal, there are several ways the Delrin Bushing Assemblies can be installed. No matter the method used, the Control Arm needs to be **SUPPORTED** to keep from distorting the Control Arm. We recommend cutting spacers to go inside the Control Arms when using a Press to install the Bushings. We have used several different methods to install the Bushing Assemblies, we are going to cover the one that worked best for us. When installing the Bushings, the Outer Shell will be installed in the Arm by itself. Next, Press in the Delrin Bushing, followed by the Inner Sleeve. **WE DO NOT RECOMMEND INSTALLING THE BUSHINGS COMPLETELY ASSEMBLED.**

**Note:** The Delrin is self-lubricating, no lubricant is needed.

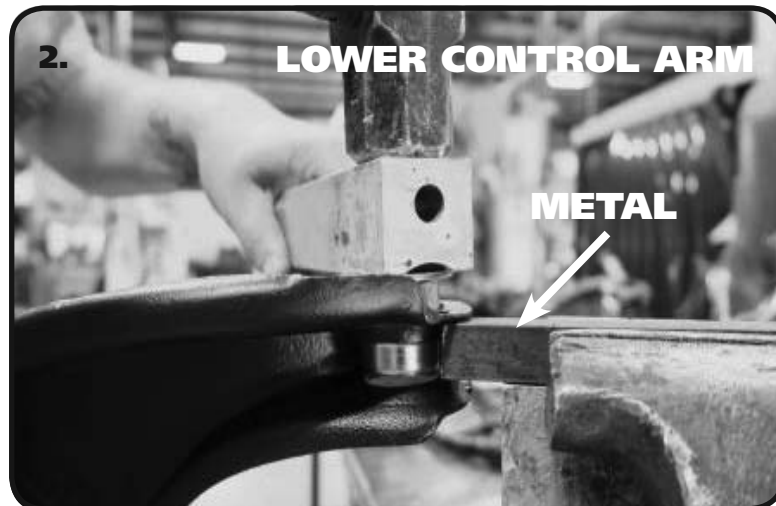

**2. Disassemble the Bushing being installed. If installing Bushings in the Upper Control Arm, insert the Cross Shaft before installing any Bushings.** Support the Back Side of the Flange the Bushing is being Installed in. Use a STIFF piece of Metal clamped in a Bench Vise for the Lower Control Arms (**Figure 2**). The Upper Control Arm can be supported by either the same piece of Metal or by the Bench Vise with the Jaws opened wide enough to let the Bushing Shell pass through (**Figure 3**).

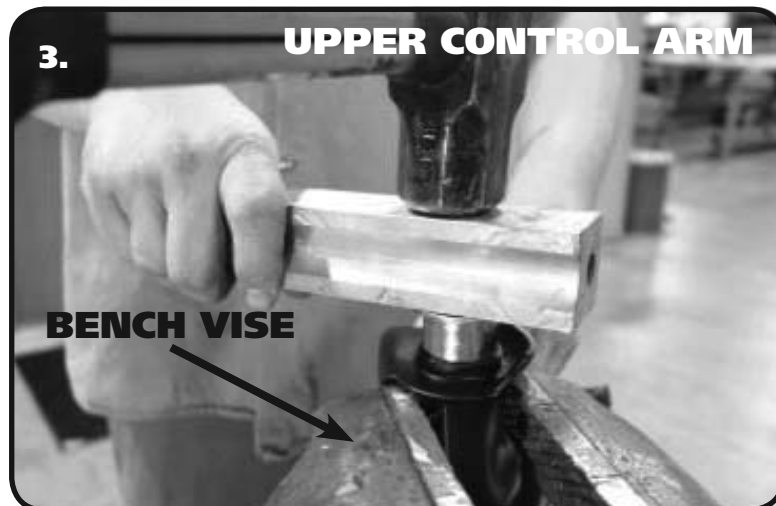

**3.** Use another Piece of Metal or Strong Wood to Drive the Outer Shell into the Control Arm until the Shell stops against the Control Arm.

**4.** Press the Delrin Bushing into the Bushing Shell followed by the Inner Sleeve. **DO NOT DRIVE IN WITH HAMMER.**

**5.** Reinstall the Outer Washer using the OEM Bolt, but replace the Lockwasher with the supplied Lockwasher. Tighten Hardware to eliminate any gaps between the Bushings and Cross Shaft.

**6.** Reattach Control Arms to Car. Use the OEM Hardware to attach the Upper and the Supplied 1/2"-13 x 3 1/2" Hex Bolts and Nylok Nuts to Install the Lower Control Arms.



### Part # 90000894 - A/F/X Tall Upper Balljoint



#### Recommended Tools

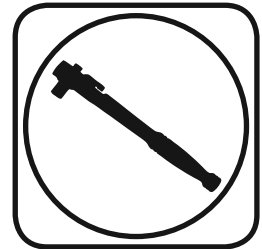

## A/F/X Tall Upper Balljoint Installation Instructions

Table of contents
Page 8..... Included component & Balljoint Installation



### Major Components .....In the box

Part #	Description	QTY
90000894	A/F/X Tall Upper Balljoint	2

### Balljoint Installation

The Tall Upper Balljoint is used in the StreetGrip Kit to help correct the Camber Gain. The Camber Gain on the OEM Suspension is incorrect and the Tall Balljoint repositions the Upper Control to help improve the Camber Gain.

**The Upper Balljoint will need to be disconnected from the Spindle. Refer to the Factory Service Manual for Disassembly.**



**1.** If your Balljoints are Bolted to the Control Arms, simply unbolt them. If your car has the Original Balljoints, they will be Riveted to the Control Arms. The Rivets can be removed by Grinding the Heads off and driving them out with a Hammer and Punch.

**NOTE. WE RECOMMEND MARKING DRIVER AND PASSENGER CONTROL ARMS.**



**2.** Insert the Balljoint into the Control Arm from the top side of the Control Arm with the Balljoint Pin Sticking down. Attach it to the Control Arm with the Hardware Supplied with the Balljoint. Torque the Hardware to 25 ftlbs. Engage the Balljoint Pin into the Spindle and install the Castle Nut Supplied. Torque the Castle Nut to 50 ftlbs and tighten to align Cotter Pin Hole. Install Cotter Pin through Hole and Bend Pins to prevent falling out.





**Part # 11162350/11162351 - 1967-1969 F-Body Front CoilSpring**



### Recommended Tools

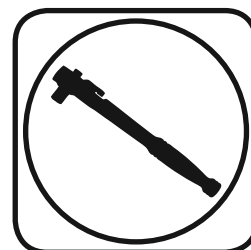

## 1967-1969 GM F-Body Front CoilSprings Installation Instructions

**CoilSpring # 55480700** Small Block /**55518800** Big Block **Installation**

Front dual-rate spring will allow the vehicle to transition small road irregularities via a soft spring rate. When the vehicle compresses the spring far enough (through large bumps or cornering), it transitions to the firmer spring rate to control the bump or body roll. We have worked closely with Hyperco to develop custom dual rates to ensure the best ride possible.

**The Front Control Arm Bushings and Upper Balljoint should be installed before installing spring. The Front Suspension should be assembled with the Lower Balljoint disconnected from the Spindle.**

1. Compress the CoilSpring with an Internal Spring Compressor with the **CLOSE COILS TO THE BOTTOM**.
2. With the OEM Spring Removed, insert the CoilSpring into the Pocket. **SPECIAL ATTENTION NEEDS TO BE PLACED ON THE LOCATION OF THE ENDS OF THE SPRINGS TO MAKE SURE THEY ARE CLOKED CORRECTLY** . The end of the CoilSpring will nest into the receiver area of the Control Arm. If you line up the bottom, the top will be correct.
3. While holding the Spring in place, Slowly Jack the Lower Control Arm up until the Lower Balljoint can be Engaged into the Spindle. Install the Castle Nut and Torque to 65 ftlbs then tighten as needed to align cotter pin hole. Install Cotter Pin. Once the Balljont is tight, remove the Spring Compressor.





### Part # 11169120 - 1967-1969 F-Body Front SwayBar

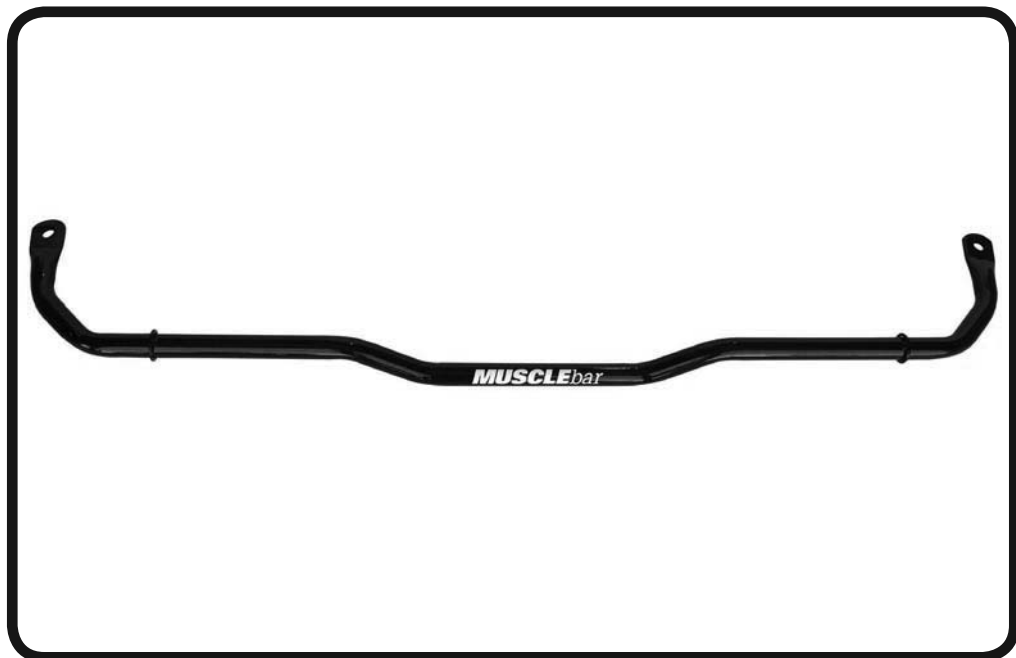

#### Recommended Tools

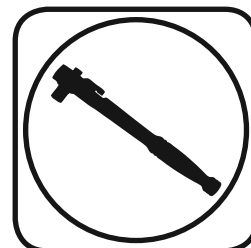

## 1967-1969 F-Body Front SwayBar Installation Instructions

#### Table of contents

- Page 11..... Included components and Hardware List
- Page 12..... SwayBar Installation
- Page 13..... SwayBar Installation

**ATTACH THE SWAYBAR TO THE FRAME BEFORE REINSTALLING THE FRONT SUSPENSION COMPONENTS.**



### Major Components .....In the box

Part #	Description	QTY
90002488	Front SwayBar	1
90002511	End Link Kit	1
70012402	Delrin Sway Bar Bushing Liner	2
90001100	Sway Bar Bushing Kit	1

Part #	Description	Usage	QTY
99311001	5/16"-18 x 1" Hex Bolt	Bushing Strap to Frame	4
99313003	5/16" SAE Flatwasher	Bushing Strap to Frame	4
99313002	5/16" Split Lockwasher	Bushing Strap to Frame	4

### Getting Started.....

**IT IS VERY IMPORTANT TO ATTACH THE SWAYBAR TO THE FRAME BEFORE REINSTALLING THE FRONT SUSPENSION.**

Remove the OEM Swaybar to prepare for the StreetGrip SwayBar installation.

This SwayBar kit utilizes a Delrin Liner in the SwayBar Bushing. The Delrin Liner allows the Swaybar to move freely and quietly in the Bushing. The Delrin is self-lubricating, no lubrication is required.



**1.** Insert the SwayBar through the frame into the OEM location. The SwayBar will be installed with the center of the SwayBar hanging down for engine clearance. The Delrin Liner is split on one side to ease installation. We found it easier to install by opening up the Liner enough to slide it onto the end of the SwayBar, then sliding it into position. It will open up and slide over the curves in the Bar. Install a Liner on each side of the SwayBar in the approximate location they will need to be when installing the SwayBar on the car.



### SwayBar Installation

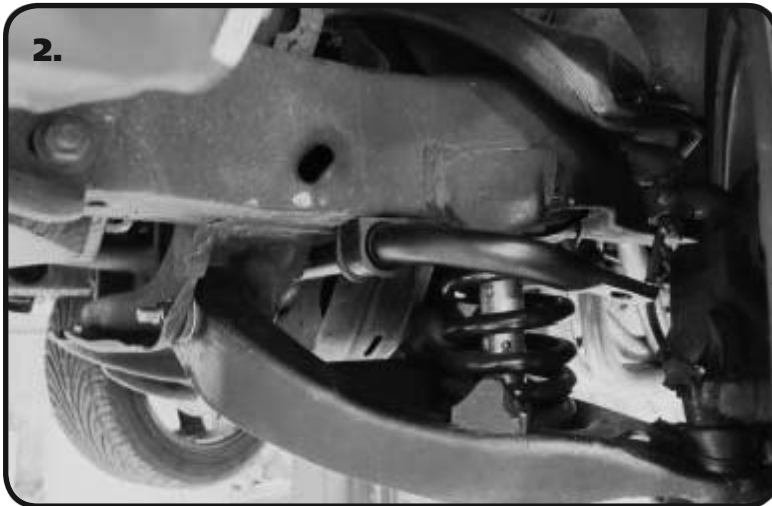

2. Open up the Poly SwayBar Bushings and install them over the Delrin Sleeves.



3. Install Bushing Straps Over the Poly Sway-Bar Bushings.

**Note:** Straps may need ground for clearance, depending on the shape of the frame/spring pocket.



4. Slide the SwayBar into position on the Car. You may need to move the bushing assemblies on the swaybar to get the slots in the straps to align with the OEM threaded holes. Install a 5/16" Lockwasher and 5/16" Flatwasher on each 5/16" Bolt and thread them into the OEM Threaded holes. Do **NOT** Complete tighten the Hardware. It will be left partially loose until the End Links are installed.



### SwayBar Installation



5. Install the End Links. Use the photo in Diagram "5" and Diagram "6" for proper installation. The Threads on the bolt should point up. Tighten the Hex Nut enough to slightly compress the Bushings.

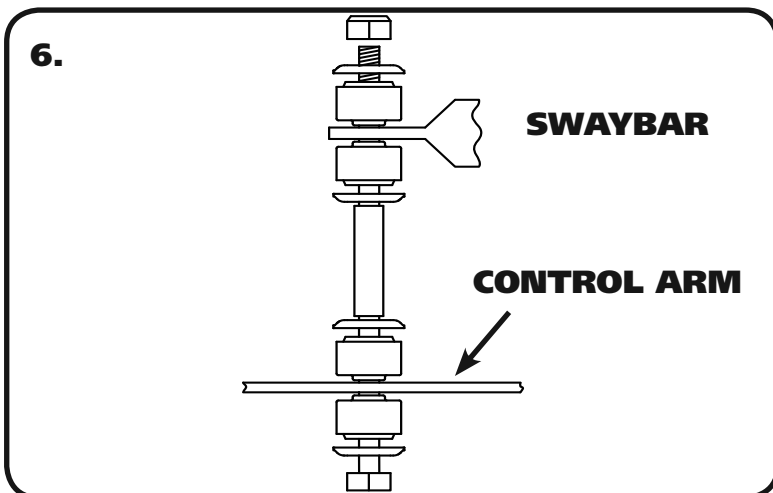

7. Tighten the Sway Bar Mounting Hardware. Center the mounting bolts in the slots before tightening the bolts.



**Part # 11164799** - 1967-1969 F-Body Composite Leaf Springs & Delrin Bushings

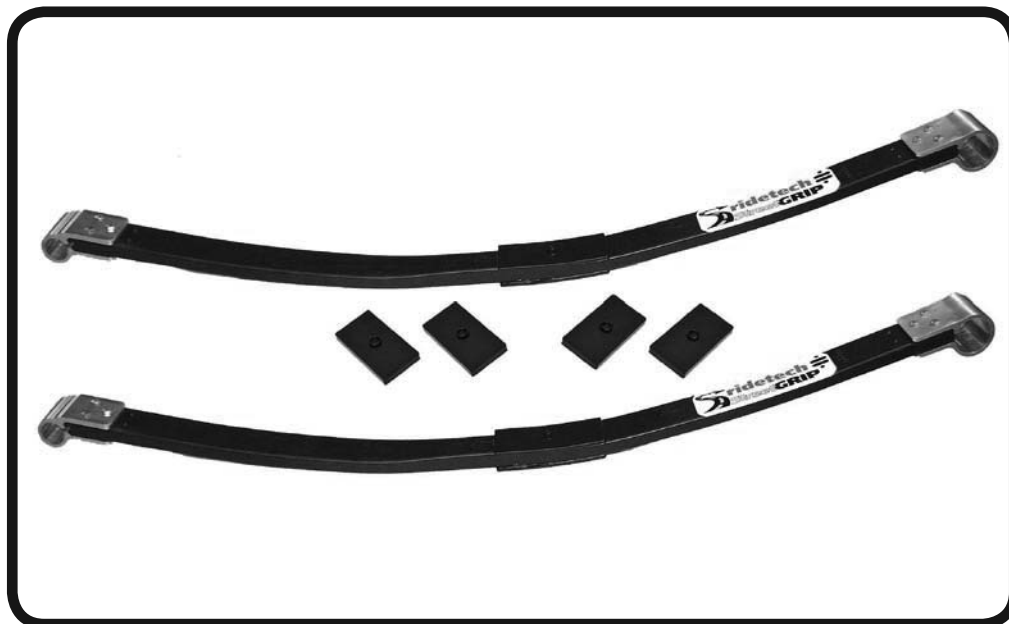

Recommended Tools

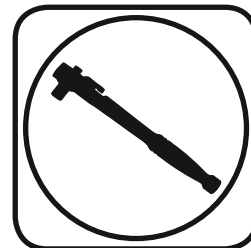

## 1967-1969 F-Body Composite Leaf Springs & Delrin Bushings

# Installation Instructions

### Table of contents

Page 15.....	Included components and Hardware List
Page 16.....	Leaf Spring Installation
Page 17.....	Multi & Mono Leaf Installation
Page 18.....	Mono Leaf Installation
Page 19.....	Mono Leaf & Finalizing Installation

**IT IS VERY IMPORTANT THAT NOTHING COMES IN CONTACT WITH THE COMPOSITE LEAF SPRINGS.**

THESE COMPOSITE LEAF SPRINGS WILL ACCEPT OEM LEAF SPRING BUSHINGS. THE RIDETECH STREETGRIP KIT HAS THE DELRIN LEAF SPRING BUSHINGS (11165399) PREINSTALLED FOR MAXIMUM PERFORMANCE.





### Major Components .....In the box

Part #	Description	QTY
90002550	Leaf Spring Blade Assembly w/70012431, 70012432, & 90000526 installed	2
90002497	Leaf Spring Clamping Plates	4
90002526	Mono Leaf Clamping Plate	2
70012433	Delrin Rear Shackle Frame Bushing	4
90000526	Inner Bushing Sleeve	2
90002496	Shackle Plate	4
	<b>Hardware</b>	
99501035	1/2"-13 x 5" Hex Bolt GR8	6
99502009	1/2"-13 Nylok Nut GR 8	6
99436001	7/16"-20 U Bolt	2
99431015	7/16"-20 x 2 1/4" Hex Bolt	4
99432002	7/16"-20 Nylok Nut	8
99433005	7/16" SAE Flatwasher	8
99371050	3/8"-16 x 1 1/2" Conical Body Bolt	6
99372009	3/8"-16 U-Nut	6

### Getting Started.....

**IT IS VERY IMPORTANT THAT NOTHING COMES IN CONTACT WITH THE LEAF SPRING.**

**THIS LEAF SPRING KIT WILL WORK WITH MONO LEAF OR MULTI LEAF DIFFERENTIALS, BUT THE INSTALLATION PROCESS VARIES BETWEEN THE TWO. THESE INSTRUCTIONS COVER BOTH SET-UPS, BE AWARE THAT YOU ARE DOING THE CORRECT STEPS FOR YOUR DIFFERENTIAL.**

**1.** Jack the car up and support it by the frame rails. You will need to raise and lower the rear differential with a jack to ease installation. With the car supported by the frame, put the jack underneath the rear end housing and raise the jack up just enough to support the differential. Disconnect the bottom of the shock and remove the rear leaf springs. Retain the OEM hardware. The OEM frame bushings will need to be removed and all debris removed from the holes to ease installation of the bushings.

**2.** The Shackle Plates and Hardware can be used to push the rear bushings into the frame location. Start the bushings into the frame and insert a 1/2"-13 bolt into a shackle plate. Insert the bolt/shackle plate into the bushing and install a second shackle plate on the bolt sticking through the bushing. Install a 1/2"-13 nut and tighten until the bushings bottom out on the frame. Remove the shackle plates and install the inner sleeve.



### Leaf Spring Installation

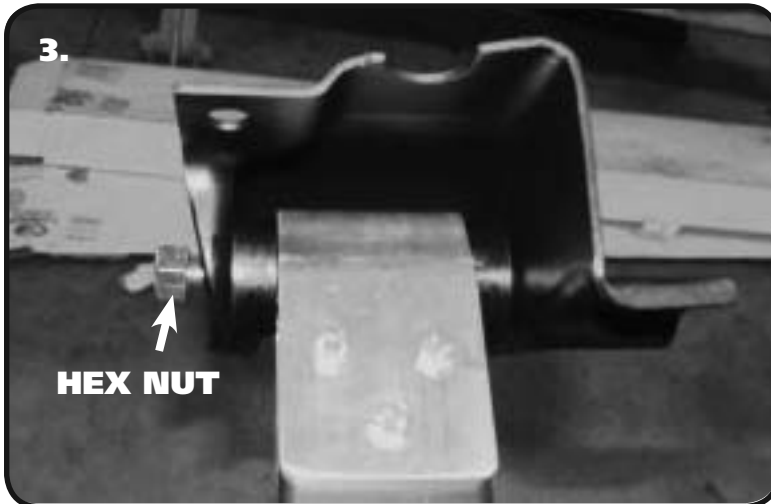

3. Bolt the **LARGE BUSHING END** of the Composite Leaf Spring into the OEM front leaf spring mount using a 1/2"-13 x 5" Hex Bolt and 1/2"-13 Nylok Nut. The Bolt must be installed with the threads pointing to the **OUTSIDE** of the car. Diagram #3 is the correct orientation.

**NOTE: Front spring pocket must be removed from car before installing new springs. New Hardware is supplied in kit.**

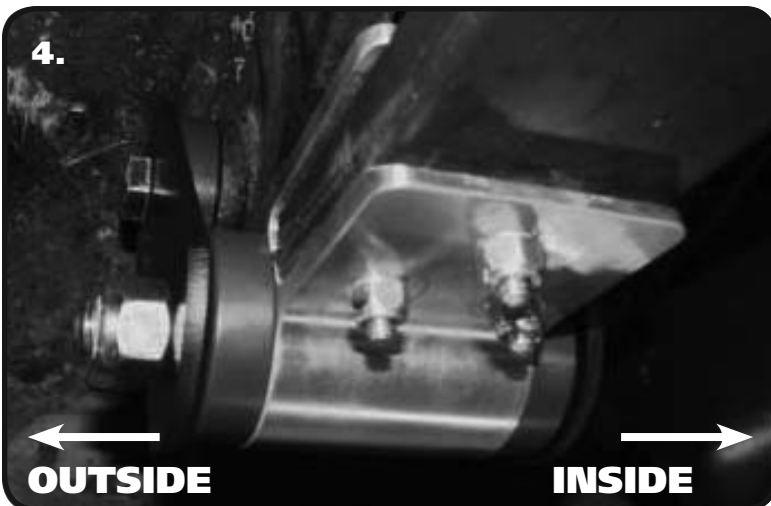

4. Attach the rear of the Composite Leaf Spring to the rear mount. If you are using the Ridetech Delrin Bushings, new Shackles and Hardware is supplied with them. Attach a Shackle Plate to each side of the Frame Bushing using a 1/2"-13 x 5" Bolt (WITH THREADS POINTING TO INSIDE OF CAR) and 1/2"-13 Nylok Nut. Do not tighten. Align the remaining bolt holes in the shackle plates with the sleeve in the rear Leaf Spring bushing. Install a 1/2"-13 x 5" Bolt (WITH THREADS POINTING TO OUTSIDE OF CAR) and 1/2"-13 Nylok Nut. Do Not tighten hardware, it will get tightened later.



5. Swing the Leaf Spring up and attached the front mount to the car using the supplied 3/8"-16 x 1 1/2" Conical Body Bolts and U-Nuts. Tighten Hardware

**Note:** You may have to jack the rear differential up enough to swing the leaf spring in place.

**IF YOU HAVE A MONO LEAF DIFFERENTIAL, SKIP TO STEP 8.**





### MULTI LEAF DIFFERENTIAL Installation

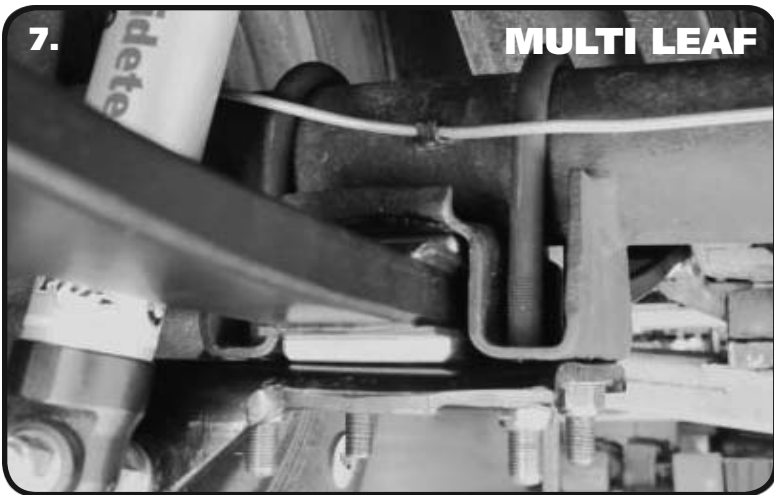
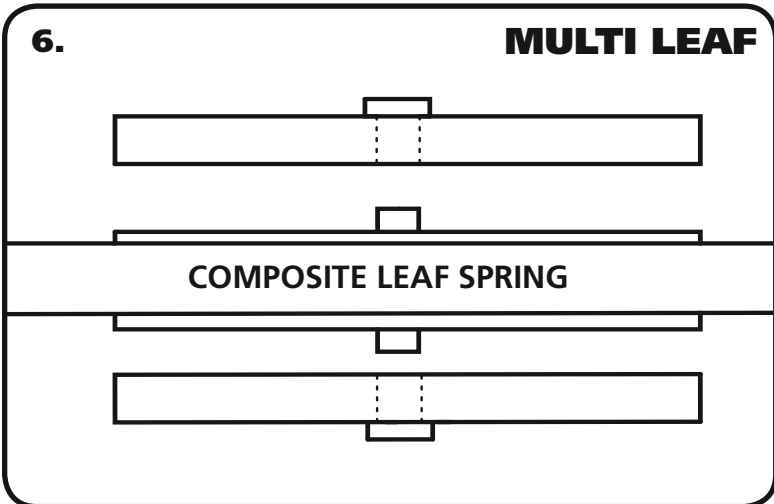

**STEPS 7 & 8 ARE FOR MULTI LEAF ONLY!**

**7.** The Composite Leaf Spring has to be clamped in place with the OEM lower plate. A Multi-Leaf car requires a Clamping Plate on the top and bottom of the leaf spring. The top and bottom locating pins need to be inserted into the holes in the Clamping Plates on the FLAT SIDE. The Clamping Plates have a pin on each one of them. They will need to be inserted into the holes on the leaf spring mount and lower plate to correctly position the rear differential.

**8.** Lower the differential onto the Leaf Spring with the top Clamping Plate in place, shown in Diagram "7". Align the top PIN into the HOLE in the OEM leaf spring mount. Install the lower Clamping Plate followed by the OEM lower mount being sure the Pins and Holes are aligned. Install the OEM hardware. Evenly tighten the hardware in a crisscross fashion. Torque the nuts to 55 ftlbs.

**Note:** When tightening the mounts, pay attention to the pads on the springs to make sure there is visible compression of the pads. .030" - .060" of compression is needed for the springs to be securely mounted. All of the clamping force needs to be on the spring itself.

**SKIP TO STEP #14 TO FINISH THE LEAF SPRING INSTALLATION**

### MONO LEAF DIFFERENTIAL Installation

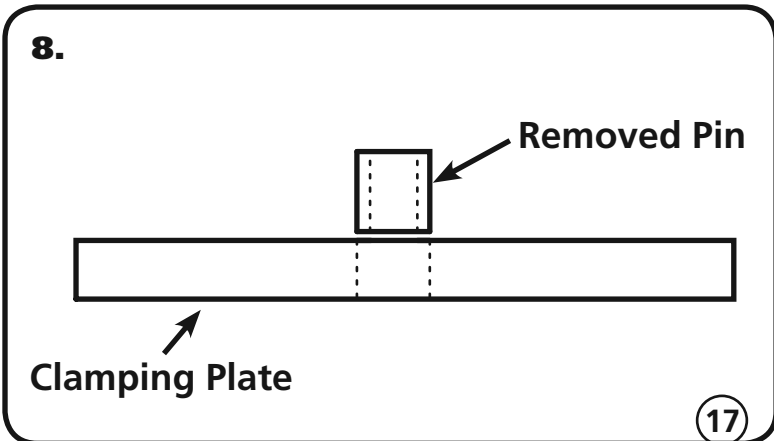

**9.** The kit contains 4 Clamping Plates that are all the same. For a Mono Leaf installation, the center pin will need to be removed from 2 of the plates. The pin can be knocked out with a hammer and punch.



### MONO LEAF Installation

9.

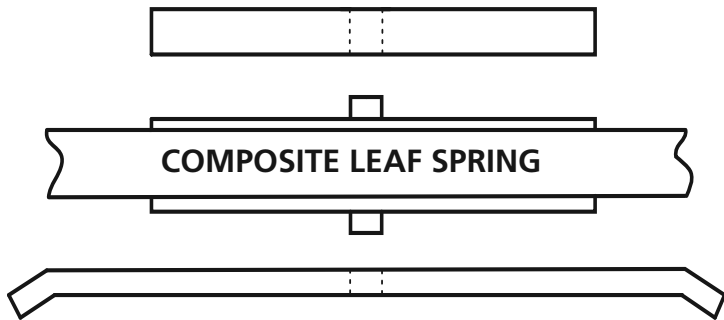

**MONO LEAF**

*Diagrams 9, 10, & 11 will be used to aid in the installation of the Clamping Plates on a Mono Leaf Differential.*

9. The Composite Leaf Spring will be clamped in place with the OEM lower plate. This setup utilizes a Clamping Plate on the top and bottom of the leaf spring. **The Locating Pin on the Composite Leaf Spring needs to be inserted into the holes on the Clamping Plates.** The Clamping Plate with the **Pin REMOVED** is used on the **TOP**. The Locating Pin on the bottom of the leaf spring will need to be inserted into the center hole in the Lower Clamping Plate, this will position the differential correctly.

10.

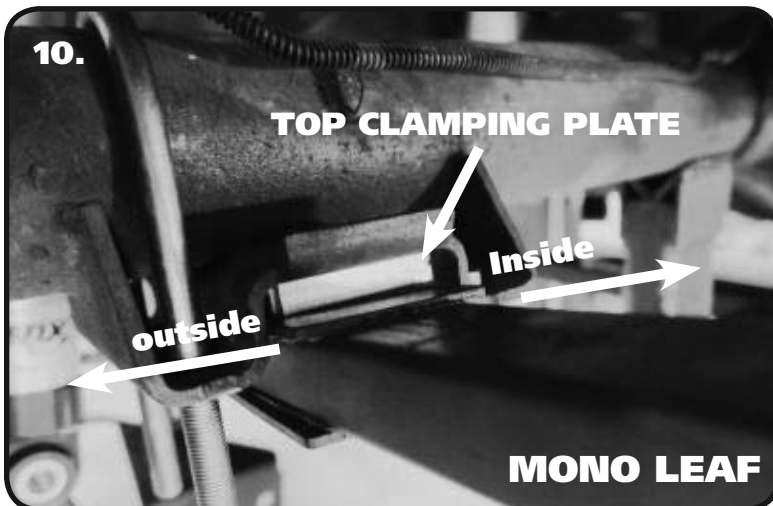

**MONO LEAF**

10. Remove the OEM Hardware from the OEM leaf spring mount, it will be replaced with hardware supplied in the kit. The new Hardware includes (1) 7/16 U Bolt, (2) 7/16"-20 x 2 1/4" Hex Bolts, (4) Flat washers, & (4) 7/16-20 Nylok Nuts per side. The U Bolt will replace the outer OEM hardware, the 7/16" x 2 1/4" bolts replace the inner OEM hardware. Install the U Bolt and Hex Bolts.

11.

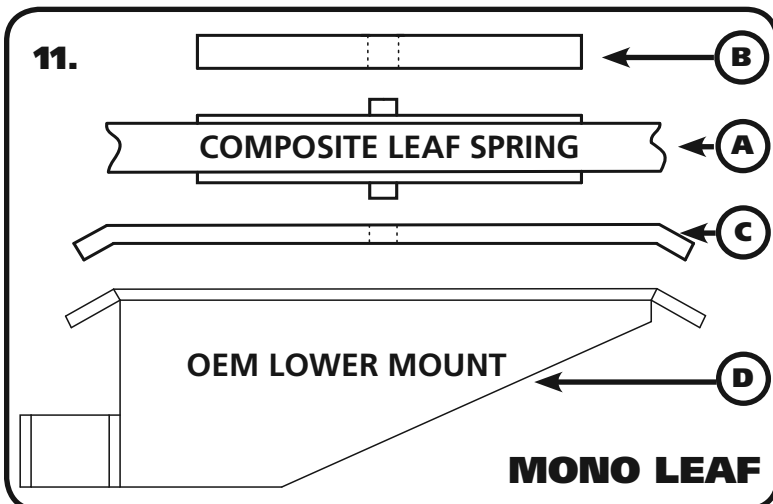

**MONO LEAF**

11. Align the top **PIN** into the **HOLE** in the Top Clamping Plate(**B**). Lower the differential onto the Leaf Spring(**A**) with the Top Clamping Plate(**B**) centered on the pin. Install the Lower Clamping Plate(**C**) by sliding it up on the mount hardware. It may be necessary to reposition the differential to get the **BOTTOM** Locating pin in the **HOLE** in the Lower Clamping Plate(**C**). Next, install the OEM lower mount(**D**) being sure the Pins and Holes are aligned and the lower shock mount is in the correct position.



### MONO LEAF Installation

12. Install a 7/16" Flatwasher and 7/16-20 Nylok Nut on each U bolt and Hex Bolt. Evenly tighten the nuts to a Torque of 55ftlbs. **Note:** When tightening the mounts, pay attention to the pads on the springs to make sure there is visible compression of the pads. .030" - .060" of compression is needed for the springs to be securely mounted. All of the clamping force needs to be on the spring itself.

Continue to Step 13

### Finalizing Installation

13. Tighten the Bushing hardware, torquing it to 75 ftlbs. The Delrin Bushings will not bind, so it isn't necessary to have the car at ride height. If using OEM style rubber bushings, the car will need to be on the ground at ride height before tighten the bushing hardware.

14. Install the Ridetech HQ Series shocks. Refer to the shock instructions.

15. **DOUBLE CHECK TO MAKE SURE NOTHING IS COMING INTO CONTACT WITH THE LEAF SPRING.**

### Front & Rear HQ Series Shocks



#### Recommended Tools

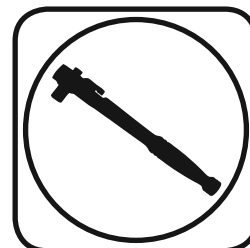

## Front & Rear HQ Series Installation Instructions

#### Table of contents

Page	19.....	Rear Shock Installation
Page	20.....	Front Shock Installation
Page	21.....	Front Shock Installation & Adjustment



### Rear - Part # 22189842 - 7.55" HQ Series Shocks

#### Major Components .....In the box

Part #	Description	QTY
22889999	7.55" Stroke Shock	2
70011141	Bushing Support Washer	4
70011140	Stem Bushing	4
99372006	3/8"-24 Thin Jam Nut	4
90002102	1/2" ID Shock Sleeve	2
70011194	7/16" ID Shock Sleeve	2
90002103	5/8" ID Shock Sleeve (Installed in Shock)	2
90001619	Cantilever Pin	2
90000471	Cantilever Pin Spacer	2
70011138	3/4" ID Shock Bushing	2

### Shock Installation

The Rear Shocks will be installed in conjunction with the Rear Leaf Springs.

1. With the OEM shock removed, attached the stud top to the OEM mount using Step #1 on Page 22 for proper stud top assembly procedure.

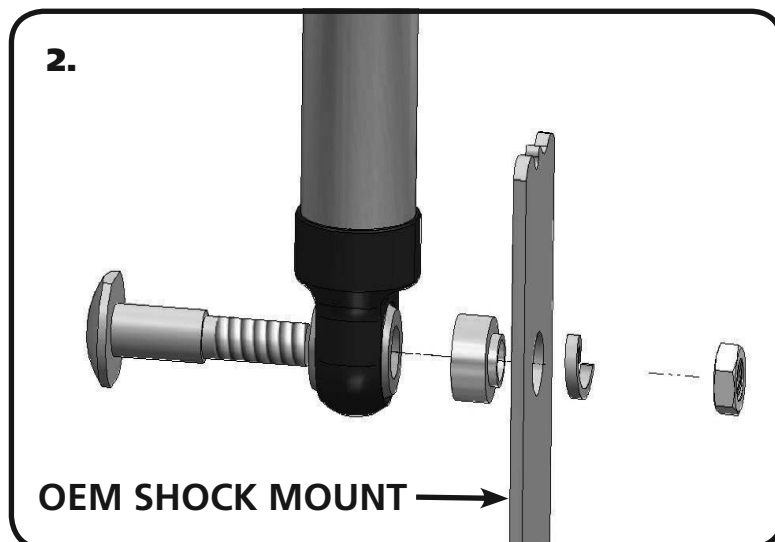

2. The Lower Shock is Bolted to the Lower OEM Mount using the supplied Cantilever Pin. Insert the Cantilever Pin into the Shock Bushing. Next, Slide the Aluminum Spacer onto the Threads of the Cantilever Pin. With the Leaf-Springs in place, Jack the Rear Differential up until the Shocks can be Bolted in place. Insert the Assembly into the OEM Shock Hole. Install the supplied Lockwasher and Hex Nut onto the Threads and tighten. If it uses a 7/16" or 1/2" thru bolt, install the 7/16" or 1/2" Bushing Sleeve in the shock and use the OEM lower hardware to attach the lower.



### Front- Part #22149846 - 4.75" Stroke HQ Series Shocks

#### Major Components .....In the box

Part #	Description	QTY
22849599	4.75" Stroke Shock	2
70011139	5/8" ID Shock Bushing (Installed in Shock)	2
90002069	Standard Trunnion (Installed in Shock)	2
70011141	Bushing Support Washer	4
70011140	Stem Bushing	4
99372006	3/8"-24 Thin Jam Nut	4

**Due to manufacturing tolerances it may be necessary to clearance the Control Arm to get the Shock through the Control Arm opening.**

### Shock Installation

Before installing the Shocks, the Control Arm Bushings, Upper Balljoint, and Coil-Springs should be installed.

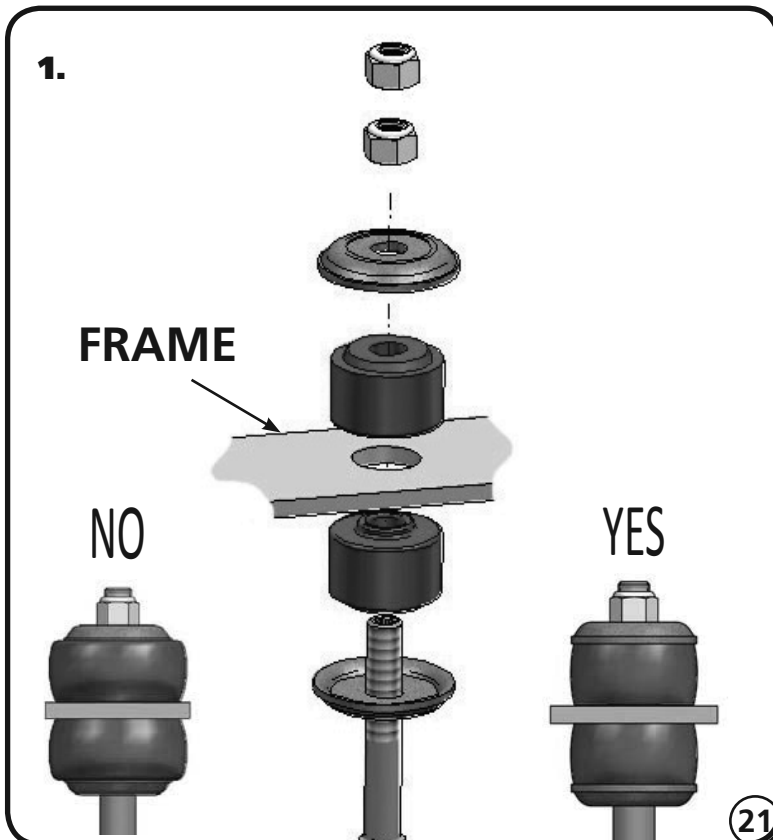

1. With the OEM shock removed, install the Ridetech shock. Install a Bushing Support Washer on to the shock shaft followed by a Shock Stem Bushing. Insert the assembly through the factory shock hole in the frame. With the shock stud sticking through the frame, install a Shock Stem Bushing on to the shock stud followed with a Bushing Support Washer. Install a 3/8"-24 Thin Jam nut onto the threads and tighten to 35 inlbs. The Bushing should be tight, but not to the point that the bushing is bulging past the Support Washer. Install the 2nd 3/8-24 Thin Jam nut and tighten it against the first nut. Reinstall Adjuster Knob.

**NOTE:** It may be necessary to remove the OEM Speed Nuts from the Control Arm to allow room for the Shock to slide through the opening in the Control Arm. The Speed Nuts can be reinstalled after the Shock is in position.



### Shock Installation and Adjustment

2.

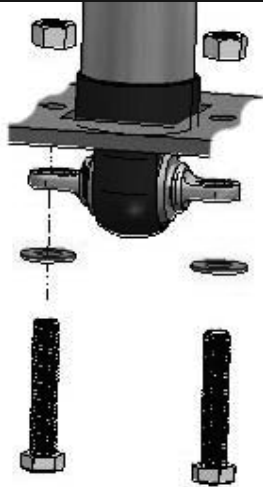

2. Attach the Trunnion to the OEM Control arm using the OEM hardware. It may be necessary to rotate the Trunnion to get it in the correct position. This can be done by sticking a screwdriver in one of the slots and spinning the trunnion in the shock bushing.

### Shock adjustment 101- Single Adjustable

#### Rebound Adjustment:

How to adjust your new shocks.

The rebound adjustment knob is located on the top of the shock absorber protruding from the eyelet or stud top. You must first begin at the ZERO setting, then set the shock to a street setting of 12 or handling setting of 8.

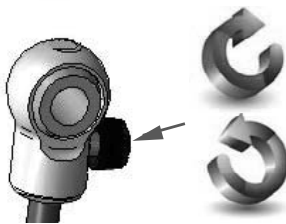

-Begin with the shocks adjusted to the ZERO rebound position (full stiff). Do this by rotating the rebound adjuster knob clockwise until it stops.

-Now turn the rebound adjuster knob counter clockwise 12 clicks. This sets the shock at 12 for a street setting. If your after a handling setting only go 8 clicks.

#### Take the vehicle for a test drive.

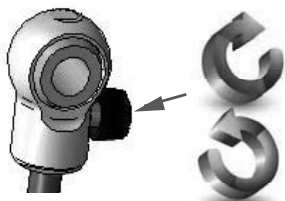

-if you are satisfied with the ride quality, do not do anything, you are set!

-if the vehicle is too soft increase the damping effect by rotating the rebound knob clock wise 3 additional clicks.

-if the vehicle is too stiff rotate the rebound adjustment knob counter clock wise 2 clicks and you are set!

Take the vehicle for another test drive and repeat the above steps until the ride quality is satisfactory.

#### Note:

**One end of the vehicle will likely reach the desired setting before the other end. If this happens stop adjusting the satisfied end and keep adjusting the unsatisfied end until the overall ride quality is satisfactory.**