



Part # 11370297- 88-98 GM C1500 Air Suspension System

Front Components:

11370910	Front CoolRide & Shock Kit
11371499	Front Lower StrongArms
11373699	Ront Upper StrongArms
11379300	Front Spindles
11379120	Front MuscleBar

Rear Components:

11377199	Rear Wishbone System
21150801	Rear ShockWave

Recommended Tools

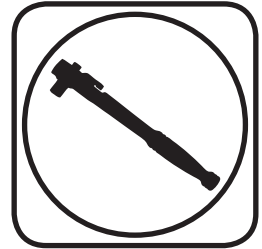

88-98 GM C1500 Air Suspension System Installation Instructions

Table of contents

Pages 2-4.....	Front CoolRide with HQ Series Shocks
Pages 5-7.....	Lower StrongArms
Pages 8-10.....	Upper StrongArms
Pages 11.....	Spindles
Pages 12-14.....	Front MuscleBar
Pages 15-32.....	Rear Wishbone Suspension
Pages 33-35.....	Rear ShockWave
Pages 36.....	Shock Adjustment

THE SPINDLES IN THIS KIT ARE DESIGNED FOR THE HEAVY DUTY BRAKES





Part # 11370910 - 88-98 C1500 Front CoolRide with HQ Series Shocks

COOLRIDE KIT

Components:

2	90006873	224c air springs
2	90000024	Upper air spring cup (Tall)
2	90001083	Medium bump stop

Hardware:

2	99435002	7/16" x 8" stud	Upper cup to frame
2	99432001	7/16" USS Nyloc nut	Upper cup to frame
2	99433002	7/16" SAE flat washer	Upper cup to frame
2	99371001	3/8 x 3/4 USS bolt	Air spring to lower bracket
4	99372002	3/8" USS Nyloc nut	Air spring to upper cup
6	99373003	3/8" SAE flat washer	Air spring mounting
2	99373005	3/8" lock washer	Air spring to lower cup

SHOCK KIT

Shock:

2	22849999	HQ Smooth Body Shock Cartridge
2	70011138	3/4" ID Shock Bushing
2	90002103	5/8" ID Inner Sleeve

Components:

4	70011140	Stem Bushings
4	70011141	Stem Washers
1	90000437	Drivers Side upper shock bracket
1	90000438	Passengers Side upper shock bracket
2	90000471	Aluminum shock spacer
2	90001619	Shock stud

Hardware:

6	99371004	3/8" x 1-1/4" USS bolt	Upper shock mount to frame
6	99372002	3/8" USS Nylok nut	Shock mounting
12	99373003	3/8" SAE flat washer	Shock mounting
4	99372006	3/8"- 24 Thin Jam Nut	Upper Shock Stud





CoilOver Installation

THE SHOCK BRACKETS NEED TO BE INSTALLED BEFORE THE AIRSPRINGS.



1. The large hole in the bracket will align with large hole in the frame. Using the bracket as a template, drill the remaining holes in the frame. Use 3/8" x 1 1/4" bolts, Nylok nuts and washers to secure the bracket. The inside of the frame can be accessed from the coil spring pocket to install the nuts.

Note: This bracket must be mounted BEFORE installing the air spring.



2. Apply thread sealant to the air fitting and screw it into the air spring. Assemble the upper cup bracket to the air spring, using 3/8" Nylok nuts and flat washers. Thread the 8" stud into nut welded to the bottom of the cup.



3. Place the assembly up into the upper coil spring pocket; the stud will go through the factory shock hole. Fasten with a 7/16" Nylok nut and flat washer.

Note: The airline must also be routed at this time.

4. Fasten the bottom of the air spring to the lower StrongArm using a 3/8" x 3/4" bolt, lock washer and flat washer.



5. Make sure the air spring does not rub on anything through full suspension travel. This will damage the air spring and is not a warrantable situation. Although it is acceptable to allow it to touch the lower control arm when fully deflated.

6. The final step is to have the vehicle realigned. You will want to have this done at ride height. Ride height is determined by air spring height. This spring should be approximately 4 3/4" tall, which should occur around 85-100 psi. This will vary to driver preference and vehicle weight.



7. Attach the shock to the upper mount as shown in the picture.

8. Push the shock stud through the lower shock eye and aluminum spacer. Then through control arm and fasten with supplied nut.



Part # 11371499

1988-1998 GM C1500 Lower CoolRide StrongArms

Components:

1	90000439	Driver side lower arm
1	90000440	Passenger side lower arm
2	90000897	Ball joints
8	70010759	Delrin bushing half
2	90000198	Inner bushing sleeve – 3" long
2	90000199	Inner bushing sleeve – 3.5" long

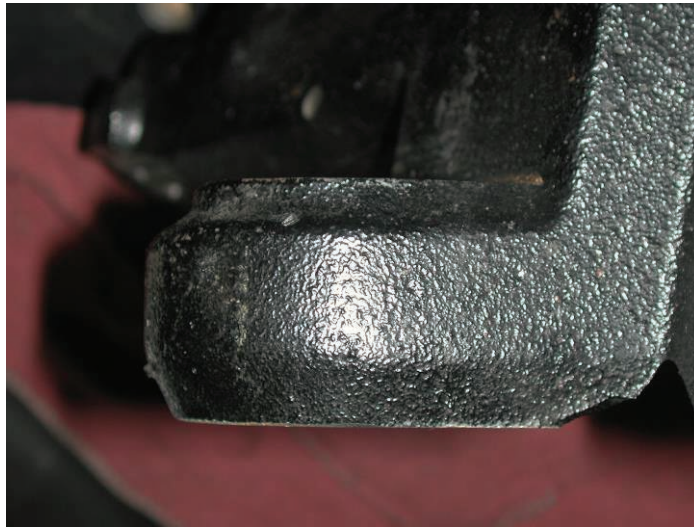

IT MAY BE NECESSARY TO BEVEL THE BOTTOM OF YOUR SPINDLE SIMILAR TO THE IMAGE. YOU WILL NEED TO CHECK YOUR FITMENT TO VERIFY.





Lower Control Arm ComponentsIn the box

Item #	Description	Qty.
1.	Driver side arm	1
2.	Ball joint	1
3.	Delrin bushing half	4
4.	Inner bushing sleeve – 3"	1
5.	Inner bushing sleeve – 3.5"	1

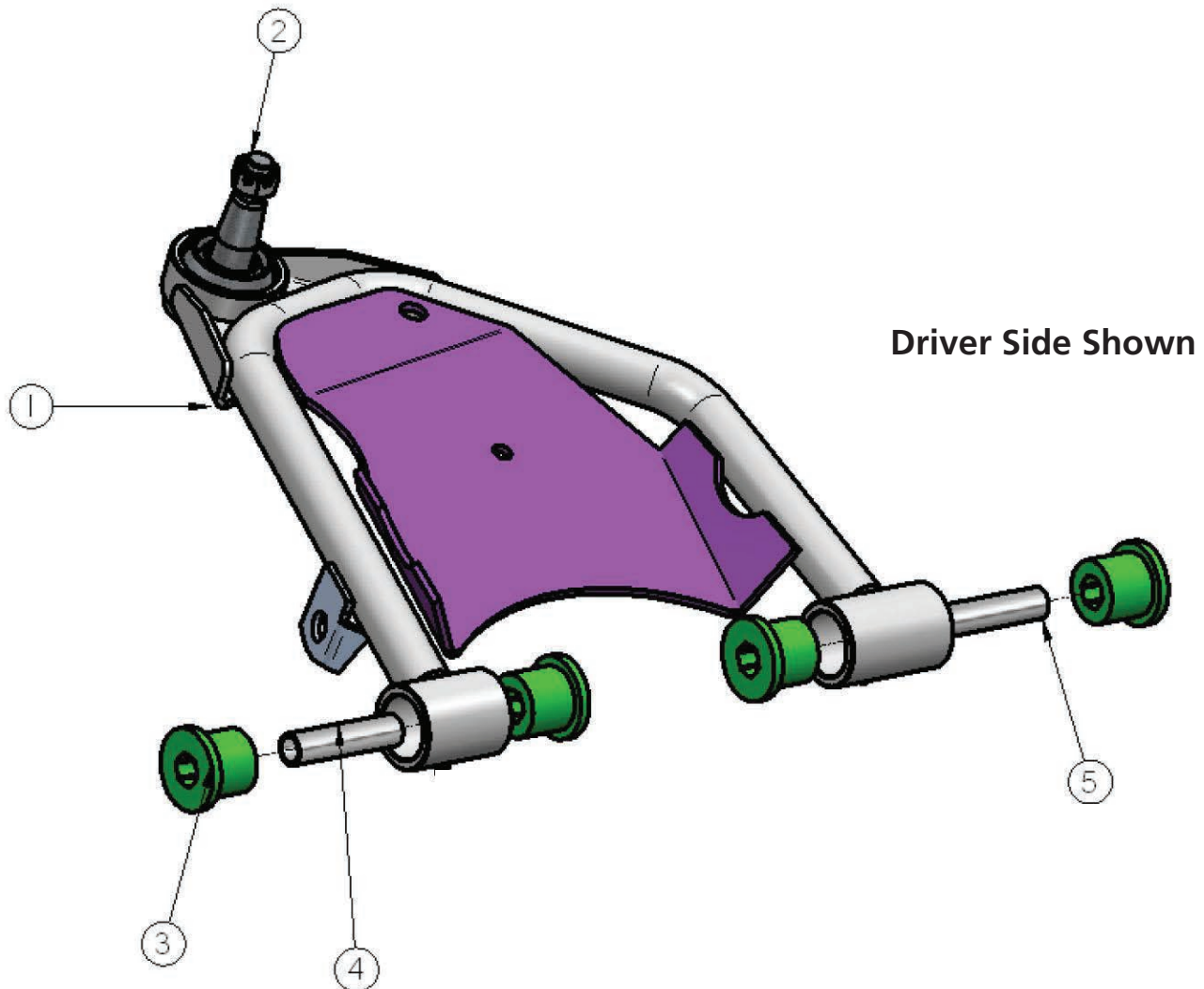



Lower Control Arm Installation



1. After removing the factory lower control arm, clean the bushing mounting surfaces on the frame.
2. Fasten the lower arm to the frame using the factory hardware. The Steering Stop will go to the rear of the truck.

Note: On some trucks the frame brackets may be pinched and will need to be spread back apart to allow bushing to slide in.

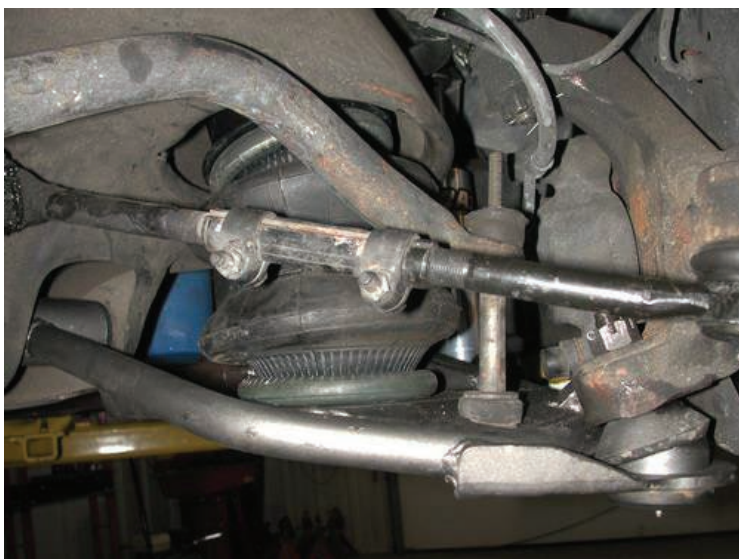

3. Slide the ball joint boot over the stud, then push the stud up through the spindle. Secure w/ the new castle nut and cotter pin supplied.
4. Attach to the air spring & shock to the lower arm using the hardware supplied w/ those kits.



Part # 11373699 - 88-98 GM C1500 Front Upper StrongArms

Recommended Tools

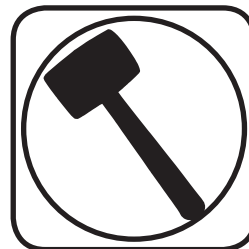
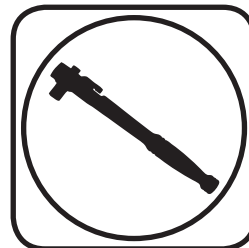
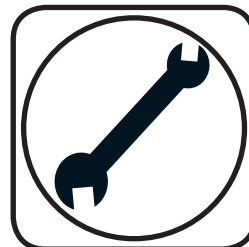

1988-1998 GM C1500 Upper StrongArms Installation Instructions

Table of contents

Page 9..... Included Components & Getting Started
Page 10-11..... StrongArm Installation





Lower Control Arm ComponentsIn the box

Item #	Part Number	Description	QTY
1	90000433	Driver Upper Control Arm	1
1	90000434	Passenger Upper Control Arm	1
2	90000900	Upper Ball Joint	2
3	70010759	Delrin Control Arm Bushing	8
4	90001097	Delrin Bushing Inner Sleeve	4
5	90000900 KIT	Upper Ball Joint Bolts	8
6	90000900 KIT	Upper Ball Joint Hex Nuts	8
7	90000900 KIT	Upper Ball Joint Lock Washers	8

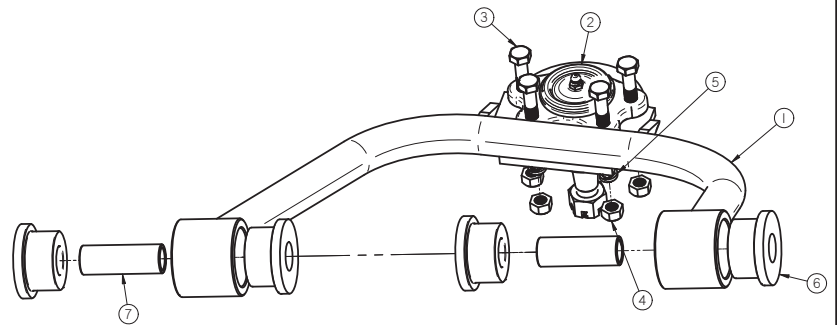
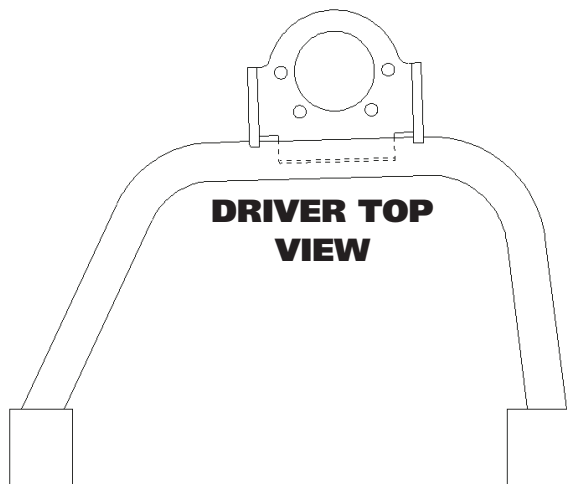

Getting Started.....



1. The OEM upper control arms will need to be removed from the truck. Start by disconnecting the brake line from the upper control arm.



StrongArm Installation



2. Remove the Upper Control Arms. The Camber Bolts need to be reinstalled in the same positions they are removed from. We recommend marking their positions for reassembly. Refer to the factory service manual for disassembly procedure. After removing the factory upper control arm, clean the bushing mounting surfaces on the frame.

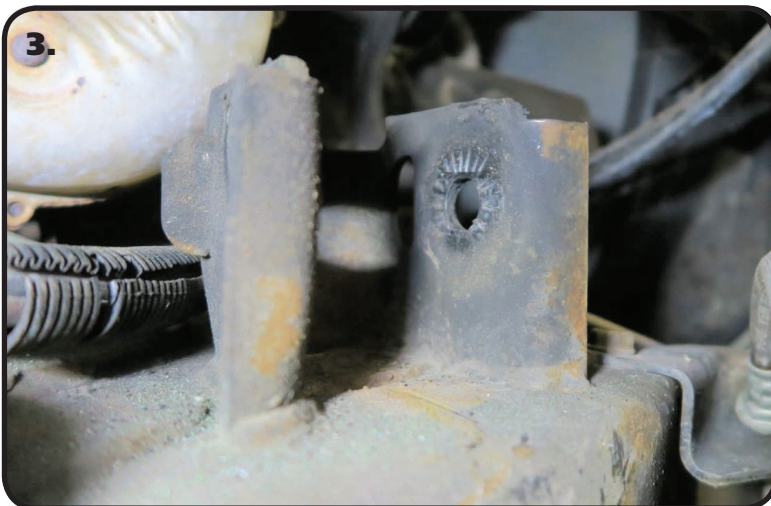

3. If your truck has never needed the caster or camber changed, it may still have the locating slugs in the upper control arm mounts. **See Image 3.** Skip to Step 6 if your truck has already had the locating slugs removed.



4. They make a tool for removing the locating slugs or you can knock them out with an air chisel. It is best to use a blunt tool in the air chisel to knock them out. If you are having a shop align your truck, they will have the tool needed to knock the slugs out.



Part # 11379300 - 1988-1998 C1500 Drop Spindles



Recommended Tools

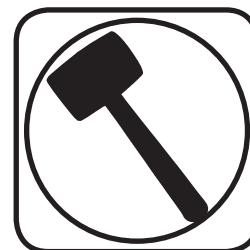
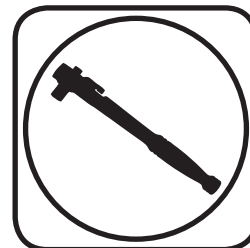
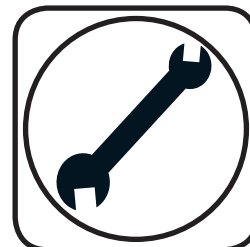

1988-1998 C1500 Drop Spindles

Installation Instructions

Installation

Refer to the instructions included with the spindles.

THESE SPINDLES ARE DESIGNED FOR THE HEAVY DUTY BRAKES





Part # 11379120 - 1988-1998 GM C1500 Front SwayBar



Recommended Tools

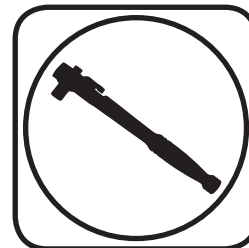
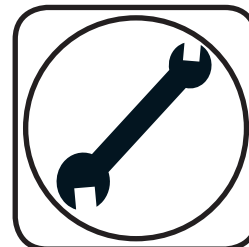

1988-1998 GM C1500 Front SwayBar Installation Instructions

Table of contents

- Page 13..... Included Components and Hardware List
- Page 14..... SwayBar Installation

Hardware Torque Specifications

M10-1.5..... 37 ftlbs



Major ComponentsIn the box

Part #	Description	QTY
90001228	Front SwayBar	1
90001258	SwayBar End Link T-Bushing	4
70012913	Delrin Sway Bar Bushing Liner	2
90002513	Bushing Strap	2
70013130	SwayBar Bushing	2
90001257	Bushing Mount Adapter	2
70014491	Locking Ring	2

END LINK ASSEMBLY

Part #	Description	QTY
90001256	90 Degree End Link Adapter	2
90002571	90 Degree End Link	2
99375008	3/8"-16 x 3" Fully Threaded Stud	2
90002930	End Link Kit	2

HARDWARE KIT99010086

QTY	Part Number	Description
ADAPTER PLATE		
2	99111001	M10-1.5 x 30mm Flat Head
1	90002263	Red Loctite

QTY	Part Number	Description
BUSHING STRAP		
2	99111003	M10-1.5 x 40mm Hex Bolt
2	99111011	M10-1.5 x 20mm Hex Bolt
4	99113001	M10 Split Lock Washer
4	99433002	7/16" SAE Flat Washer

Getting Started.....

This SwayBar Kit utilizes a Delrin Liner in the SwayBar Bushing. The Delrin Liner allows the SwayBar to move freely and quietly in the Bushing. The Delrin is self-lubricating, no lubrication is required.

1. Jack the vehicle up to a safe working height and support with jack stands. Make sure the jack stands are stable before working under the car.
2. Remove the stock sway bar.



4. Open the Delrin Liner at the split and slip it over the SwayBar. Position it in the area that the bushing will ride based on the location of the stock swaybar. Do this on both ends of the swaybar. Next, open the SwayBar Bushing at the split and slide it **OVER** the Delrin Liner. Do this on both Delrin Liners.



5. Slip the Bushing Straps over the SwayBar Bushings.

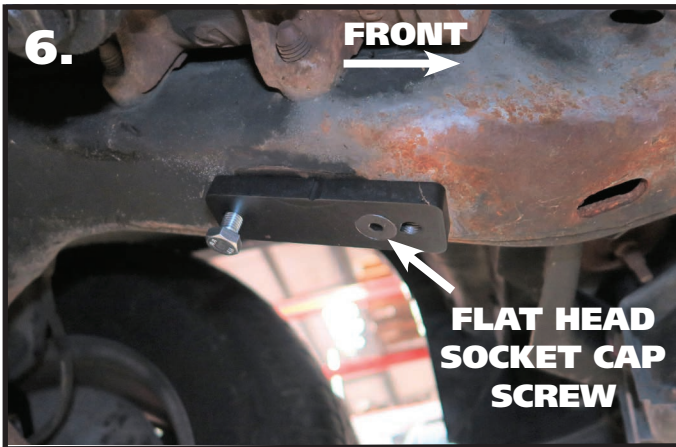

6. Hold the Frame Plate up to the OEM holes, the Counter Sunk hole will be positioned over the front hole with the slot to the rear. Apply Red Loctite to the Flat Head Bolt. Thread a Bolt into the rear hole to help keep the plate straight. Torque the flat head bolt and remove the rear bolt.

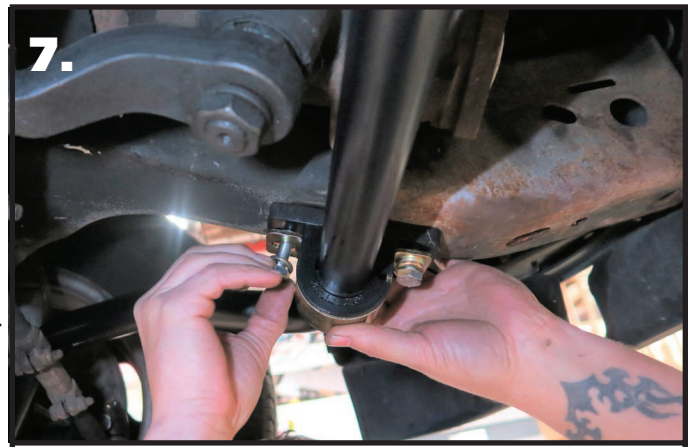

7. Slide the SwayBar into position on the truck with the SwayBar arms above the tie rods. Install a Lock Washer & Flat Washer on the each M10 Hex Bolts. A 30mm goes in the front, with a 40mm going in the rear. Do **NOT** complete tighten the hardware at this time.



8. Install a T-Bushing on each of the 90 degree end links. The t-bushings are installed with the large diameter against the shoulder of the end link.



9. Insert the 90 degree end link/t-bushing into the swaybar end with the threads pointing toward the coilspring. Install a 2nd t-bushing with the small diameter into the swaybar. Install the nut and torque. Do this for both sides.

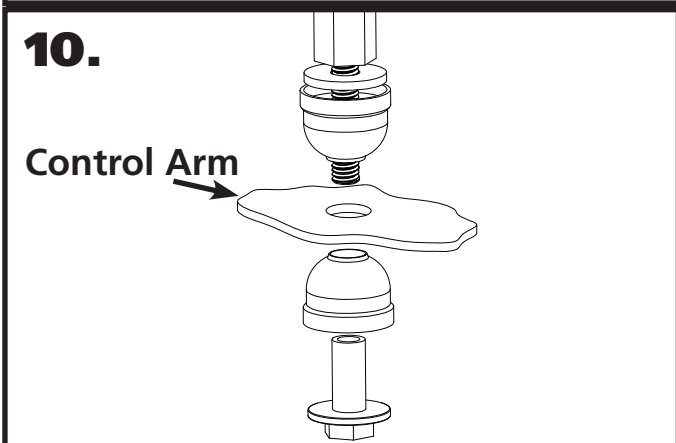

10. Install the End Links using **Diagram 10** as a reference. Install both end links before tightening the end link hardware. Tighten the end link barrel nut until it is flush with the end of the bolt, and then tighten it 2 more complete rounds.



11. Center the swaybar and torque the strap hardware. Install the stop rings against the swaybar bushing. The stop rings will go against the inner side of the bushing. Take the stop rings apart and reassemble them against the bushing and tighten.



Part # 11377199

1988-1998 C1500 Rear Bolt-On Wishbone Suspension System

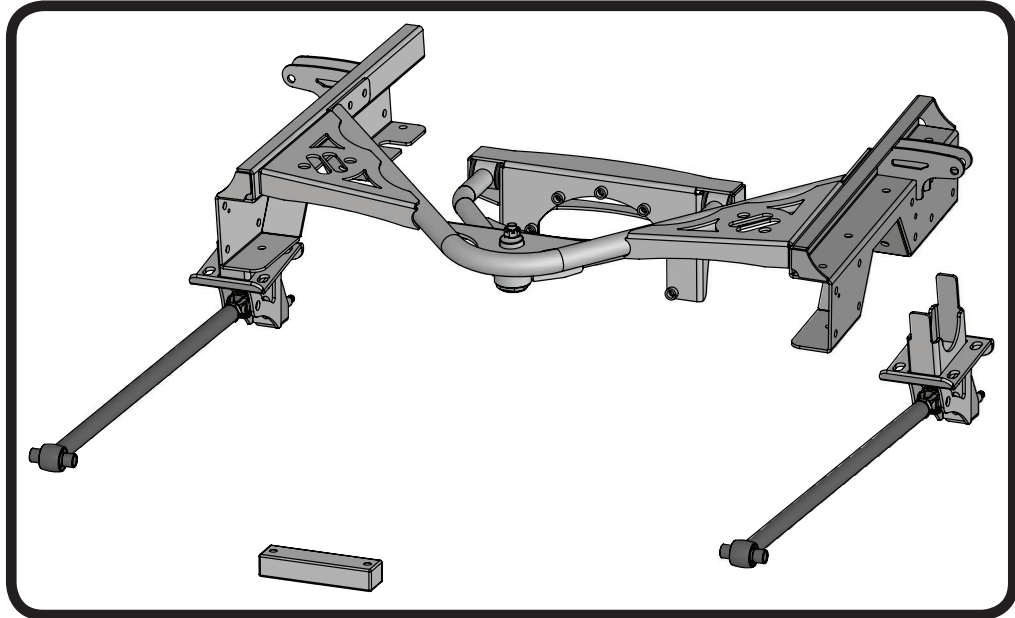

Recommended Tools

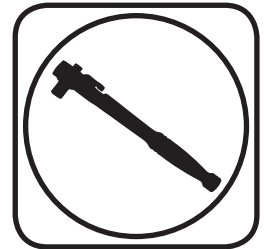

1988-1998 C1500 Rear Suspension Installation Instructions

Table of contents

Page 16-17.....	Included Components
Page 18.....	Hardware List & Disassembly
Page 19.....	Disassembly & Getting Started
Page 20-22.....	C-Notch Installation
Page 23.....	Lower Axle Mount Installation
Page 24.....	Installing Lower Bars
Page 25.....	Installing Lower Bars & Wishbone Assembly
Page 26-27.....	Wishbone Axle Mount Installation
Page 28.....	Wishbone Installation
Page 29.....	Shockwave/CoilOver Mounting
Page 30.....	Carrier Bearing Mount
Page 31.....	E-Brake Cable Relocation
Page 32.....	Bed Modification





Major ComponentsIn the box

Item #	Part #	Description	QTY
1	90001271	Driver C-Notch	1
2	90001272	Passenger C-Notch	1
3	90001273	Rear Upper Control Arm Mount Crossmember	1
4	90001274	Rear Upper Wishbone	1
5	90001275	Rear Upper Control Arm Differential Mount	1
6	90001276	Lower Axle Bracket	2
7	90001277	Lower Bars - Set to 32 3/4"	2
8	90001329	Carrier Bearing Spacer - used on carrier bearing equipped trucks	1
9	70013364	RH R-Joint Threaded Housing	2
10	90001617	5/8" Shock Stud	2
11	90001624	Aluminum Lower Shock Mount	2
12	70013334	R-Joint Spacers - rear lower bar	4
13	70013769	R-Joint Spacer - Lower Bars - Front	4
14	70010759	Delrin Bushings - installed in upper control arm	4
15	90000549	Delrin Bushing Inner Sleeves - installed in upper control arm	2
16	90000895	Ball Joint - Upper Wishbone	1
17	99752004	3/4"-16 Jam Nut - Installed on Lower Bars	2
	90001082	Short Bump Stops with Hardware - Not Shown	2
	90002067	Lower Shock Bearing Spacers - Not Shown	4
	70013497	U-Bolt- 5/8-18 x 3.13 x 5 w/2" Thread - Not Shown	4
	7xxxxxxx	C-Notch Template - Not Shown	1
R-Joint Components - (Installed in bar ends and front of wishbone)			
	70013279	Retaining Ring	4
	70013280	Wavo Wave Spring	4
	70013275	R-Joint Center Ball	4
	70013276	R-Joint Composite Center Ball Cage	4

New R-Joints will be quite stiff (75-90 in/lbs breakaway torque) until they "break in" after a few miles of use. After the break in period they will move much more freely. Because the composite bearing race contains self lubricating ingredients, no additional lubrication is needed or desired. Any additional lubrication will only serve to attract more dirt and debris to the R-Joint and actually shorten its life.



Major ComponentsIn the box

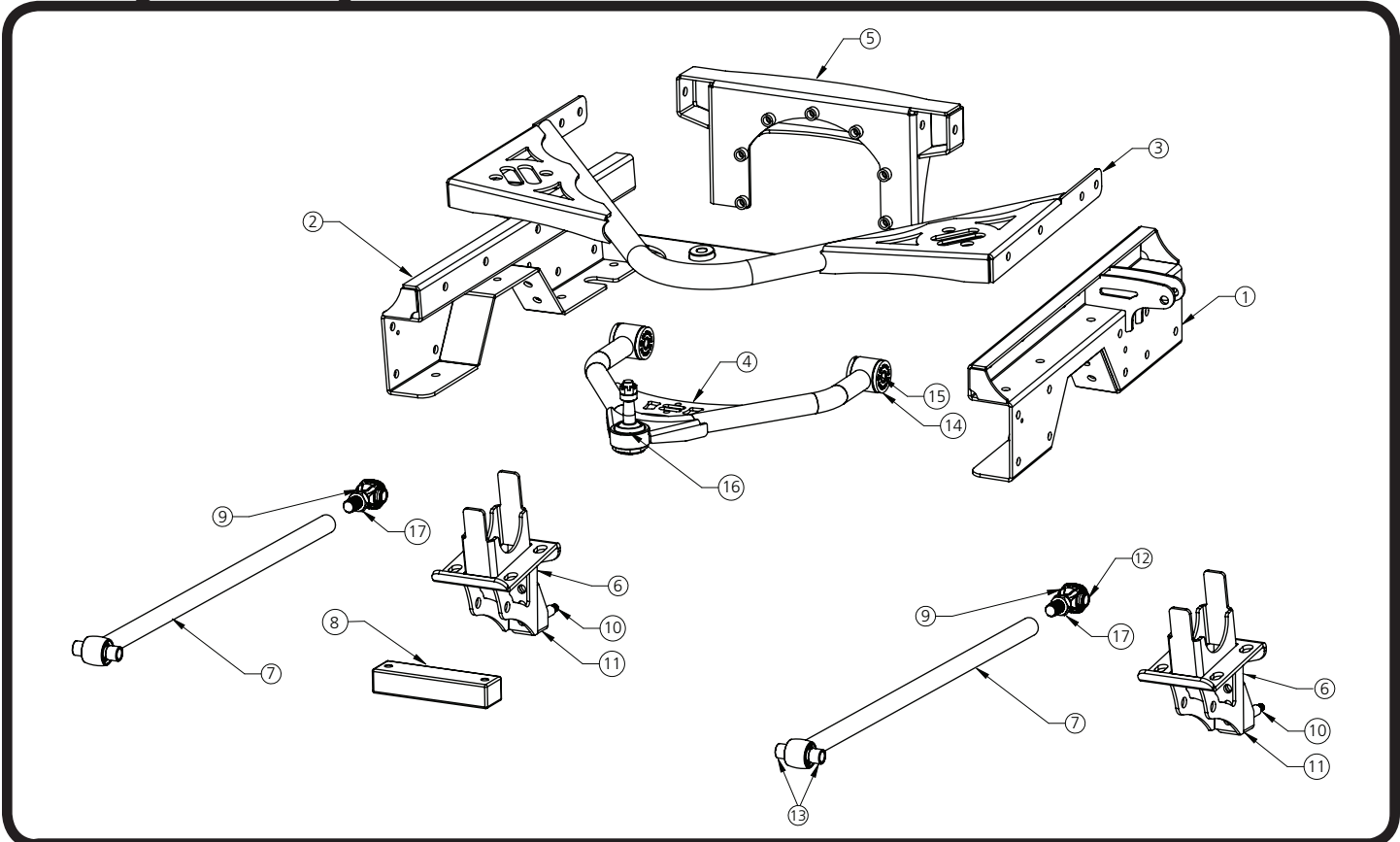

R-JOINT SPACER INSTALLATION

Install the Spacers by inserting the SMALL side of the SPACER into the Center Pivot Ball. Push them in until they bottom out and stop.

LOWER FRONT R-JOINT

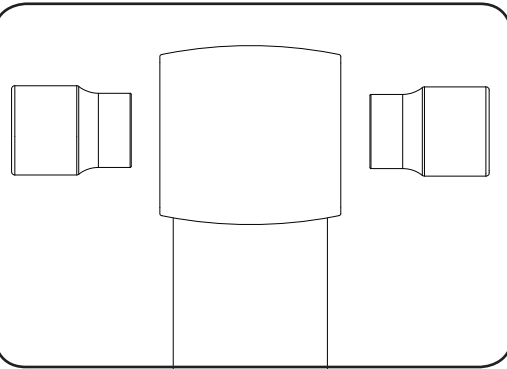

LOWER REAR R-JOINT

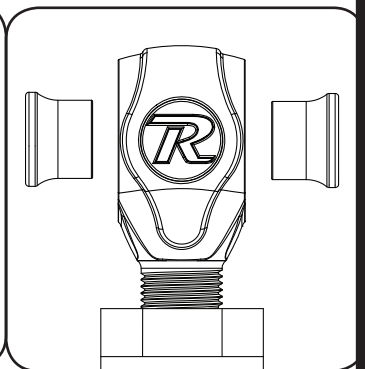

New R-Joints will be quite stiff (75-90 in/lbs breakaway torque) until they "break in" after a few miles of use. After the break in period they will move much more freely. Because the composite bearing race contains self lubricating ingredients, no additional lubrication is needed or desired. Any additional lubrication will only serve to attract more dirt and debris to the R-Joint and actually shorten its life.



Hardware ListIn the box (Kit# 99010087)

The Hardware Kit contains bags to help aid in selecting the correct hardware for the component being installed. The hardware list shows how the hardware is bagged.

QTY	Part Number	Description	QTY	Part Number	Description
"C" NOTCH MOUNTING			UPPER CONTROL ARM DIFFERENTIAL MOUNT		
36	99431008	7/16" x 1 1/2" USS Bolt	7	99315003	5/16"-18 x 2" Stud
36	99432010	7/16" USS Nylok Nut	7	99313001	5/16" SAE Flat Washer
72	99433005	7/16" SAE Flat Washer	7	99312002	5/16"-18 Nylok Nut
UPPER CONTROL ARM CROSSMEMBER			2	99312007	5/16"-18 Hex Nut
8	99431008	7/16" x 1 1/2" USS Bolt	1	90002263	Red Loctite
8	99432010	7/16" USS Nylok Nut	UPPER CONTROL ARM MOUNTING		
16	99433005	7/16" SAE Flat Washer	2	99501025	1/2"-13 x 3 1/4" Hex Bolt
AXLE BRACKET TO AXLE			2	99502009	1/2"-13 Nylok Nut
8	99622013	5/8" SAE High Nut	4	99503014	1/2" SAE Flat Washer
8	99623010	5/8" SAE Flat Washer	LOWER SHOCK MOUNT		
LOWER 4LINK BARS TO OEM MOUNT			2	99501019	1/2"-13 x 1 1/4" Hex Bolt
2	99561004	9/16"-18 x 5" GR8 Bolt	2	99501046	1/2"-13 x 1 3/4" Hex Bolt
2	99562001	9/16-18" Nylok Jam Nut	4	99502001	1/2"-13 Nylok Nut
4	99566003	9/16" SAE Flat Washer	4	99503001	1/2" SAE Flat Washer
LOWER 4LINK BARS TO AXLE MOUNT			UPPER SHOCK MOUNTING		
2	99621004	5/8"-18 x 3" Gr. 8 Bolt	2	99501064	1/2" x 2 3/4" USS Bolt Gr. 8
2	99622006	5/8"-18 Nylok Jam Nut	2	99502009	1/2" USS Nylok Nut Gr. 8
4	99623001	5/8" SAE Flat Washer	4	99503014	1/2" SAE Flat Washer Gr. 8
BRAKE LINE JUNCTION BLOCK			CARRIER BEARING MOUNT		
1	99311003	5/16"-18 x 1 1/2" Hex Bolt	2	99371062	3/8"-16 X 2 1/2" Hex Bolt
2	99313002	5/16" Flat Washer	2	99372002	3/8"-16 Nylok Nut
1	99312003	5/16"-18 Nylok Nut	4	99373003	3/8" SAE Flat Washer

Disassembly

Congratulations on your purchase of the Ridetech Rear Wishbone System. This system has been designed to give your truck excellent handling along with a lifetime of enjoyment. Some of the key features of this system: C-notches to give your suspension the travel it needs at the lowered height, 3Link setup to replace the leaf spring and provide better control of the rear axle, upper wishbone to eliminate the side-to-side movement of the differential, and the biggest feature of all, it allows the use of ShockWaves or CoilOvers.

Note: This system is designed for use with the Ridetech ShockWaves or CoilOvers. **The factory shocks and springs or the factory sway bar will not fit this 4Link.**



Disassembly

1. Raise the vehicle to a safe and comfortable working height and support it by the frame. You will need to be able to move the rear differential up and down. Use a jack under the rear axle so it can be raised and lowered as needed during the install.
2. **Remove the bed, retaining the hardware for reassembly. This kit can NOT be installed with the bed on. The bed requires minor modifications before reinstalling.**
3. Remove the leaf springs and shock absorbers. Refer to the factory service manual for proper disassembly procedures.

Getting Started.....



4. The brake line/wire clamp will need to be removed from the inside of the driver side frame rail. This will allow you to move it out of the way when cutting the frame for the c-notch.



5. Unbolt the brake line bracket from the inside of the driver side frame rail.



"C" Notch Installation

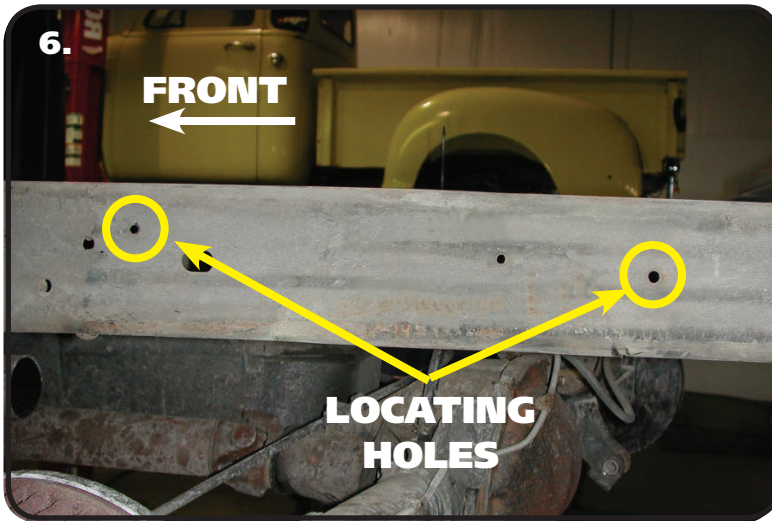

6. To allow maximum drop on this truck, the frame must be notched. The template for the notch will locate off of the 2 existing holes. **Image 6** illustrates the holes used. Use the supplied "C" Notch template to mark out the frame for cutting. Before cutting out the frame, support the frame in front of and behind the "C" Notch area. We suggest doing one side at a time.

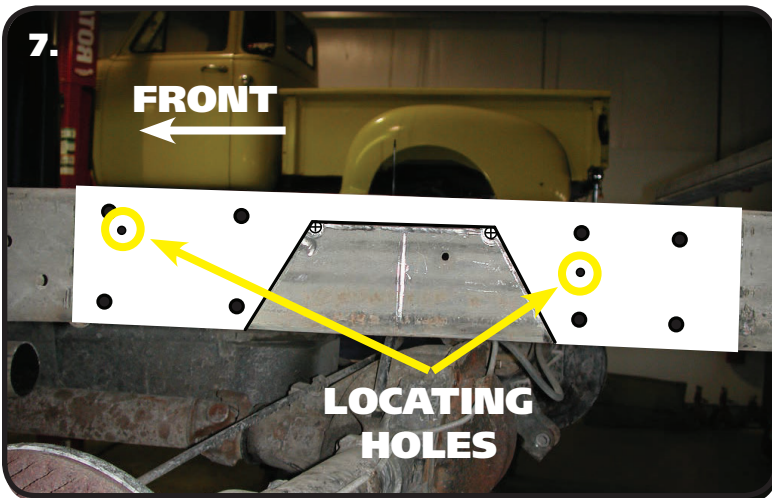

7. Use the supplied Template to mark the cut lines on the frame. Center Punch the "+" in the corners of the cut area.

NOTE: IF YOU WOULD HAPPEN TO NEED A NEW TEMPLATE, IT CAN BE FOUND ON OUR WEBSITE. GO TO www.ridetech.com, ENTER THE KIT NUMBER IN THE SEARCH BAR. THE TEMPLATE CAN THEN BE DOWNLOADED OR PRINTED.

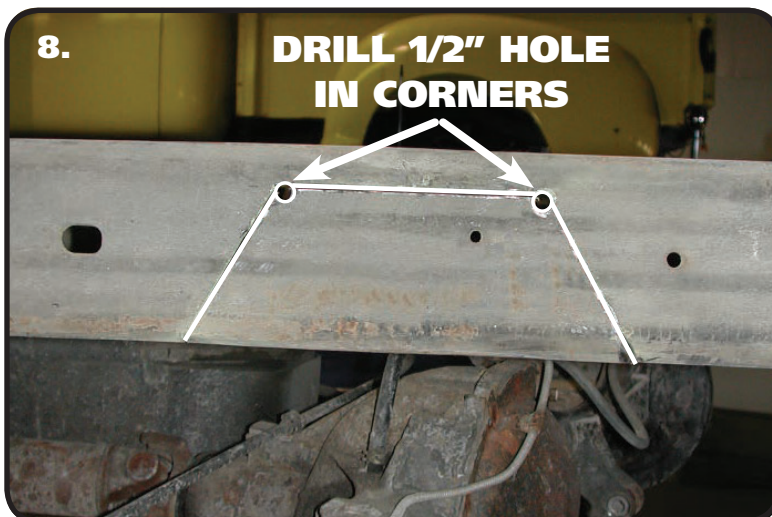

8. Drill out the two corners with a 1/2" drill bit. This will give the cut a round edge and eliminate the possibility for stress fractures. Then cut the notch with a saw-z-all, cutoff wheel, or plasma cutter. Grind all edges smooth. Check the inside of the frame for wires or lines before drilling or cutting.



"C" Notch Installation

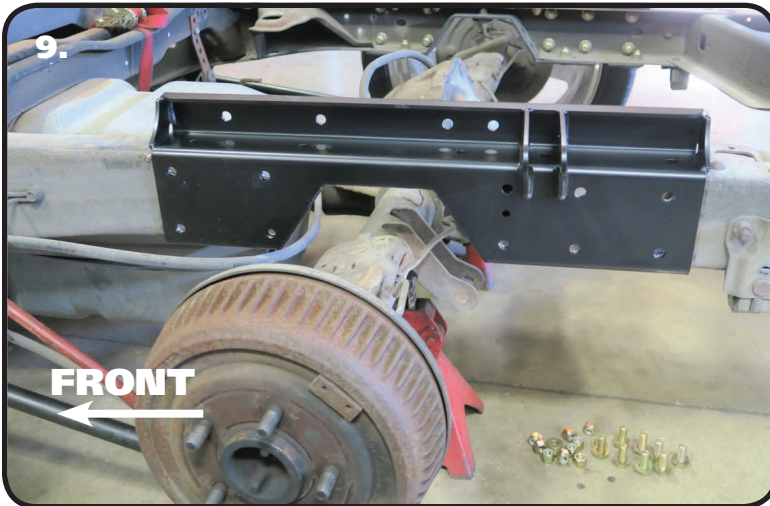

9. Slip the C-Notch over the frame rail. Use the C-Notch as a template to drill the (10) holes in the side of the frame. Use a 7/16" drill bit to drill the holes. Install a 7/16" Flat Washer on each of (10) 7/16"-14 x 1 1/4" Bolts. Insert a bolt/washer in each hole. Install a 7/16" Flat Washer and 7/16"-14 Nylok Nut on the threads of each bolt/washer and tighten. Torque the hardware to 50 ftlbs.

IT IS IMPORTANT TO TIGHTEN THE SIDE HARDWARE BEFORE DRILLING THE TOP AND BOTTOM HOLES.

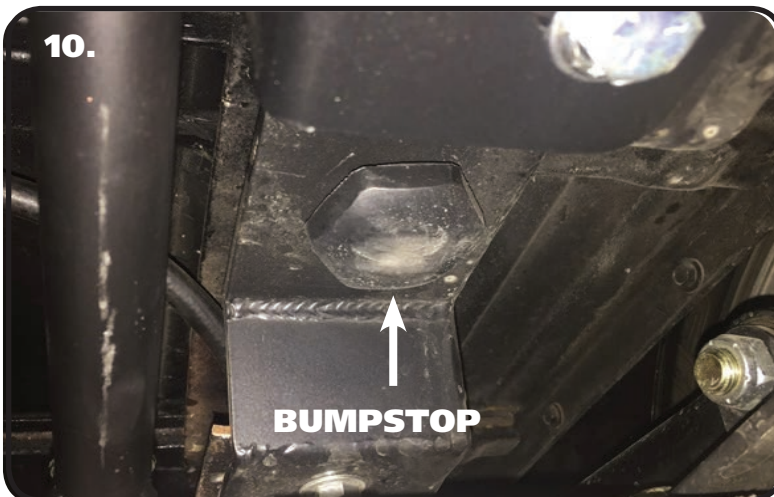

10. Bolt the Bumpstop into the C-notch using the hardware included on the bumpstop.

REPEAT STEPS 6-10 for the 2nd C-Notch.



11. Drill out the small rear locating hole to 5/16". Also, remove the nut from the 7/16" Bolt above the small hole. Install a 5/16" Flat Washer on (1) 5/16"-18 x 1 1/4" bolt and insert into the drilled hole.

STEPS 11-13 ARE DRIVER SIDE ONLY!



"C" Notch Installation



12. Slip the Brake Line Bracket over the 7/16" and 5/16" Bolts sticking through the back side of the frame. Install a Flat Washer & Nut on each and tighten.



13. Install a 5/16" Flat Washer on each of (2) 5/16" x 1 1/4" Bolts. Install the bolts/washers in the Brake Line Bracket and slip the OEM brake line bracket over the (2) bolts. Install a 5/16" Flat washer & 5/16" Nylok Nut on each bolt and tighten.

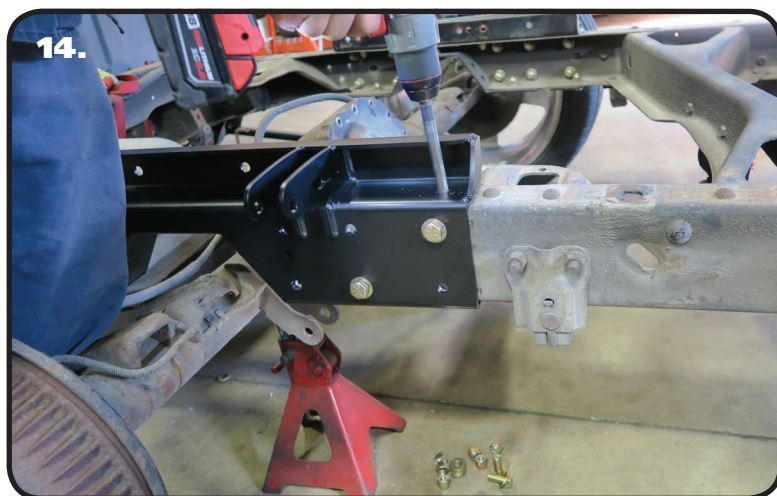

14. Use a 7/16" Drill bit to drill the remaining holes in the top and bottom of the frame. Install a 7/16" Flat Washer on the remaining 7/16" x 1 1/4" Bolts. Insert bolt/washers in the drilled holes of the c-notch. Install a 7/16" Flat washer and 7/16" Nylok Nut on the threads sticking through the c-notch/frame. Torque the hardware to 50 ftlbs.



Lower Axle Mount Installation

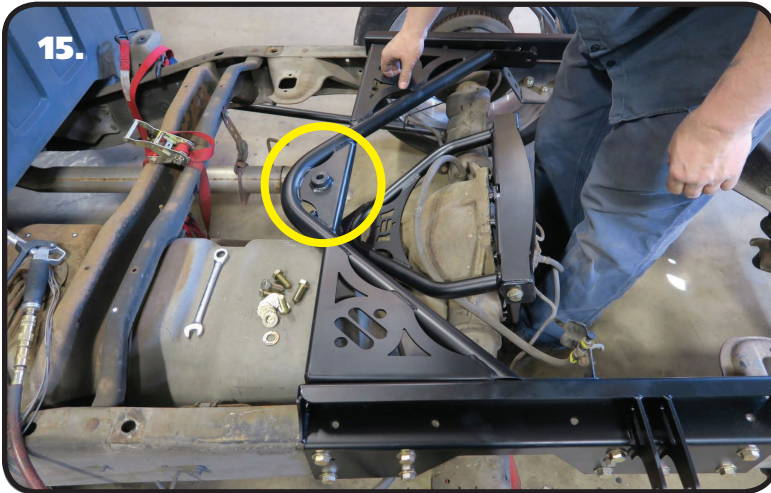

15. Insert the upper wishbone crossmember between the c-notches. The bung in the center of the cross member is tapered, the large side of the taper will need to be down. The gusset in the center will also be bent downward. Insert the cross member in position, lining up the 4 holes in the side flanges with the 4 bolt holes in each c-notch. Install a 7/16" flat washer on each of (8) 7/16"-14 x 1 1/2" bolts. Line up bolt holes and insert a bolt/washer in each one. Install a 7/16" flat washer on the threads of the bolts that is sticking through the flanges. Torque to 50 ftlbs.

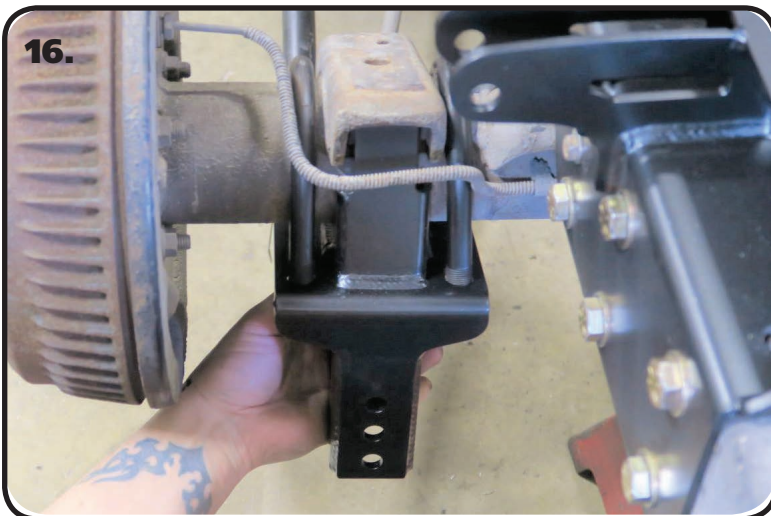

16. The Axle Mounts are the same for driver and passenger sides. Install a supplied 5/8" U-bolt on each side of the OEM leaf spring pad. Slide an Axle Mount on the U-bolts with the top tabs inserted into the leaf spring pad. Hold the mount in place and install a 5/8" Flat Washer and 5/8" High Nut on the threads of the u-bolts sticking through the axle mount. Tighten the nuts evenly in a criss-cross fashion making sure the tabs of the axle mount are touching the leaf spring pad evenly. Torque the nuts in a criss-cross fashion to 60 ftlbs. Repeat on the other side.

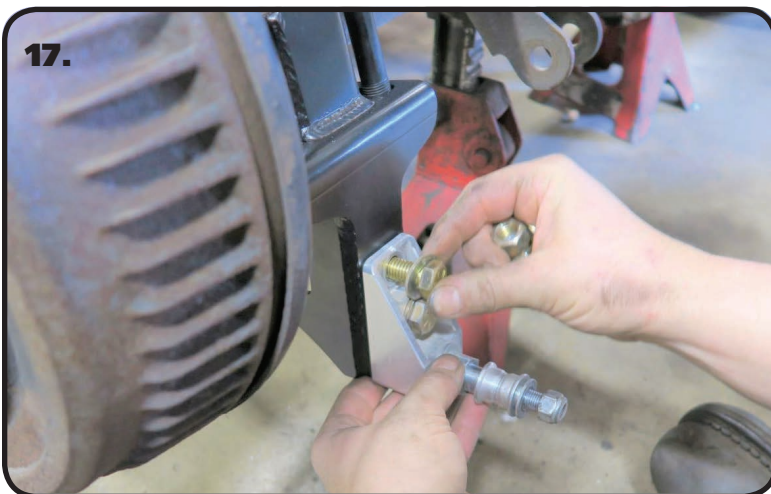

17. The Lower Shock Mount attaches with (1) 1/2"-13 x 1 1/4" Hex Bolt, (1) 1/3"-13 x 1 3/4" Hex Bolt, & (2) 1/2" Flat Washer, & (2) 1/2"-13 Nylok Nuts. The Lower Mount gets attached to the 2nd and 3rd hole up from the bottom of the Axle Mount. When the Shock Mount is installed correctly, the bottom of the Lower Shock Mount is 1/8" above the bottom of the Axle Mount. Insert the Bolts through the Aluminum Shock Mount with the 1 1/4" long bolt in the top hole, 1 3/4" in the bottom hole. Insert the bolts through the Axle Mount and install the Flat Washers & Nylok Nuts on the Threads sticking through. Repeat on both sides and torque the Bolts/Nuts to 75 ftlbs. Install a 5/8" Flat Washer onto the 5/8"-18 threads of the shock stud. Apply Red Loctite to the 5/8" threads of the stud. Thread the Shock Stud into the threaded hole of the Lower Mount. Repeat on both sides and torque the Shock Stud to 65-75 ftlbs.



Installing Lower Bars

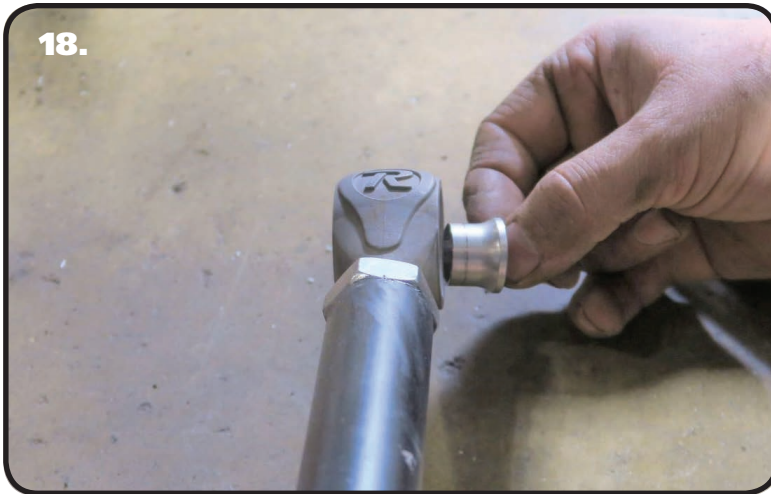

18. Insert (2) Narrow R-Joint Spacers into each side of the R-Joint with the small OD inserting into the R-Joint.



19. Insert the Rear Lower Bar R-Joint into the Lower Axle Bracket. Line up the through hole of the R-Joint with the of holes of the Axle Bracket.

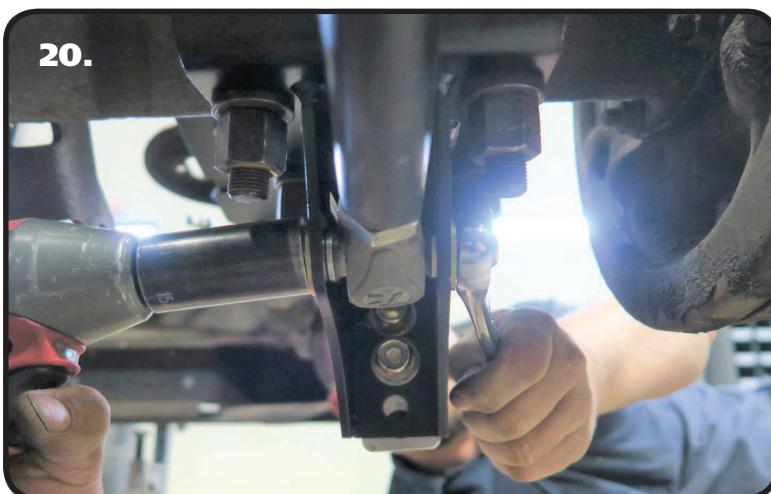

20. Install a 5/8" Flat Washer on to a 5/8"-18 x 3" Hex Bolt, insert into the lined up holes. Install a 5/8" Flat Washer followed by a 5/8"-18 Thin Jam Nylok Nut. Repeat on both sides and tighten the Bolts/Nuts enough to eliminate any gaps.



Installing Lower Bars & Wishbone Assembly

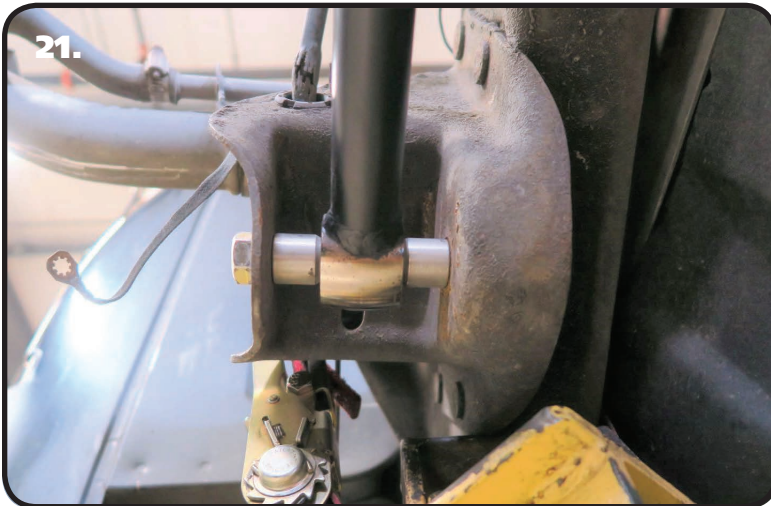

21. Insert the long R-Joint Spacers into the front of the lower bar with the small OD inserted into the R-joint. Insert the Front Lower Bar R-Joint into the Front Leaf Spring Mount. Line the through hole of the R-Joint with the holes of the leaf spring mount. Install a 9/16" Flat Washer on to a 9/16"-18 x 5" Hex Bolt, insert into the lined up holes. Install a 9/16" Flat Washer followed by a 9/16"-18 Thin Jam Nylok Nut. Repeat on both sides and tighten the Bolts/Nuts enough to eliminate any gaps.



22. Insert the rear of the Wishbone into the Axle Bracket lining up the holes. The ball joint pin needs to be pointing UP. Use **Images 22 & 23** to assist you with positioning of the ball joint pin. Install a 1/2" Flat Washer on each of (2) 1/2"-13 x 3 1/4" Bolts. Insert them into each Bracket/Bushing hole from the outside with the threads pointing to the center. Install a 1/2" Flat Washer and 1/2"-13 Nylok Nut on the threads of each bolt and tighten to 50 ftlbs.



23. **Image 23** illustrates a correctly installed upper wishbone.



Wishbone Axle Mount Installation



24. Remove the bolt that attaches the brake line junction block to the bracket. The junction block will be reattached later.

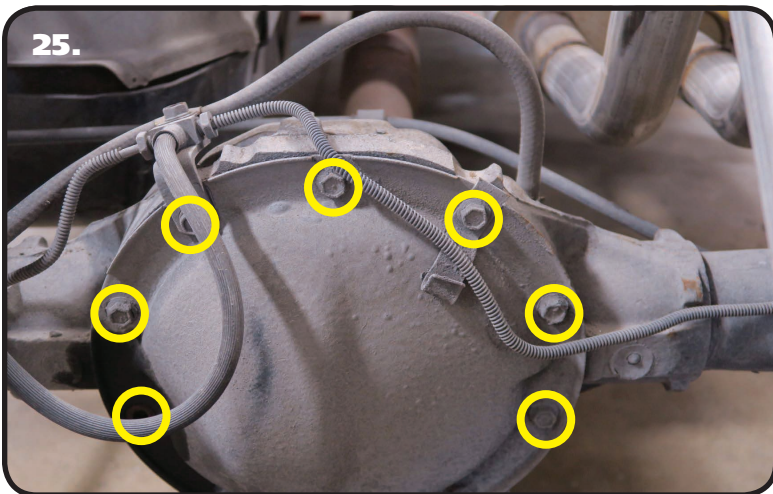

25. Remove the top (7) bolts of the differential cover leaving in the bottom (3).

IF THE DIFFERENTIAL COVER HAS A GASKET BETWEEN IT AND THE HOUSING, IT WILL NEED TO BE REMOVED AND SEALED WITH RTV SEALANT. Be sure to refill the differential with the correct gear oil before driving.

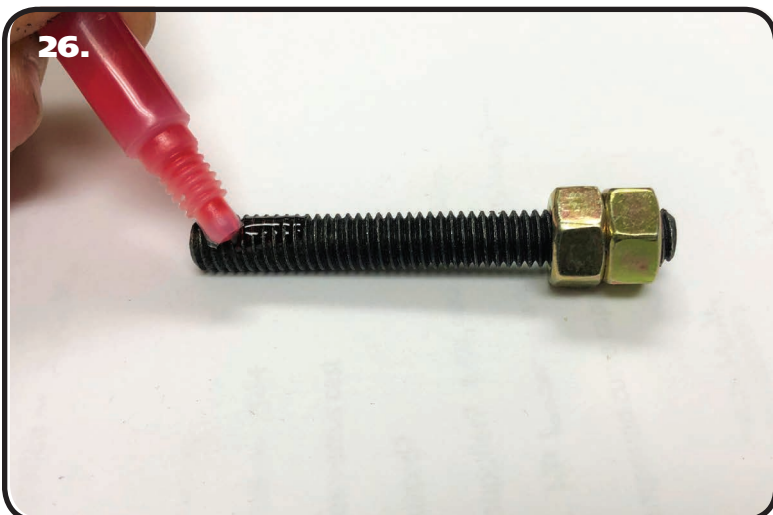

26. The 7 OEM bolts that were removed from the top of the differential cover will be replaced with 5/16"-18 x 2" Studs. These Studs and the nuts used to install them are supplied in the Hardware Bag labeled "Upper Wishbone Differential Mount". Thread the (2) 5/16"-18 Hex Nuts on one of the studs. Using (2) wrenches, tighten the nuts against each other locking them together. Apply Red Loctite to the other end of the stud.



Wishbone Axle Mount Installation



27. Thread the Stud into one of the 7 threaded holes in the axle housing. Torque the Stud to 25 ftlbs. Use 2 wrenches to unlock the nuts from each other and remove them from the stud. Repeat the process on the remaining 6 studs.



28. Position the Axle Bracket/Wishbone in place with the wishbone to the front of the truck. Line up the (7) holes in the axle bracket with the (7) threaded studs of the Differential.

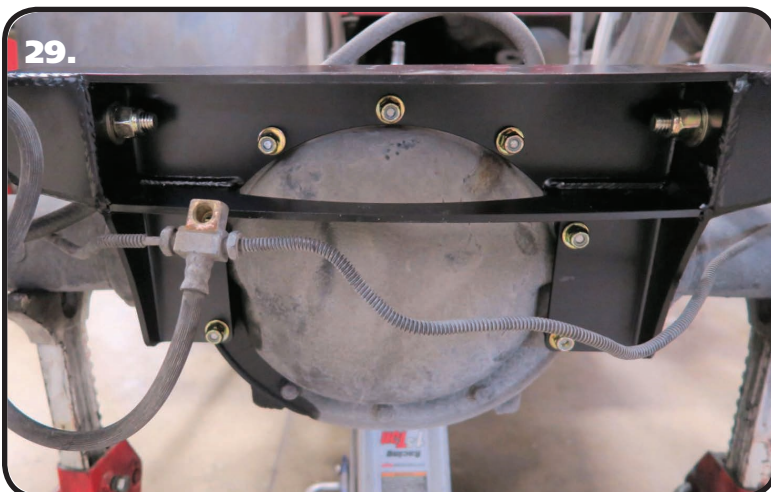

29. Using the Hardware Bag "Upper Wishbone Differential Mount", install a 5/16" Flat Washer & 5/16"-18 Nylok Nut on each of (7) 5/16" Studs. Torque to 25 ftlbs



Wishbone Installation

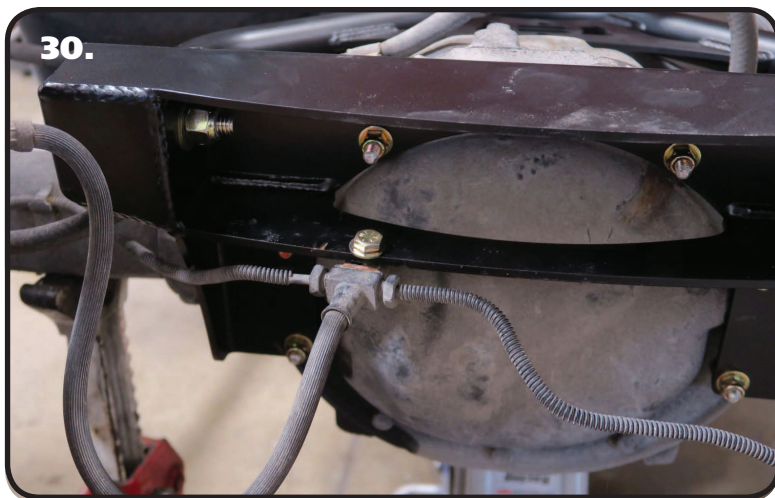

30. Using the Hardware Bag "Brake Line Junction Block", install a 5/16" Flat Washer on a 5/16"-18 x 1 1/2" Bolts. Insert the bolt/washer through the junction block and mounting hole in the differential bracket. Install a 5/16" Flat Washer & 5/16"-18 Nylok Nut on the threads of the bolt. The brake lines will need to be tweaked to get the distribution block in position. Torque the bolts to 25 ftlbs.



31. Insert the ball joint pin into the opening of the upper bridge. Push it up in the hole and install the castle nut supplied in the kit.



32. Torque the ball joint nut to 50 ftlbs. Verify if the hole in the ball joint pin aligns with any of the slots of the castle nut. Tighten the castle nut to align them. **DO NOT LOOSEN THE CASTLE NUT.** The thread the grease zerk into the ball joint and grease it.



Shockwave/Coilover Mounting



33. Insert the 1/2" ID Shock Bearing Spacer into each side of the ShockWave/CoilOver Bearing. Install a 1/2" Flat Washer on a 1/2"-13 x 2 3/4" Bolt. If installing ShockWaves, insert the top of the shock into the shock mount on the c-notch with the adjusting knob to the outside. If installing CoilOver, insert the bottom of the shock into the shock mount on the c-notch. Line up the holes and insert the bolt/washer. Install a 1/2" Flat Washer and 1/2"-13 Nylok Nut on the threads and tighten to 50 ftlbs.



34. The Shock Stud requires spacers that are .400" long (90002067). Install a 5/8" ID 90002067 spacer (**Small side towards shock body**) onto the lower Shock Stud. Slide the bottom of the Shock onto the Stud. Install a second 5/8" ID 90002067 Spacer onto the Stud (**small side towards shock**). You may need to jack the rearend up to Slide the Shock onto the Stud.

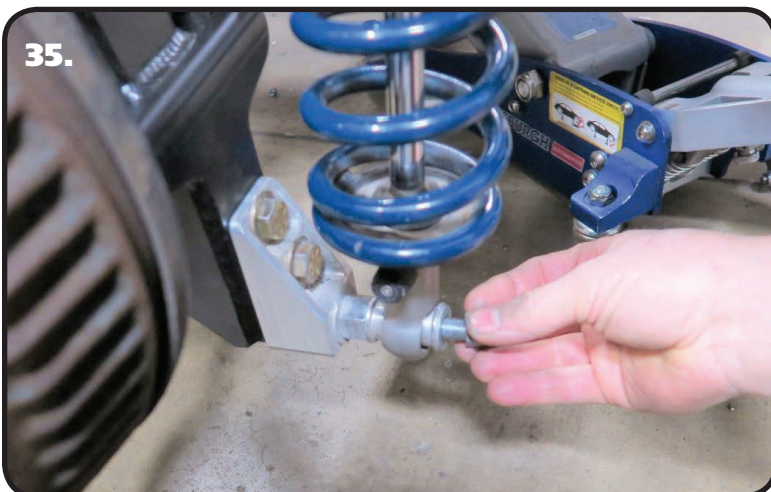

35. Install the 7/16" Flat washer and 7/16" Nylok nut. Tighten the upper and lower shock bolts. Torque the Upper Bolt to 50 ftlbs and the Lower Nut to 40 ftlbs. The designed ride height of the CoilOver/Shockwave is 14 1/2" center to center.



Carrier Bearing, Emergency Brake Cable Relocation

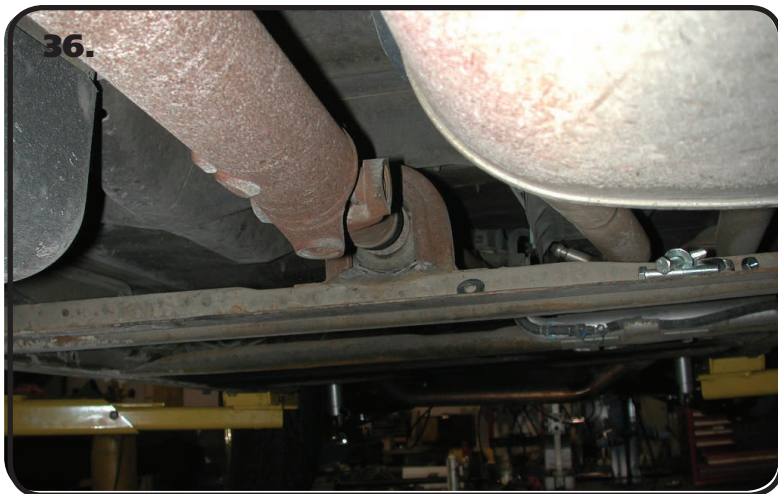

**TRUCKS WITH CARRIER BEARINGS ONLY!
IF YOUR TRUCK DOESN'T HAVE A CARRIER
BEARING, SKIP TO STEP 38**

36. The driveshaft carrier bearing will need to be relocated to optimize driveline angles at your new lower ride height. Unbolt the carrier bearing.

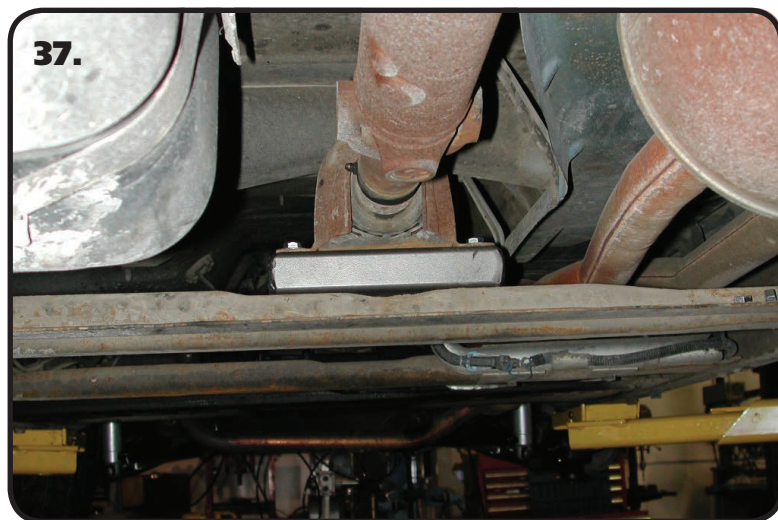

37. Install carrier bearing spacer between carrier bearing housing and cross member. Secure with 3/8" x 2 1/2" bolts, 3/8" flat washers, & 3/8" nylok nuts.



38. On some years, the emergency brake cable mounting will need to be modified for clearance. If your cable mount on the snout of the differential looks like **Image 38**, no changes will be needed. If it looks like **Image 39**, the mount will need to be flipped around.



Emergency Brake Cable Relocation, Bed Modification



39. If your emergency brake cable mount looks like **Image 39**, the mount will need to be flipped around. Start by removing the nut from the attaching bolt. Next, remove the bolt to detach the mount from the snout of the differential.



40. Use a flat bladed screwdriver to remove the mount from the emergency brake cable. Flip it around so that the bolt hole is to the rear of the truck. Use a pair of pliers to snap the mount back onto the cable.



41. Slip the mount back in position on the snout of the differential. Reattach it with the OEM hardware that was removed previously. Push the cable down as far as it will go before tightening the hardware. With it in position, tighten the hardware.



Bed Modification



42. Trimming of the bed brace that is in between the wheel wells is necessary to clear the c-notches and wishbone. We cut ours with a diegrinder and cut off wheel. **Image 42** illustrates the bed brace cut out. The cut starts 4" from the end of the brace and runs all the way across leaving 4" on the other end. It needs to be cut even with the flange that attaches the brace to the bed floor.



43. Your bed brace should look like **Image 43** after cutting.

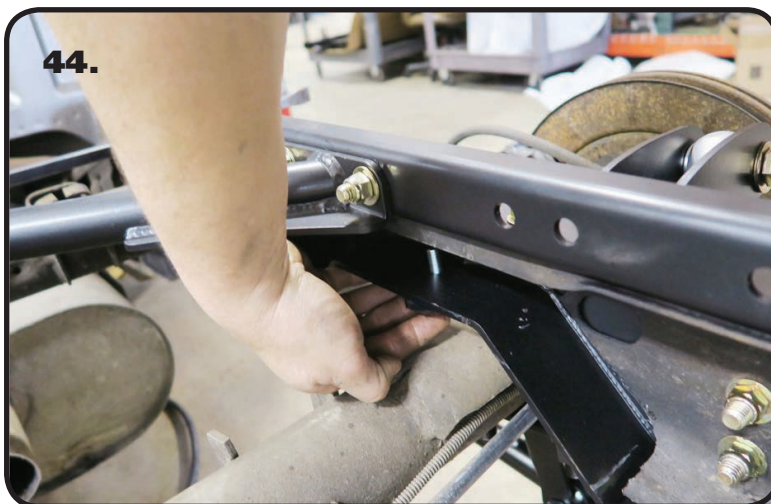

44. If you haven't already, install the bump stops into the c-notch above the axle using the 3/8" flat washer and 3/8"-16 nylok nut supplied. A bumpstop will need to be installed in each c-notch.

45. Reinstall the bed.

46. Set ride height on the truck. The ride height of the Shockwave/CoilOver is approximately 14 1/2". If you are using ShockWaves, this is done by changing the air pressure in the ShockWaves. If you are using CoilOvers, the ride height is done by using the adjuster nut for the coil spring. The coil spring on the CoilOver will have some preload in the spring to get ride height, this is normal.



Part # 21150801 - 5.2" Stroke HQ Series Shockwave

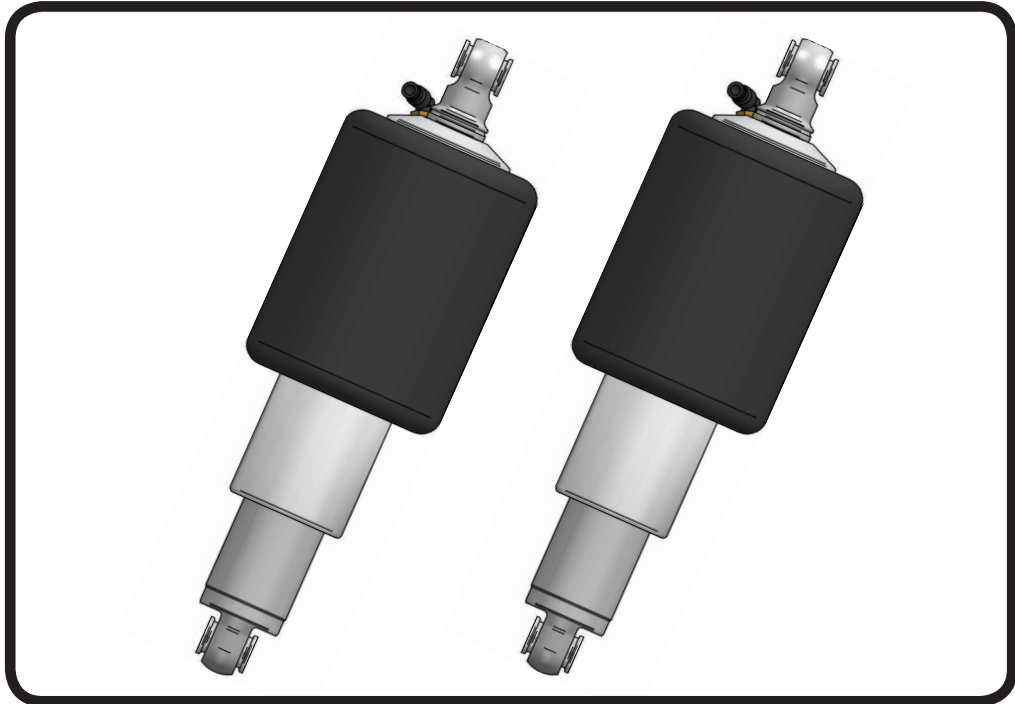

Recommended Tools

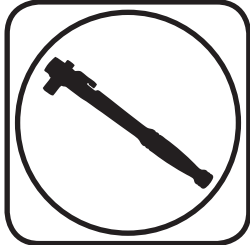

8000 Series Bellow, Eye/Eye 5.2" Shock Installation Instructions

Table of contents

Page 34..... Included components

Page 35..... Notes and Care of Your Shockwave

Page 36..... Shock Adjustment

ShockWave Dimensions:

Center of bearing to Center of bearing:	
Compressed:	11.85"
Ride Height:	14.60"
Extended:	16.42"



Major ComponentsIn the box

Item #	Part #	Description	QTY
1	24159999	5.2" Stroke HQ Series Shock	2
2	90002024	Shock Eyelet	2
3	24090899	8000 Series, 5" Diameter AirSpring	2
4	70008193	AirSpring Locking Ring (Installed on Shock)	2
5	90002044	Spacer kit - 1/2" ID and 5/8" ID	4
	90001994	5/8" ID Bearing (installed in shock and eyelet)	4
	90001995	Bearing Snap Ring (installed in shock and eyelet)	8

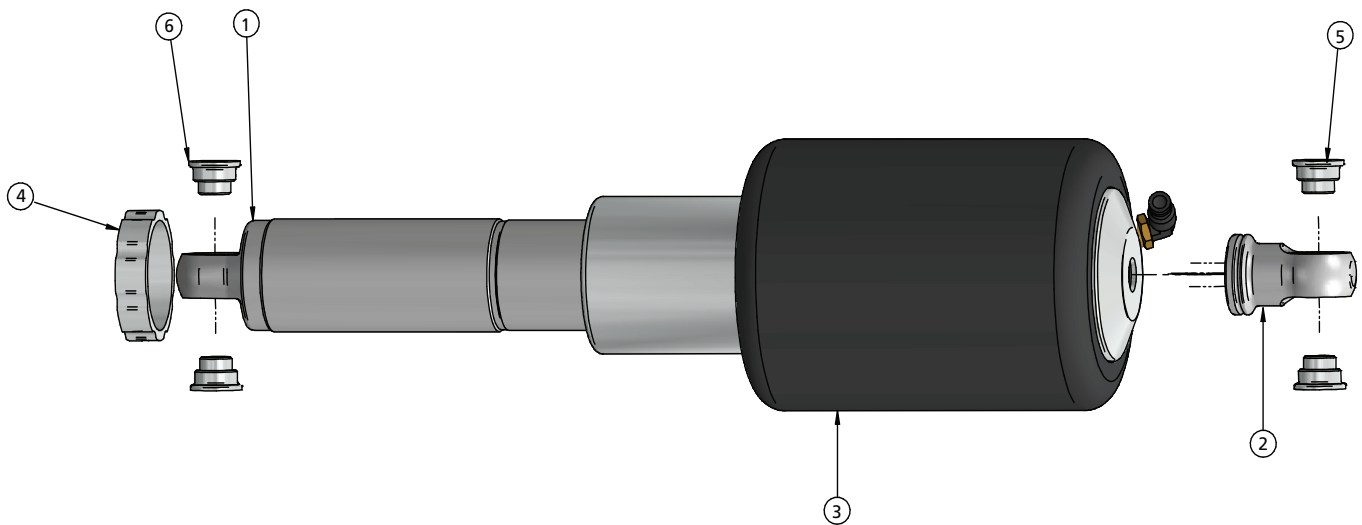

WARNING: ATTEMPTING TO REMOVE THE AIR FITTING WILL DAMAGE IT AND VOID THE WARRANTY.



Notes and Care of your Shockwaves

NOTES:

WARNING: ATTEMPTING TO REMOVE THE AIR FITTING WILL DAMAGE IT AND VOID THE WARRANTY.

You can clock the airfitting location on the ShockWave by turning the AirSpring assembly of the shock. Make sure the fitting doesn't contact the frame.

When cutting the airline, use a razor blade. The cut needs to be a clean cut and square for the airline to seal properly.

The Locking ring on the shock is **NOT** adjustable. These rings are set at the factory to optimize the AirSpring stroke with the shock stroke.

The care and feeding of your new ShockWaves

1. Although the ShockWave has an internal bumpstop, **DO NOT DRIVE THE VEHICLE DEFLATED RESTING ON THIS BUMPSTOP. DAMAGE WILL RESULT.** The internal bumpstop will be damaged, the shock bushings will be damaged, and the vehicle shock mounting points may be damaged to the point of failure. This is a non warrantable situation.
2. Do not drive the vehicle overinflated or "topped out". Over a period of time the shock valving will be damaged, possibly to the point of failure. This is a non warrantable situation! If you need to raise your vehicle higher than the ShockWave allows, you will need a longer unit.
3. The ShockWave is designed to give a great ride quality and to raise and lower the vehicle. **IT IS NOT MADE TO HOP OR JUMP!** If you want to hop or jump, hydraulics are a better choice. This abuse will result in bent piston rods, broken shock mounts, and destroyed bushings. This is a non warrantable situation.
4. Do not let the ShockWave bellows rub on anything. Failure will result. This is a non warrantable situation.
5. The ShockWave product has been field tested on numerous vehicles as well as subjected to many different stress tests to ensure that there are no leakage or durability problems. Failures have been nearly nonexistent unless abused as described above. If the Shockwave units are installed properly and are not abused, they will last many, many years. ShockWave units that are returned with broken mounts, bent piston rods, destroyed bumpstops or bushings, or abrasions on the bellows will not be warrantied.



Shock Adjustment

Shock adjustment 101- Single Adjustable

Rebound Adjustment:

How to adjust your new shocks.

The rebound adjustment knob is located on the top of the shock absorber protruding from the eyelet.

You must first begin at the ZERO setting, then set the shock to a soft setting of 20.



-Begin with the shocks adjusted to the ZERO rebound position (full stiff). Do this by rotating the rebound adjuster knob clockwise until it stops.



-Now turn the rebound adjuster knob counter clock wise 20 clicks. This sets the shock at 20. (settings 21-24 are typically too soft for street use).

Take the vehicle for a test drive.



-if you are satisfied with the ride quality, do not do anything, you are set!

-if the ride quality is too soft increase the damping effect by rotating the rebound knob clock wise 3 clicks. **CONTINUE ON NEXT PAGE.**

Take the vehicle for another test drive.



-if the vehicle is too soft increase the damping effect by rotating the rebound knob clock wise 3 additional clicks.



-If the vehicle is too stiff rotate the rebound adjustment knob counter clock wise 2 clicks and you are set!

Take the vehicle for another test drive and repeat the above steps until the ride quality is satisfactory.

Note:

One end of the vehicle will likely reach the desired setting before the other end. If this happens stop adjusting the satisfied end and keep adjusting the unsatisfied end until the overall ride quality is satisfactory.

STILL HAVE QUESTIONS?

Tech line hours

Monday - Friday

8AM - 6PM (EST) 812-482-2932