

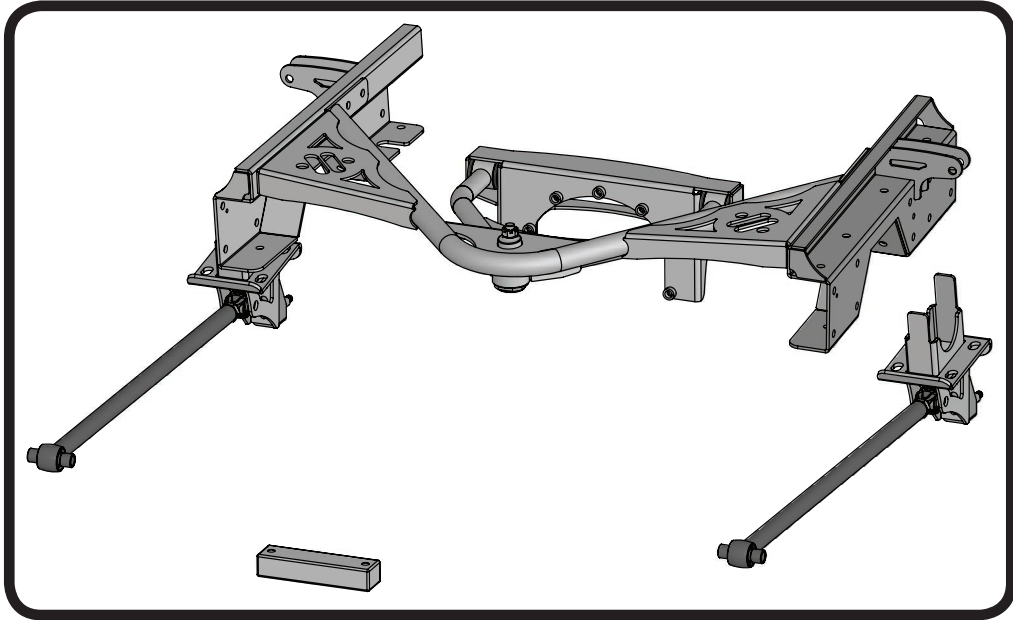

Part # 11377195

1988-1998 C1500 14 Bolt Rear Bolt-On Wishbone Suspension System



Recommended Tools

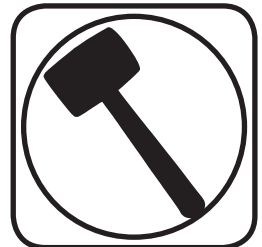
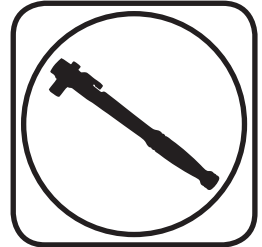

1988-1998 C1500 14 Bolt Rear Suspension Installation Instructions

Table of contents

Page 2-3.....	Included Components
Page 4.....	Hardware List & Disassembly
Page 5.....	Disassembly & Getting Started
Page 6-8.....	C-Notch Installation
Page 9.....	Lower Axle Mount Installation
Page 10.....	Installing Lower Bars
Page 11.....	Installing Lower Bars & Wishbone Assembly
Page 12-13.....	Wishbone Axle Mount Installation
Page 14.....	Wishbone Installation
Page 15.....	Shockwave/CoilOver Mounting
Page 16.....	Carrier Bearing Mount
Page 17.....	E-Brake Cable Relocation
Page 18.....	Bed Modification





Major ComponentsIn the box

Item #	Part #	Description	QTY
1	90001271	Driver C-Notch	1
2	90001272	Passenger C-Notch	1
3	90001273	Rear Upper Control Arm Mount Crossmember	1
4	90001274	Rear Upper Wishbone	1
5	90001330	Rear Upper Control Arm Differential Mount	1
6	90001331	Lower Axle Bracket	2
7	90001277	Lower Bars - Set to 31 3/4"	2
8	90001329	Carrier Bearing Spacer - used on carrier bearing equipped trucks	1
9	70013364	RH R-Joint Threaded Housing	2
10	90001617	5/8" Shock Stud	2
11	90001624	Aluminum Lower Shock Mount	2
12	70013334	R-Joint Spacers - rear lower bar	4
13	70013769	R-Joint Spacer - Lower Bars - Front	4
14	70010759	Delrin Bushings - installed in upper control arm	4
15	90000549	Delrin Bushing Inner Sleeves - installed in upper control arm	2
16	90000895	Ball Joint - Upper Wishbone	1
17	99752004	3/4"-16 Jam Nut - Installed on Lower Bars	2
	90001082	Short Bump Stops with Hardware - Not Shown	2
	90002067	Lower Shock Bearing Spacers - Not Shown	4
	99566007	U-Bolt- 5/8-18 x 3.13 x 5 w/2" Thread - Not Shown	4
	70014580	Driver C-Notch Template - Not Shown	1
	70014581	Passenger C-Notch Template - Not Shown	1
R-Joint Components - (Installed in bar ends and front of wishbone)			
	70013279	Retaining Ring	4
	70013280	Wavo Wave Spring	4
	70013275	R-Joint Center Ball	4
	70013276	R-Joint Composite Center Ball Cage	4

New R-Joints will be quite stiff (75-90 in/lbs breakaway torque) until they "break in" after a few miles of use. After the break in period they will move much more freely. Because the composite bearing race contains self lubricating ingredients, no additional lubrication is needed or desired. Any additional lubrication will only serve to attract more dirt and debris to the R-Joint and actually shorten its life.



Major ComponentsIn the box

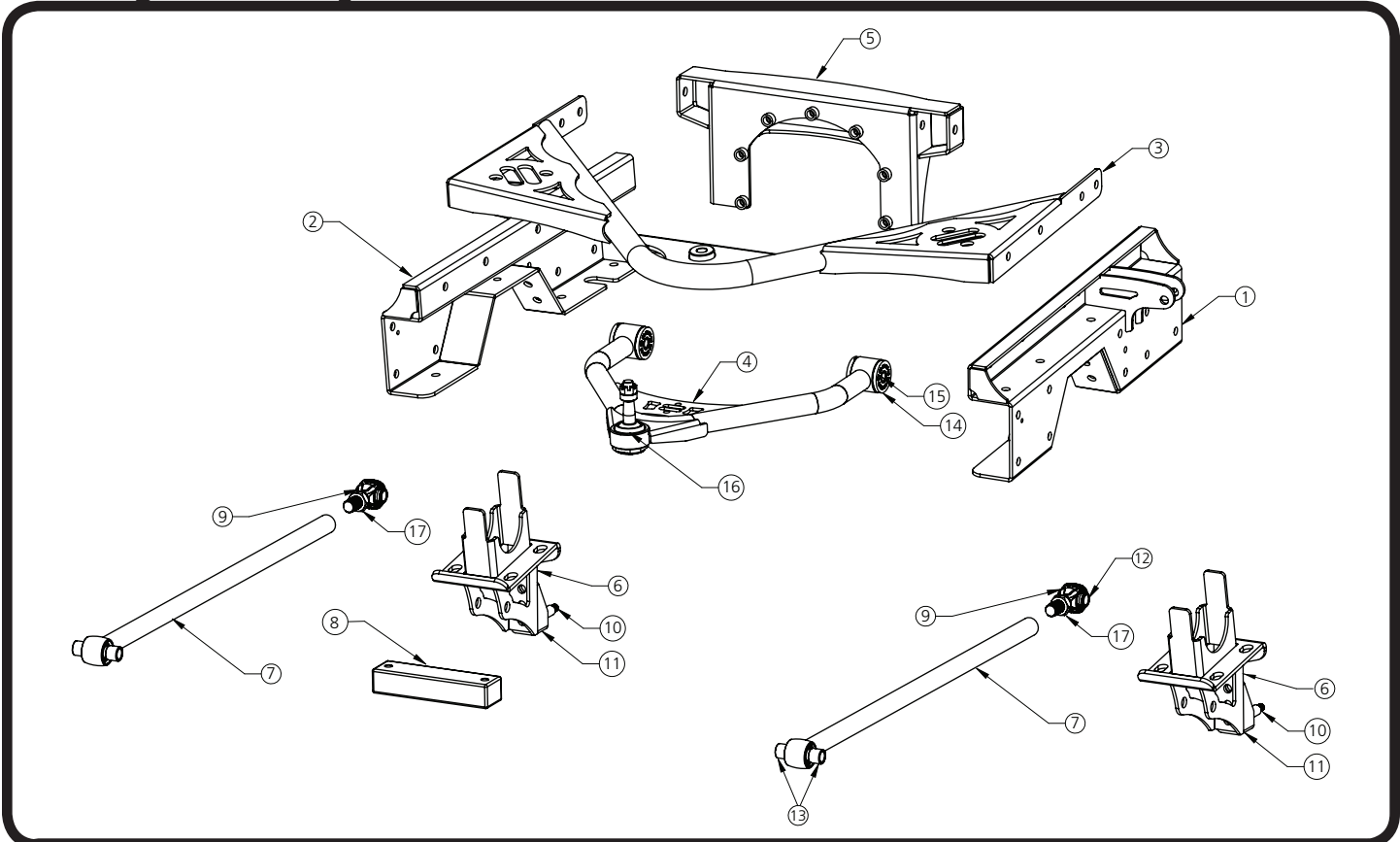

R-JOINT SPACER INSTALLATION

Install the Spacers by inserting the SMALL side of the SPACER into the Center Pivot Ball. Push them in until they bottom out and stop.

LOWER FRONT R-JOINT

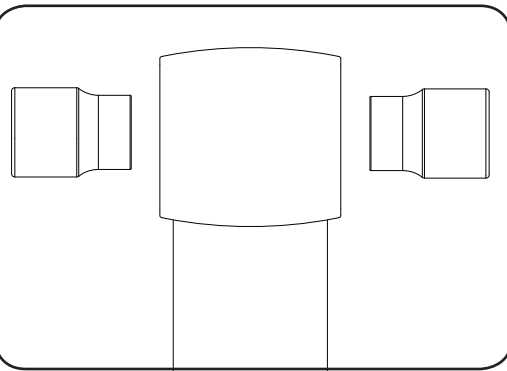

LOWER REAR R-JOINT

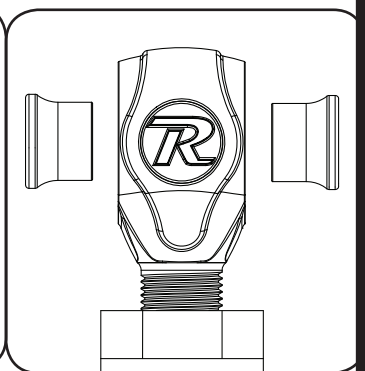

New R-Joints will be quite stiff (75-90 in/lbs breakaway torque) until they "break in" after a few miles of use. After the break in period they will move much more freely. Because the composite bearing race contains self lubricating ingredients, no additional lubrication is needed or desired. Any additional lubrication will only serve to attract more dirt and debris to the R-Joint and actually shorten its life.



Hardware ListIn the box (Kit# 99010087)

The Hardware Kit contains bags to help aid in selecting the correct hardware for the component being installed. The hardware list shows how the hardware is bagged.

QTY	Part Number	Description	QTY	Part Number	Description
"C" NOTCH MOUNTING			UPPER CONTROL ARM DIFFERENTIAL MOUNT		
36	99431008	7/16" x 1 1/2" USS Bolt	7	99315003	5/16"-18 x 2" Stud
36	99432010	7/16" USS Nylok Nut	7	99313001	5/16" SAE Flat Washer
72	99433005	7/16" SAE Flat Washer	7	99312002	5/16" 18 Nylok Nut
UPPER CONTROL ARM CROSSMEMBER			2	99312007	5/16"-18 Hex Nut
8	99431008	7/16" x 1 1/2" USS Bolt	1	90002263	Red Loctite
8	99432010	7/16" USS Nylok Nut	UPPER CONTROL ARM MOUNTING		
16	99433005	7/16" SAE Flat Washer	2	99501025	1/2"-13 x 3 1/4" Hex Bolt
AXLE BRACKET TO AXLE			2	99502009	1/2"-13 Nylok Nut
8	99622013	5/8" SAE High Nut	4	99503014	1/2" SAE Flat Washer
8	99623010	5/8" SAE Flat Washer	LOWER SHOCK MOUNT		
LOWER 4LINK BARS TO OEM MOUNT			2	99501019	1/2"-13 x 1 1/4" Hex Bolt
2	99561004	9/16"-18 x 5" GR8 Bolt	2	99501046	1/2"-13 x 1 3/4" Hex Bolt
2	99562001	9/16-18" Nylok Jam Nut	4	99502001	1/2"-13 Nylok Nut
4	99566003	9/16" SAE Flat Washer	4	99503001	1/2" SAE Flat Washer
LOWER 4LINK BARS TO AXLE MOUNT			UPPER SHOCK MOUNTING		
2	99621004	5/8"-18 x 3" Gr. 8 Bolt	2	99501064	1/2" x 2 3/4" USS Bolt Gr. 8
2	99622006	5/8"-18 Nylok Jam Nut	2	99502009	1/2" USS Nylok Nut Gr. 8
4	99623001	5/8" SAE Flat Washer	4	99503014	1/2" SAE Flat Washer Gr. 8
BRAKE LINE JUNCTION BLOCK			CARRIER BEARING MOUNT		
1	99311003	5/16"-18 x 1 1/2" Hex Bolt	2	99371062	3/8"-16 X 2 1/2" Hex Bolt
2	99313002	5/16" Flat Washer	2	99372002	3/8"-16 Nylok Nut
1	99312003	5/16"-18 Nylok Nut	4	99373003	3/8" SAE Flat Washer

Hardware ListIn the box (Kit# 99010090)

THIS HARDWARE KIT CANTAINS HARDWARE FOR THE 14 BOLT DIFFERENTIAL WISHBONE MOUNT.

QTY	Part Number	Description	QTY	Part Number	Description
UPPER CONTROL ARM DIFFERENTIAL MOUNT			UPPER CONTROL ARM DIFFERENTIAL MOUNT		
9	99085001	M8-1.25 x 50mm Stud	9	9908300	M8 Flat Washer
2	99082001	M8-1.25 Hex Nut	9	99082002	M8-1.25 Nylok Nut



Disassembly

Congratulations on your purchase of the Ridetech Rear Wishbone System. This system has been designed to give your truck excellent handling along with a lifetime of enjoyment. Some of the key features of this system: C-notches to give your suspension the travel it needs at the lowered height, 3Link setup to replace the leaf spring and provide better control of the rear axle, upper wishbone to eliminate the side-to-side movement of the differential, and the biggest feature of all, it allows the use of ShockWaves or CoilOvers.

Note: This system is designed for use with the Ridetech ShockWaves or CoilOvers. **The factory shocks and springs or the factory sway bar will not fit this 4Link.**

1. Raise the vehicle to a safe and comfortable working height and support it by the frame. You will need to be able to move the rear differential up and down. Use a jack under the rear axle so it can be raised and lowered as needed during the install.
2. **Remove the bed, retaining the hardware for reassembly. This kit can NOT be installed with the bed on. The bed requires minor modifications before reinstalling.**
3. Remove the leaf springs and shock absorbers. Refer to the factory service manual for proper disassembly procedures.

Getting Started.....



4. The brake line/wire clamp will need to be removed from the inside of the driver side frame rail. This will allow you to move it out of the way when cutting the frame for the c-notch.



5. Unbolt the brake line bracket from the inside of the driver side frame rail.



"C" Notch Installation

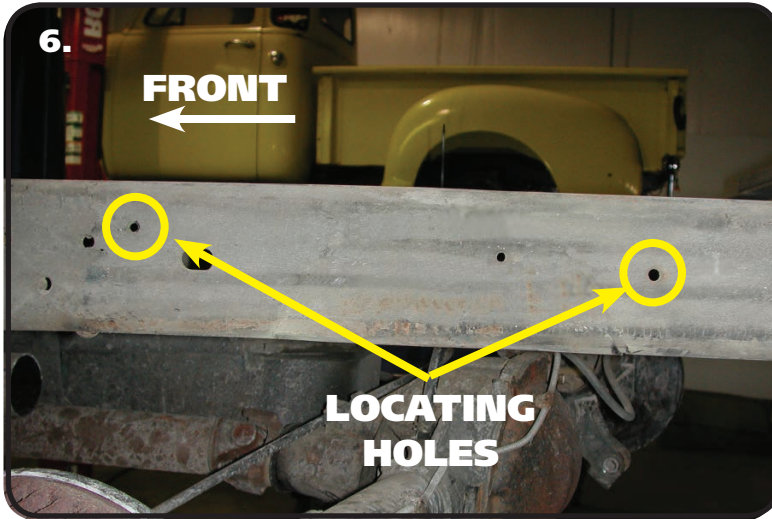

6. To allow maximum drop on this truck, the frame must be notched. The template for the notch will locate off of the 2 existing holes. **Image 6** illustrates the holes used. Use the supplied "C" Notch template to mark out the frame for cutting. Before cutting out the frame, support the frame in front of and behind the "C" Notch area. We suggest doing one side at a time.

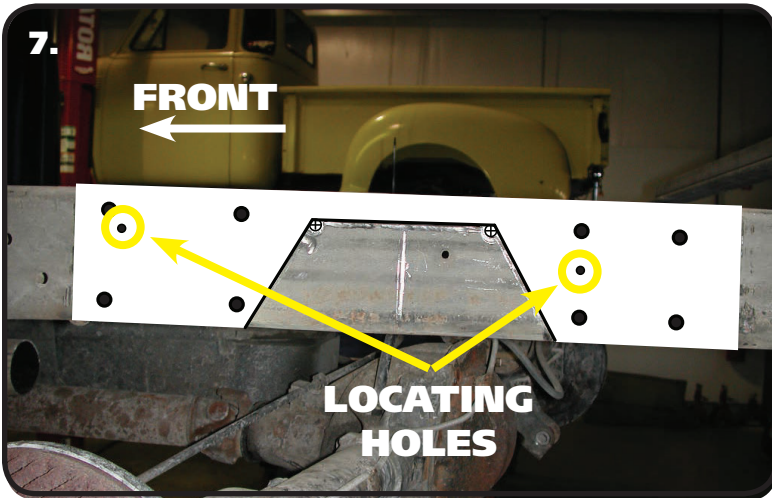

7. Use the supplied Template to mark the cut lines on the frame. Center Punch the "+" in the corners of the cut area.

NOTE: IF YOU WOULD HAPPEN TO NEED A NEW TEMPLATE, IT CAN BE FOUND ON OUR WEBSITE. GO TO www.ridetech.com, ENTER THE KIT NUMBER IN THE SEARCH BAR. THE TEMPLATE CAN THEN BE DOWNLOADED OR PRINTED.

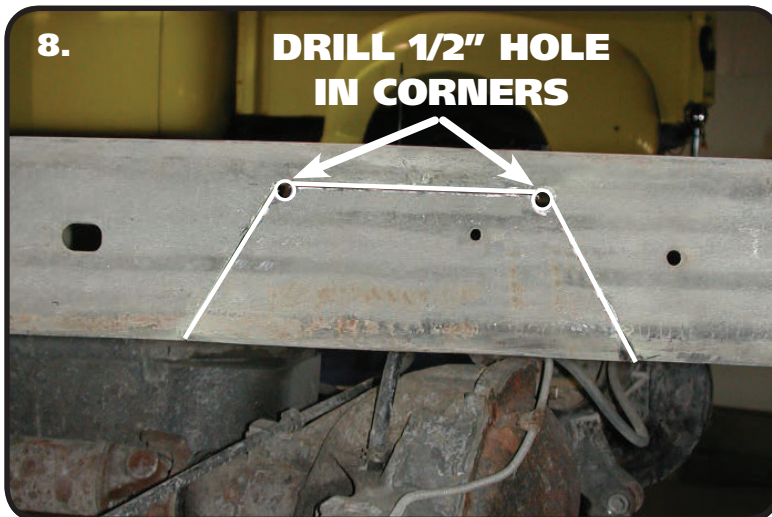

8. Drill out the two corners with a 1/2" drill bit. This will give the cut a round edge and eliminate the possibility for stress fractures. Then cut the notch with a saw-z-all, cutoff wheel, or plasma cutter. Grind all edges smooth. Check the inside of the frame for wires or lines before drilling or cutting.



"C" Notch Installation

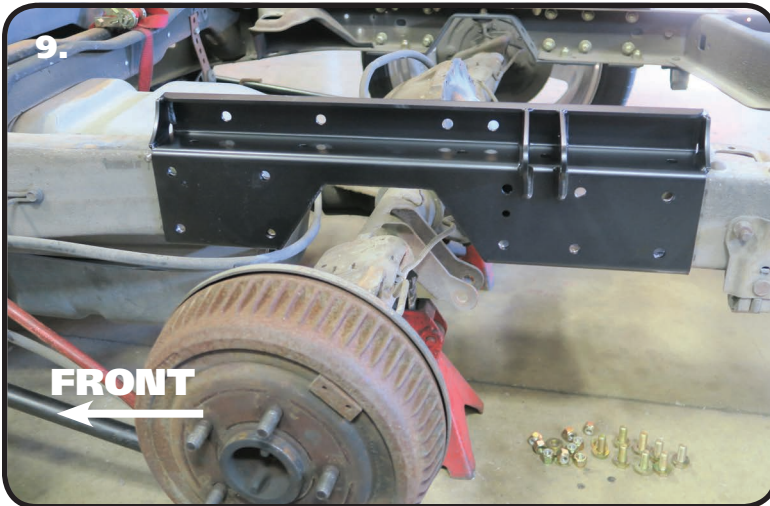

9. Slip the C-Notch over the frame rail. Use the C-Notch as a template to drill the (10) holes in the side of the frame. Use a 7/16" drill bit to drill the holes. Install a 7/16" Flat Washer on each of (10) 7/16"-14 x 1 1/4" Bolts. Insert a bolt/washer in each hole. Install a 7/16" Flat Washer and 7/16"-14 Nylok Nut on the threads of each bolt/washer and tighten. Torque the hardware to 50 ftlbs.

IT IS IMPORTANT TO TIGHTEN THE SIDE HARDWARE BEFORE DRILLING THE TOP AND BOTTOM HOLES.

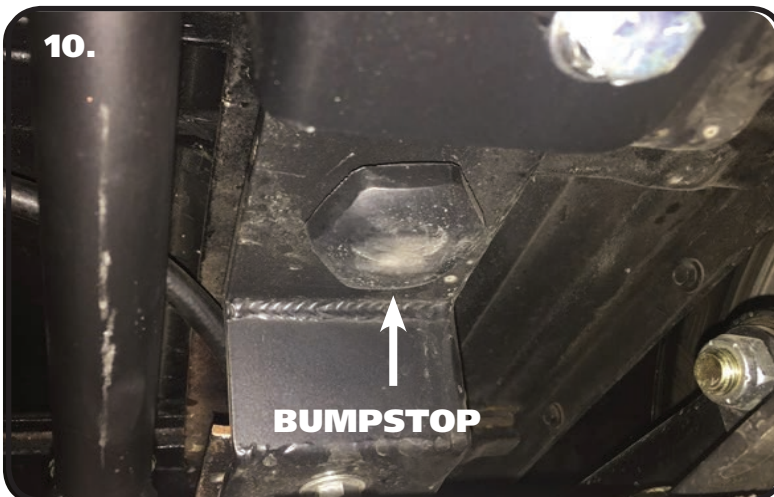

10. Bolt the Bumpstop into the C-notch using the hardware included on the bumpstop.

REPEAT STEPS 6-10 for the 2nd C-Notch.



11. Drill out the small rear locating hole to 5/16". Also, remove the nut from the 7/16" Bolt above the small hole. Install a 5/16" Flat Washer on (1) 5/16"-18 x 1 1/4" bolt and insert into the drilled hole.

STEPS 11-13 ARE DRIVER SIDE ONLY!



"C" Notch Installation



12. Slip the Brake Line Bracket over the 7/16" and 5/16" Bolts sticking through the back side of the frame. Install a Flat Washer & Nut on each and tighten.



13. Install a 5/16" Flat Washer on each of (2) 5/16" x 1 1/4" Bolts. Install the bolts/washers in the Brake Line Bracket and slip the OEM brake line bracket over the (2) bolts. Install a 5/16" Flat washer & 5/16" Nylok Nut on each bolt and tighten.

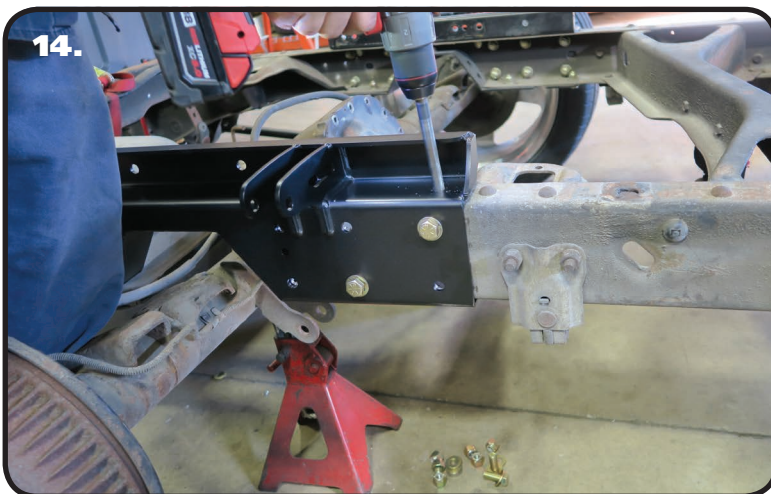

14. Use a 7/16" Drill bit to drill the remaining holes in the top and bottom of the frame. Install a 7/16" Flat Washer on the remaining 7/16" x 1 1/4" Bolts. Insert bolt/washers in the drilled holes of the c-notch. Install a 7/16" Flat washer and 7/16" Nylok Nut on the threads sticking through the c-notch/frame.



Lower Axle Mount Installation

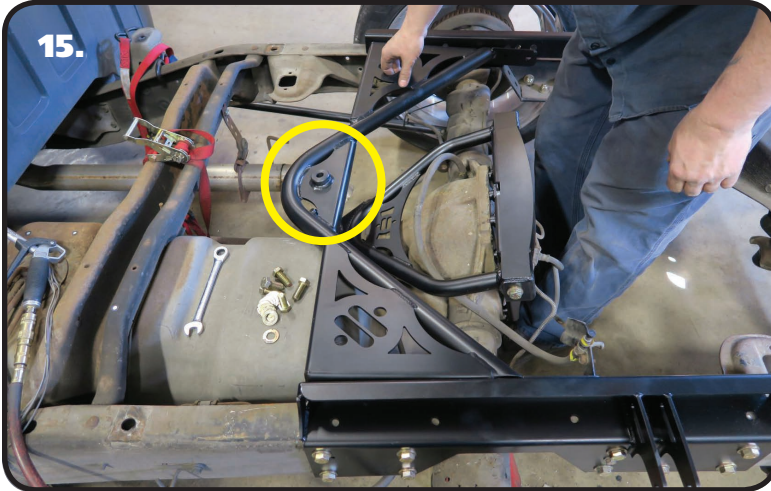

15. Insert the upper wishbone crossmember between the c-notches. The bung in the center of the cross member is tapered, the large side of the taper will need to be down. The gusset in the center will also be bent downward. Insert the cross member in position, lining up the 4 holes in the side flanges with the 4 bolt holes in each c-notch. Install a 7/16" flat washer on each of (8) 7/16"-14 x 1 1/2" bolts. Line up bolt holes and insert a bolt/washer in each one. Install a 7/16" flat washer on the threads of the bolts that is sticking through the flanges. Torque to 50 ftlbs.

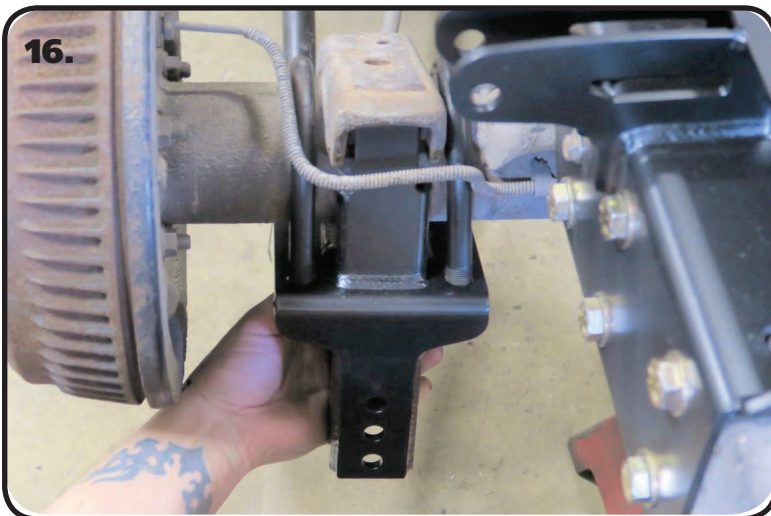

16. The Axle Mounts are the same for driver and passenger sides. Install a supplied 5/8" U-bolt on each side of the OEM leaf spring pad. Slide an Axle Mount on the U-bolts with the top tabs inserted into the leaf spring pad. Hold the mount in place and install a 5/8" Flat Washer and 5/8" High Nut on the threads of the u-bolts sticking through the axle mount. Tighten the nuts evenly in a criss-cross fashion making sure the tabs of the axle mount are touching the leaf spring pad evenly. Torque the nuts in a criss-cross fashion to 60 ftlbs. Repeat on the other side.



17. The Lower Shock Mount attaches with (1) 1/2"-13 x 1 1/4" Hex Bolt, (1) 1/3"-13 x 1 3/4" Hex Bolt, & (2) 1/2" Flat Washer, & (2) 1/2"-13 Nylok Nuts. The Lower Mount gets attached to the 2nd and 3rd hole up from the bottom of the Axle Mount. When the Shock Mount is installed correctly, the bottom of the Lower Shock Mount is 1/8" above the bottom of the Axle Mount. Insert the Bolts through the Aluminum Shock Mount with the 1 1/4" long bolt in the top hole, 1 3/4" in the bottom hole. Insert the bolts through the Axle Mount and install the Flat Washers & Nylok Nuts on the Threads sticking through. Repeat on both sides and torque the Bolts/Nuts to 75 ftlbs. Install a 5/8" Flat Washer onto the 5/8"-18 threads of the shock stud. Apply Red Loctite to the 5/8" threads of the stud. Thread the Shock Stud into the threaded hole of the Lower Mount. Repeat on both sides and torque the Shock Stud to 65-75 ftlbs.



Installing Lower Bars

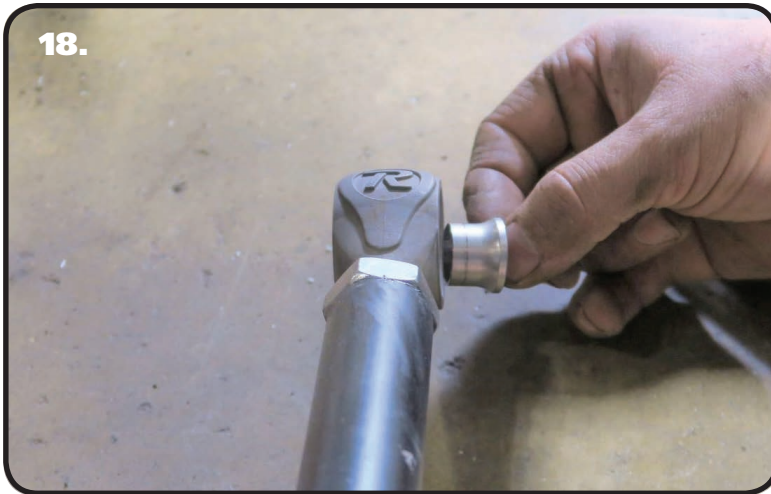

18. Insert (2) Narrow R-Joint Spacers into each side of the R-Joint with the small OD inserting into the R-Joint.

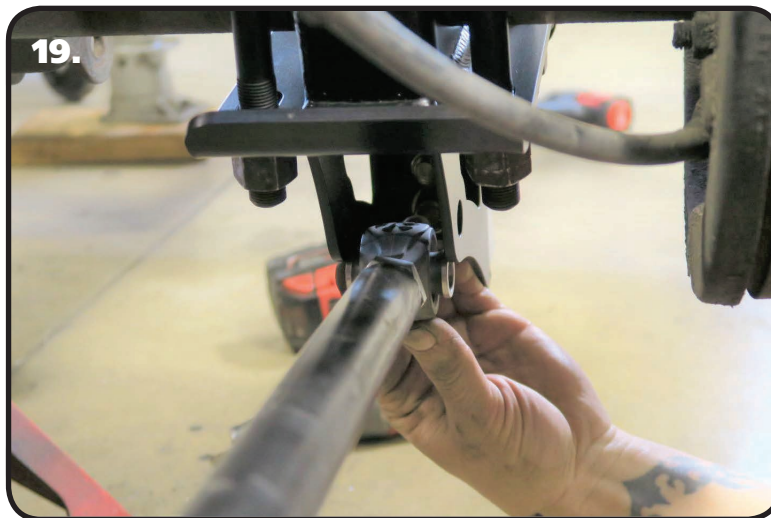

19. Insert the Rear Lower Bar R-Joint into the Lower Axle Bracket. Line up the through hole of the R-Joint with the of holes of the Axle Bracket.

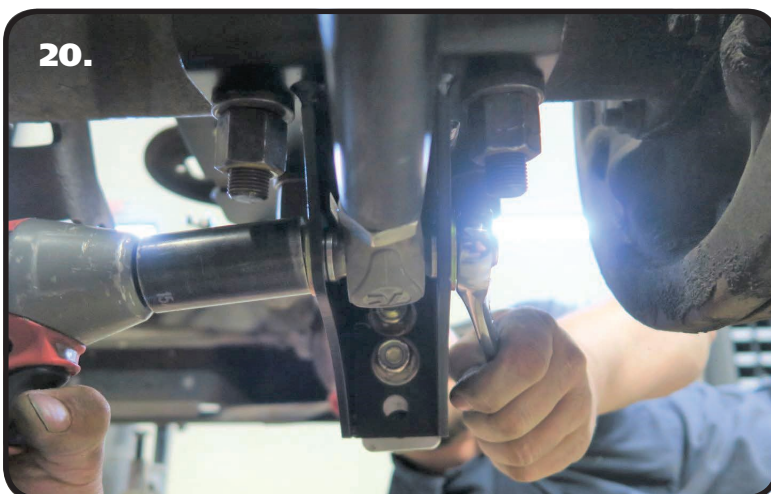

20. Install a 5/8" Flat Washer on to a 5/8"-18 x 3" Hex Bolt, insert into the lined up holes. Install a 5/8" Flat Washer followed by a 5/8"-18 Thin Jam Nylok Nut. Repeat on both sides and tighten the Bolts/Nuts enough to eliminate any gaps.



Installing Lower Bars & Wishbone Assembly

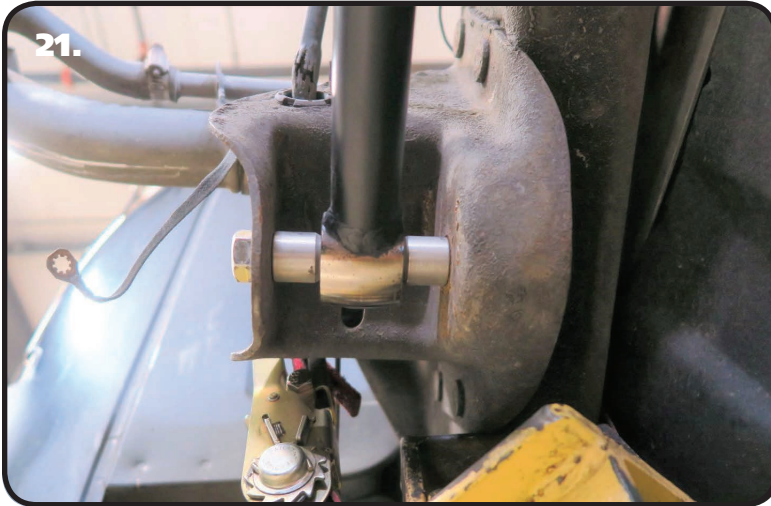

21. Insert the long R-Joint Spacers into the front of the lower bar with the small OD inserted into the R-joint. Insert the Front Lower Bar R-Joint into the Front Leaf Spring Mount. Line the through hole of the R-Joint with the holes of the leaf spring mount. Install a 9/16" Flat Washer on to a 9/16"-18 x 5" Hex Bolt, insert into the lined up holes. Install a 9/16" Flat Washer followed by a 9/16"-18 Thin Jam Nylok Nut. Repeat on both sides and tighten the Bolts/Nuts enough to eliminate any gaps.



22. Insert the rear of the Wishbone into the Axle Bracket lining up the holes. The ball joint pin needs to be pointing UP. Use **Images 22 & 23** to assist you with positioning of the ball joint pin. Install a 1/2" Flat Washer on each of (2) 1/2"-13 x 3 1/4" Bolts. Insert them into each Bracket/Bushing hole from the outside with the threads pointing to the center. Install a 1/2" Flat Washer and 1/2"-13 Nylok Nut on the threads of each bolt and tighten to 50 ftlbs.



23. **Image 23** illustrates a correctly installed upper wishbone.



Wishbone Axle Mount Installation



24. Remove the bolt that attaches the brake line junction block to the bracket. The junction block will be reattached later.

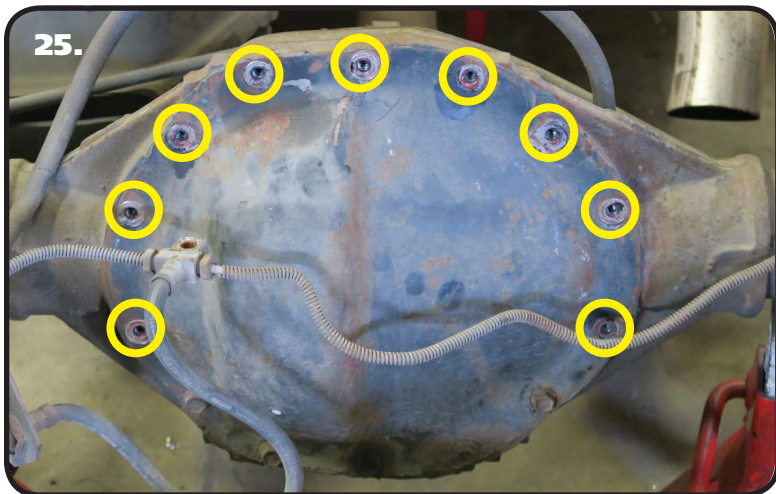

25. Remove the top (9) bolts of the differential cover leaving in the bottom (3). The emergency cable will NOT be reattached to the top bolt of the axle. It will get relocated later.

IF THE DIFFERENTIAL COVER HAS A GASKET BETWEEN IT AND THE HOUSING, IT WILL NEED TO BE REMOVED AND SEALED WITH RTV SEALANT. Be sure to refill the differential with the correct gear oil before driving.

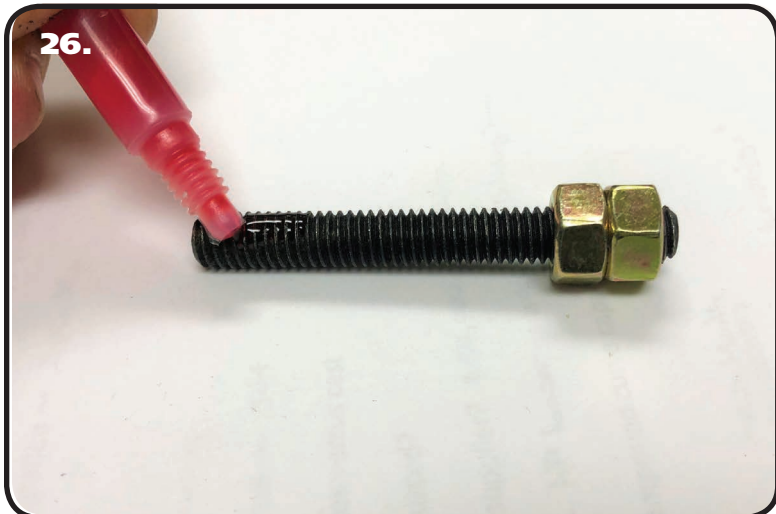

26. The 9 OEM bolts that were removed from the top of the differential cover will be replaced with M8-1.25 x 50mm Studs. These Studs and the nuts used to install them are supplied in the Hardware Bag labeled "Upper Wishbone Differential Mount". Thread the (2) M8-1.25 Hex Nuts on one of the studs. Using (2) wrenches, tighten the nuts against each other locking them together. Apply Red Loctite to the other end of the stud.



Wishbone Axle Mount Installation

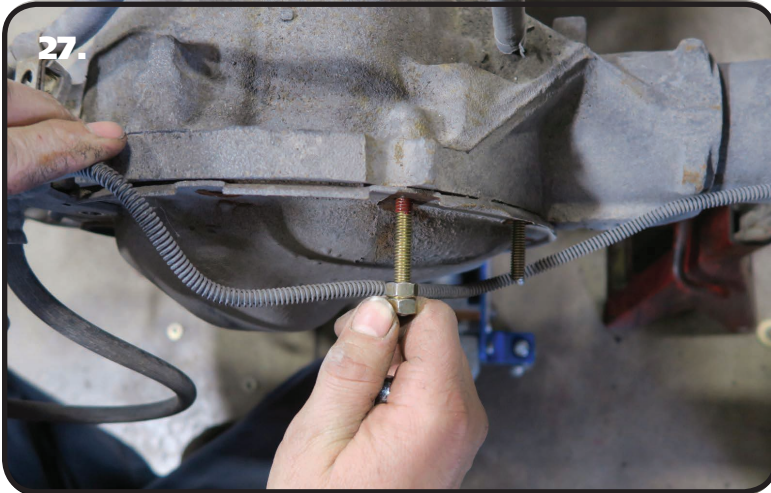

27. Thread the Stud into one of the 9 threaded holes in the axle housing. Torque the Stud to 169 inlbs. Use 2 wrenches to unlock the nuts from each other and remove them from the stud. Repeat the process on the remaining 8 studs.



28. Position the Axle Bracket/Wishbone in place with the wishbone to the front of the truck. Line up the (9) holes in the axle bracket with the (9) studs of the Differential.

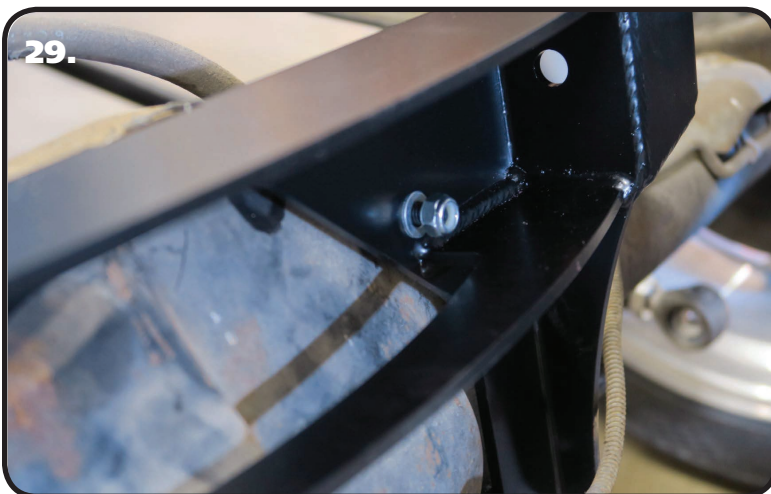

29. Using the Hardware Bag "Upper Wishbone Differential Mount", install a M8 Flat Washer & M8-1.25 Nylok Nut on each of (9) M8 Studs. Torque to 225 inlbs



Wishbone Installation

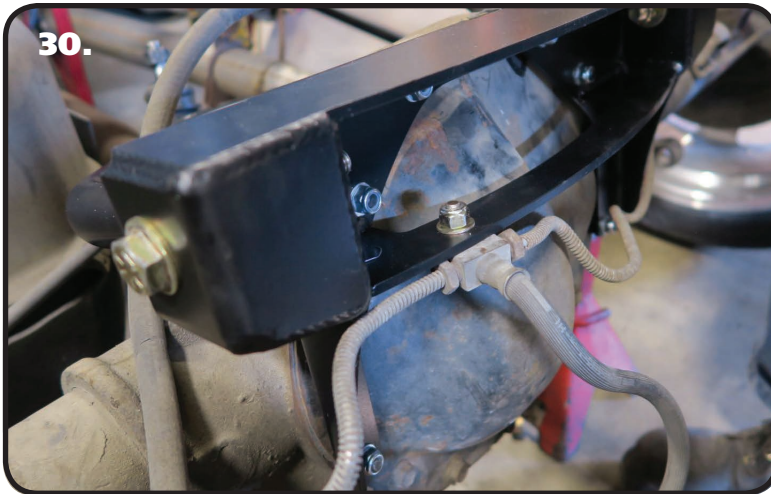

30. Using the Hardware Bag "Brake Line Junction Block", install a 5/16" Flat Washer on a 5/16"-18 x 1 1/2" Bolts. Insert the bolt/washer through the junction block and mounting hole in the differential bracket. Install a 5/16" Flat Washer & 5/16"-18 Nylok Nut on the threads of the bolt. The brake lines will need to be tweaked to get the distribution block in position. Torque the bolts to 25 ftlbs.



31. Insert the ball joint pin into the opening of the upper bridge. Push it up in the hole and install the castle nut supplied in the kit.



32. Torque the ball joint nut to 50 ftlbs. Verify if the hole in the ball joint pin aligns with any of the slots of the castle nut. Tighten the castle nut to align them. **DO NOT LOOSEN THE CASTLE NUT.** The thread the grease zerk into the ball joint and grease it.



Shockwave/Coilover Mounting



33. Insert the 1/2" ID Shock Bearing Spacer into each side of the ShockWave/CoilOver Bearing. Install a 1/2" Flat Washer on a 1/2"-13 x 2 3/4" Bolt. If installing ShockWaves, insert the top of the shock into the shock mount on the c-notch with the adjusting knob to the outside. If installing CoilOver, insert the bottom of the shock into the shock mount on the c-notch. Line up the holes and insert the bolt/washer. Install a 1/2" Flat Washer and 1/2"-13 Nylok Nut on the threads and tighten to 50 ftlbs.



34. The Shock Stud requires spacers that are .400" long (90002067). Install a 5/8" ID 90002067 spacer (**Small side towards shock body**) onto the lower Shock Stud. Slide the bottom of the Shock onto the Stud. Install a second 5/8" ID 90002067 Spacer onto the Stud (**small side towards shock**). You may need to jack the rearend up to Slide the Shock onto the Stud.

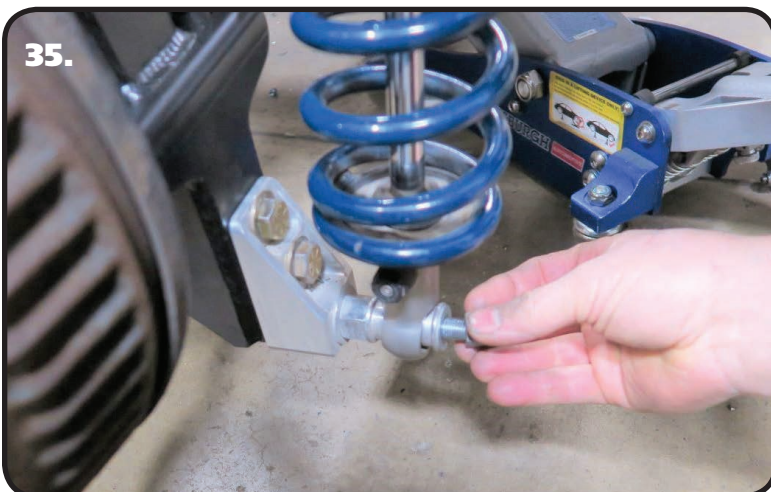

35. Install the 7/16" Flat washer and 7/16" Nylok nut. Tighten the upper and lower shock bolts. Torque the Upper Bolt to 50 ftlbs and the Lower Nut to 40 ftlbs. The designed ride height of the CoilOver/Shockwave is 14 1/2" center to center.



Carrier Bearing, Emergency Brake Cable Relocation

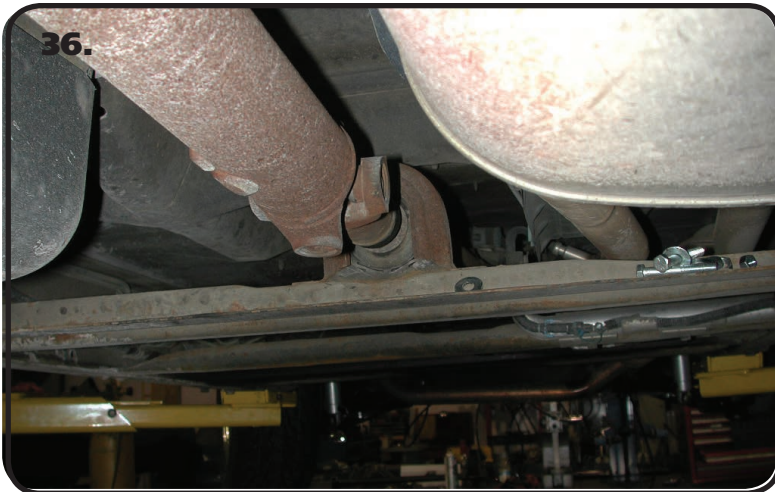

**TRUCKS WITH CARRIER BEARINGS ONLY!
IF YOUR TRUCK DOESN'T HAVE A CARRIER
BEARING, SKIP TO STEP 38**

36. The driveshaft carrier bearing will need to be relocated to optimize driveline angles at your new lower ride height. Unbolt the carrier bearing.

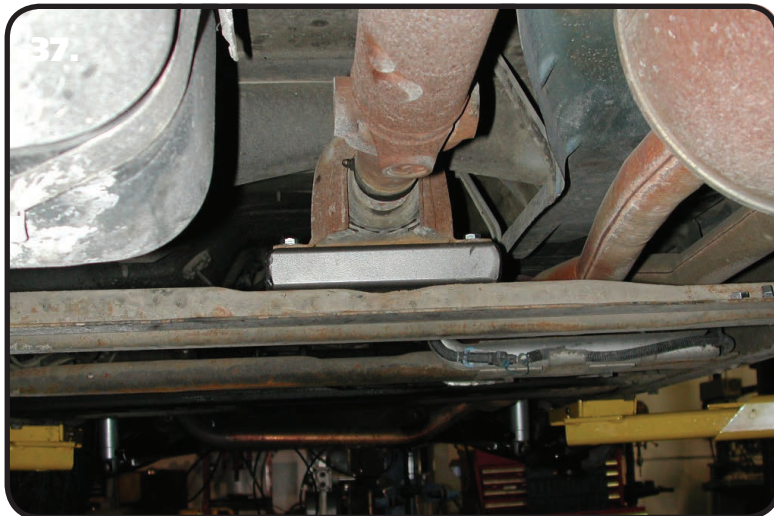

37. Install carrier bearing spacer between carrier bearing housing and cross member. Secure with 3/8" x 2 1/2" bolts, 3/8" flat washers, & 3/8" nylok nuts.



38. On some years, the emergency brake cable mounting will need to be modified for clearance. If your cable mount on the snout of the differential looks like **Image 38**, no changes will be needed. If it looks like **Image 39**, the mount will need to be flipped around.



Emergency Brake Cable Relocation, Bed Modification



39. If your emergency brake cable mount looks like **Image 39**, the mount will need to be flipped around. Start by removing the nut from the attaching bolt. Next, remove the bolt to detach the mount from the snout of the differential.



40. Use a flat bladed screwdriver to remove the mount from the emergency brake cable. Flip it around so that the bolt hole is to the rear of the truck. Use a pair of pliers to snap the mount back onto the cable.



41. Slip the mount back in position on the snout of the differential. Reattach it with the OEM hardware that was removed previously. Push the cable down as far as it will go before tightening the hardware. With it in position, tighten the hardware.



Bed Modification



42. Trimming of the bed brace that is in between the wheel wells is necessary to clear the c-notches and wishbone. We cut ours with a diegrinder and cut off wheel. **Image 42** illustrates the bed brace cut out. The cut starts 4" from the end of the brace and runs all the way across leaving 4" on the other end. It needs to be cut even with the flange that attaches the brace to the bed floor.



43. Your bed brace should look like **Image 43** after cutting.

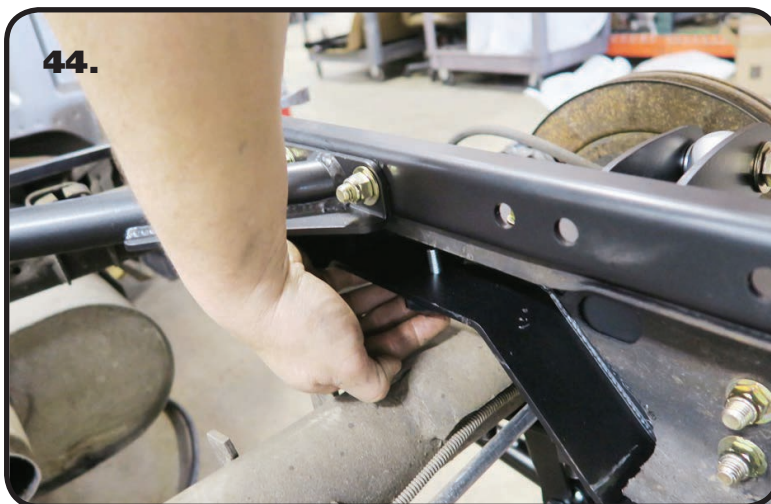

44. If you haven't already, install the bump stops into the c-notch above the axle using the 3/8" flat washer and 3/8"-16 nylok nut supplied. A bumpstop will need to be installed in each c-notch.

45. Reinstall the bed.

46. Set ride height on the truck. The ride height of the Shockwave/CoilOver is approximately 14 1/2". If you are using ShockWaves, this is done by changing the air pressure in the ShockWaves. If you are using CoilOvers, the ride height is done by using the adjuster nut for the coil spring. The coil spring on the CoilOver will have some preload in the spring to get ride height, this is normal.