

Installation Guide & Operation Manual

RidePRO



Thank you for choosing a RideTech air suspension control system. We are committed to providing the best experience possible throughout the process of getting your car on air.

Our commitment doesn't end with your purchase, in fact, it has only begun. This guide should provide you with the information you need to properly install and set-up your suspension control system.

However, if you find yourself having difficulty or if you have a question that isn't covered in this book, please call our tech department.

Tech Line: 812-481-4969

In addition to phone support, our web site also provides a wealth of helpful product / install / set-up information.

Contents

Component Installation

Mounting compressor	2
Mounting tank	2
Mounting air valves	2
Routing air lines & fittings	3
Mounting pressure sensors.....	3
Mounting the controls & ECU.....	3
Wiring.....	3

LevelPRO Installation

Installing external ride height sensors.....	4
Installing internal ride height sensors.....	4
Sensor Rod Assembly.....	5
Example installations	5

AirPod™ Installation

Mounting the unit	6
Wiring.....	6

Quick Start	7
-------------------	---

Operation & Controls

Button description	8
Setting presets.....	8
Selecting presets.....	8
Tank button.....	8

Menu

Activating / navigating menu	9
Menu structure.....	9-10
Menu functions	11-12
Remote control.....	12

Troubleshooting guide	13-14
------------------------------------	--------------

Plumbing Diagrams.....	15
-------------------------------	-----------

Wiring Diagrams.....	back cover
-----------------------------	-------------------

Installing a RidePRO System

RidePRO digital Part #: ARC4000digital • ARC4100digital • ARC4700digital • ARC4800digital LevelPRO Part #: ARC4000L • ARC4100L • ARC4700L • ARC4800L

STOP Remove the negative battery cable before beginning



Mounting the Compressor

- All of our compressors are sealed for moisture and dust resistance so they can be mounted anywhere on the vehicle. Although it is best to mount it in a place out of direct contact with rain and snow. It is OK to mount it underneath the vehicle but keep it inside the frame rails away from water and debris thrown off the tire.
- This is a dry compressor; therefore it is maintenance free and can be mounted in any position.
- It is best if mounted to something solid to reduce vibration and noise. If mounting it to sheet metal or the bed of a truck use sound deadening material between the compressor and the mounting surface.
- Use the rubber grommets supplied on the feet of the compressor to reduce vibration.
- Attach the grey wire from the main power harness to the black wire on the primary compressor. The red wire connects to +12V
- Thomas Compressors (black) will require a 20 amp fuse (each).
- Viair Compressor (silver) will require a 30 amp fuse (each).

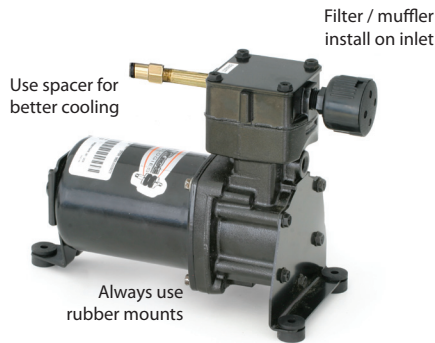

Mounting the Air Tank

- The air tank can be mounted anywhere on the vehicle in any position, So long as the sensor is not pointed down.
- There is an 1/8" port in the tank that will accept the tank pressure sensor.

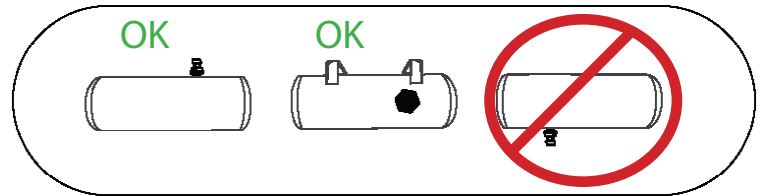

Mounting the RidePro Air Valves

- The valves, like the compressor, are sealed and can be mounted in the same locations. Although if the vehicle will be exposed to freezing temperatures it is a good idea to mount them in the engine bay if possible to reduce the possibility of freezing.
- They can be mounted in any position.
- Attach the ground strap to a good, clean ground (preferably the frame).
- The exhaust port will be left open.
- The valve is held closed with the pressure in the tank. If tank pressure drops below air spring pressure they will equalize, deflating all 4 air springs.

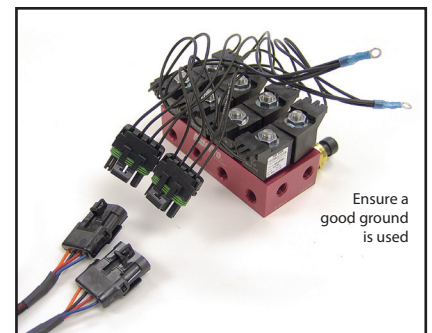

NOTE:

The digital system switches ground on the compressors, the compressors are provided power at all times.

(DO NOT INSTALL ADDITIONAL RELAY)

The digital system monitors voltage and use of additional relay will cause error codes.

Routing the Airline and Fittings

- Make all airline cuts with a razor or tubing cutter (part # - 90001081). It must be clean and straight or it will not seal.
- All fittings are DOT approved push-to-connect style. They are very simple to use and are reusable. Firmly push the airline into the fitting to attach. To release the airline push the collar on the fitting back towards the fitting and pull the airline out.



- **Use thread sealant on all fittings.**
- Do not over tighten the fittings. This could result in breaking the fitting or damaging the air spring.
- All of our airlines are DOT approved so they are very strong. But keep them away from any sharp edges. Also when passing through a hole in the frame use a grommet.
- Keep away from intense heat including mufflers and exhaust manifolds.
- Use zip ties or other fasteners to secure the airline.

Mounting the ECU (Electronic Control Unit) & Control Panel

- The ECU is water proof and may be mounted in the engine bay or under the vehicle.
- The control panel should be accessible from the drivers seat and may be mounted or left unmounted.
- The control panel cable uses mini USB connectors. Extensions can usually be found locally or purchased from RideTech.

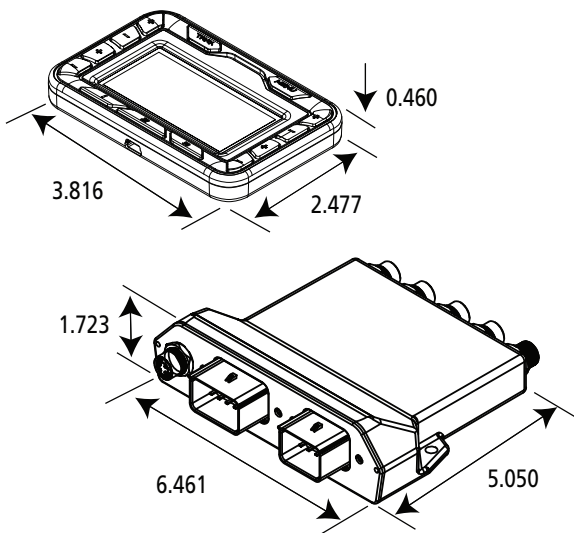

Main Power Harness

- Black wire**
A clean chassis ground
- Yellow wire**
Ignition
(12 volts only when the key is on)
- Red wire**
Constant 12 volt
- Grey Wire**
Primary Compressor Ground
- Blue Wire**
Secondary Compressor Ground (OPTIONAL)

Mounting the Air Pressure Sensors

- These sensors are voltage based and do not need to be grounded.
- Use thread sealant when installing pressure sensors in valve block.
- Sensors can not be pointed down (debris can collect and cause false readings)

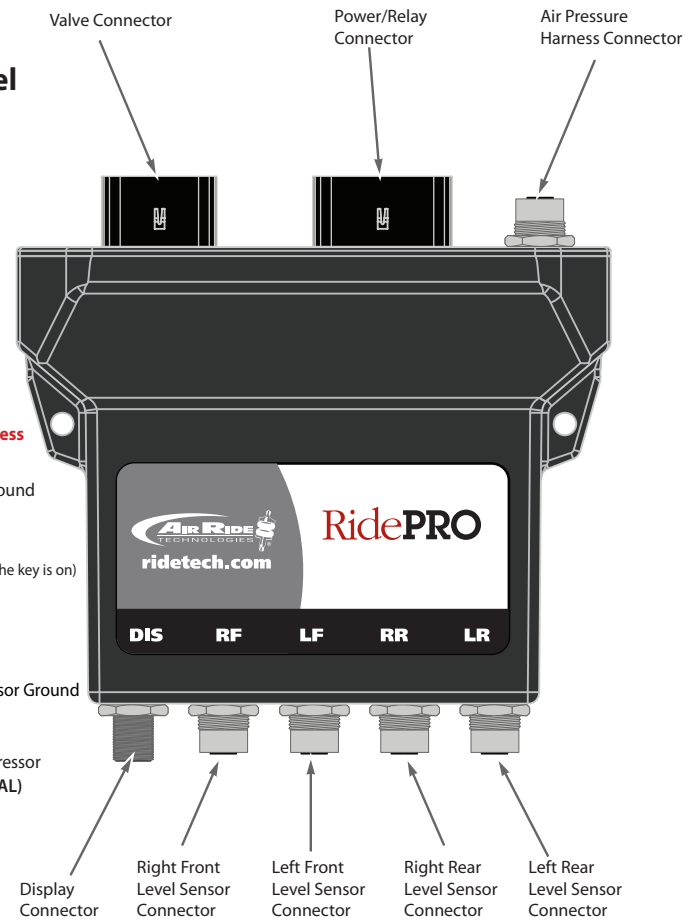
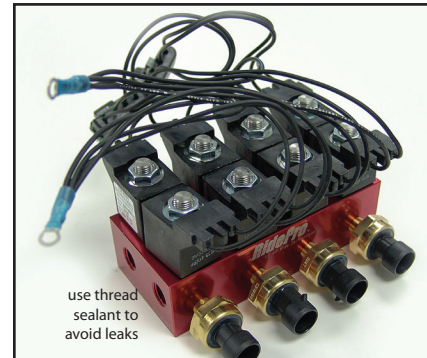

Height Sensor Harnesses



Pressure Harness



Display / Controller Harness



Valve Block Harness



Main Power



LevelPRO[®] Ride Height Sensors

External LevelPRO Sensor Installation

- The LevelPro system uses 4 height sensors (one at each wheel). They are weather proof and may be mounted in any position as well as “clocked” in any position. (There is not a difference between the left and right sensors.) These sensors are typically mounted to the chassis / frame rail.
- A linkage with rubber ends connects the sensor arm and a suspension component. On most front suspensions the linkage will attach to the upper or lower control arm. On most rear suspensions it will attach to the axle or control arm.
- **The main goal when mounting the sensor is to achieve as much sensor rotation as possible without exceeding the sensors limits.**
- Although the sensor arm will rotate 180 degrees, it must remain in the middle 90 degrees throughout suspension travel. See diagram below for sensor travel limits.
- It may be necessary to shorten the sensor arm and drill a new hole to ensure the arm is rotating enough during suspension travel to accurately determine vehicle height.
- The sensor arm can also be removed from the sensor and clocked in four different positions. It may also be necessary to bend the sensor arm and/or linkage to achieve proper clearance and alignment.
- The sensor will be mounted to the frame using ¼” self tapping screws or bolts. A special shouldered bolt is supplied to attach the rubber rod ends to the suspension and the sensor arm, this will avoid over tightening.
- Make sure the sensor has adequate clearance from all suspension components throughout suspension travel. Check tire clearance, lock to lock and throughout suspension travel.

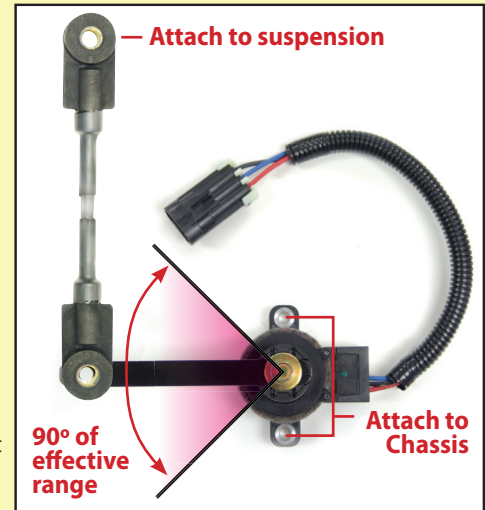

Travel Limits

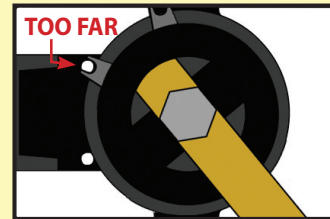
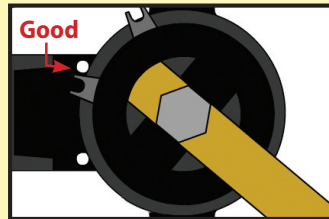
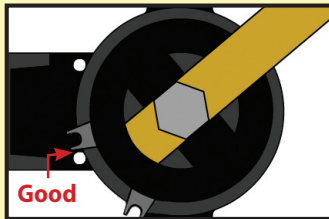

- ⚠ If the electrical range of travel is exceeded the system may function erratically or not at all.
- ⚠ Also note that if the sensor has very little travel the LevelPro system may not perform to its potential.
- ⚠ It may be necessary to shorten the sensor arm to increase travel.

Assembly of the LevelPRO Sensor Link Rods



1- Once the linkage rod has been cut to the proper length assemble the linkage rod with heat shrink tubing and the rubber end.

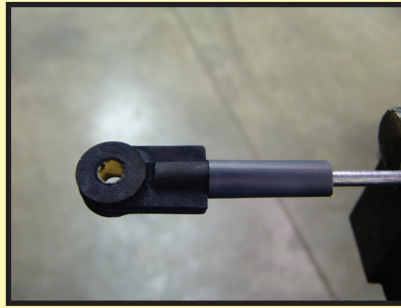

2- Slide the heat shrink tubing over the rubber end as far as it will go.

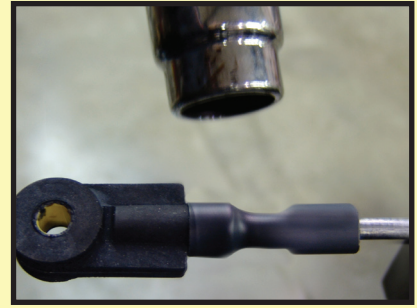

3- Heat the shrink tubing with a heat gun (hair dryer or small torch will work). **Begin by heating the rubber end first.** The heat shrink is lined with adhesive and will stick to the rubber when heat is applied.



4- Continue shrinking the tube to the rod until secured. Be sure not to overheat the tubing causing it to pull from the rubber end.

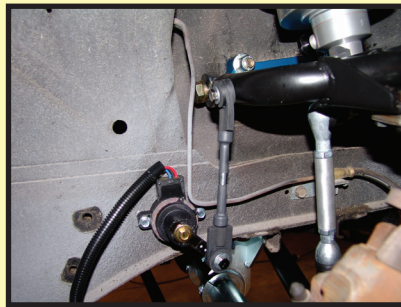

5- Once both sides of the linkage have been finished secure the linkage to the sensor and suspension.

Sensor Mounting Examples



69 Camaro Front



Rear Trailing Arm



58-64 Impala Front

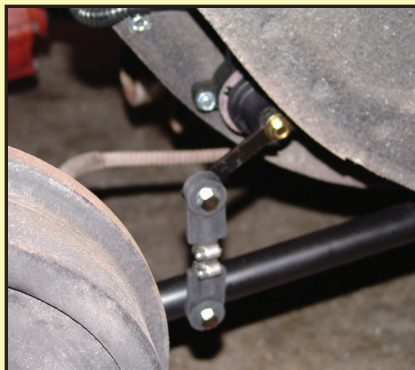

65-70 Mustang Rear



Triangulated 4-Link Rear

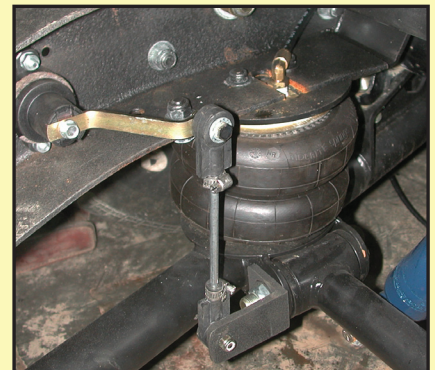

C-10 Truck Rear

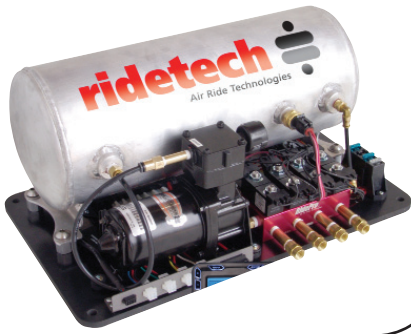

Installing an AirPod

AirPod Part #: APOD4000L APOD4000digital APOD4100L APOD4100digital

STOP Remove the negative battery cable before beginning installation.

MOUNT THE MAIN UNIT:

- 1- Mount the base flat to the vehicle surface (do not bend the base)
- 2- Secure the base with self tapping screws or bolts.
- 3 - If Optional cover is used, Secure the cover to the airpod base using the supplied screws.

CONNECT AIR LINES:

- 1 - Airline cuts must be straight and clean - use a razor blade or tubing cutter. (part # - 90001081)
- 2 - All fittings are DOT approved, reusable, push-to-connect style. Firmly push the airline into the fitting to attach. To release the airline push the collar on the fitting back towards the fitting and pull the airline out.
- 3 - All of our airlines are DOT approved so they are very strong. Secure the airline with zip ties, keep them away from any sharp edges and when passing through a hole in the frame use a grommet.

CONNECT POWER HARNESS:

- 1 - Connect the red power wire directly to the battery. Use included fuse within 18" of battery.
- 2 - Connect the yellow ignition wire to switched 12v. **(Fuse Panel is the best location)**
- 3 - Connect the black wire to chassis ground.



Be sure to use included fuse holder in the battery feed wire as close to the battery as possible.

CAUTION: Use 8 gauge wire or larger to extend red power feed if needed

CONNECT LEVELPRO SENSORS (if equipped):

See LevelPRO section for more information on installing and calibrating height sensors.

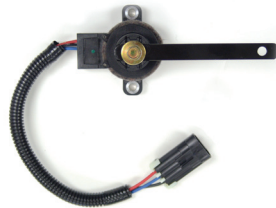

CONNECT DISPLAY / CONTROLS:

See control programming and additional features section for more information on using the control panel.

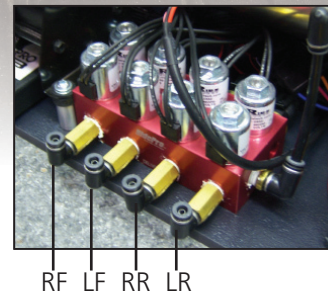

Calibration

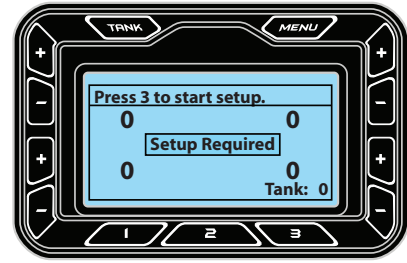
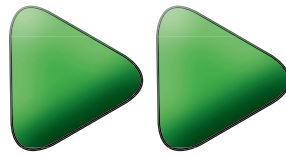

Calibration:

During the Calibration sequence the digital records information specific to the vehicle in which it is installed (inflate and deflate speed, if level sensors are present, how long the compressors take to fill the storage tank, etc.) The digital then uses this information to attain the proper preset heights in the fewest possible steps, using the most intelligent method. For example, after calibration the digital knows that the front of the vehicle is heavier and therefore slower than the rear, so it will inflate the front first then allow the rear to catch up just as the vehicle is achieving ride height.

NOTE: The RidePRO digital system is a very intelligent system. Attempting to calibrate this system on a non running vehicle will cause errors. Trying to hook the system up for a "TEST RUN"? When the system is powered up it will work manually using the inflate and deflate buttons only. The preset buttons will not work until calibration is complete. **Calibration should not be run until vehicle is running and driving.**

RidePRO SYSTEMS (No Level Sensors)

Calibration Steps: (items in red require user interface, other steps are automatically completed)

These steps will require the car to be running to ensure full battery voltage!

1. Start the vehicle
2. Allow the compressor/compressors to fill the tank (They will shut off @ 150psi)
3. Press preset # 3 to start calibration.
4. Release all air - this provides a solid starting point for the Calibration sequence
5. Locating tank pressure sensor - locates and checks the tank sensor
6. Locating air spring pressure sensors - locates and checks the air spring pressure sensors
7. User must set Preset #2 - allows the user to set the Ride Height (This can be changed later)
8. Check vehicle speed to and from Preset #2 - the digital will utilize this information to achieve Ride Height in the fewest possible steps using the most intelligent method.
9. Determines vehicle speed from lowered height to Preset #2 - the digital will utilize this information to achieve Ride Height in the fewest possible steps using the most intelligent method
10. Deflates down to Preset #1 - tests the system for deflating to Preset #1
11. Uses Calibration data to travel to Preset #2 - tests the system for inflating to Preset #2

LevelPRO SYSTEMS (with Level Sensors)

Calibration Steps: (items in red require user interface, other steps are automatically completed)

These steps will require the car to be running to ensure full battery voltage!

1. Start the vehicle
2. Allow the compressor/compressors to fill the tank (They will shut off @ 150psi)
3. Press preset # 3 to start calibration.
4. Releasing all air - this provides a solid starting point for the Calibration sequence
5. Locating tank pressure sensor - locates and checks the tank sensor
6. Locating air spring pressure sensors - locates and checks the air spring pressure sensors
7. User must raise to Max, then press and hold Preset #3 - sets the upper limit of suspension travel
8. Locates level sensors - level sensors will be automatically displayed
9. Determines suspension type - different suspension types will utilize different software to achieve preset heights
10. User must set Preset #2 - allows the user to set the Ride Height
11. Check vehicle speed to and from Preset #2 - the digital will utilize this information to achieve Ride Height in the fewest possible steps using the most intelligent method
12. Determines how much air pressure is required to slightly lift the vehicle - this information allows the digital to more efficiently manage air usage
13. Determines vehicle speed from lowered height to Preset #2 - the digital will utilize this information to achieve Ride Height in the fewest possible steps using the most intelligent method
14. Deflates down to Preset #1 - tests the system for deflating to Preset #1
15. Uses Calibration data to travel to Preset #2 - tests the system for inflating to Preset #2
16. Calibration complete

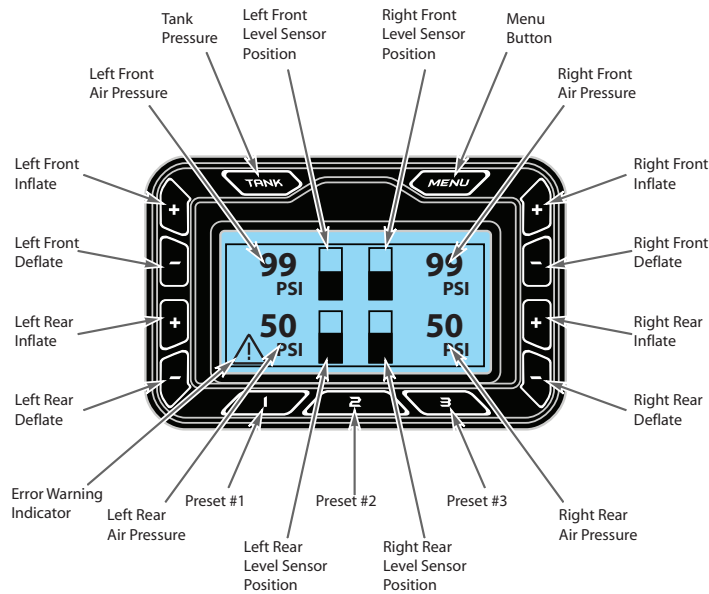

INFLATE & DEFLATE BUTTONS

You have full manual control at any time. To inflate an air spring simply press and hold the corresponding "+" button. To deflate an air spring simply press and hold the corresponding "-" button. The corresponding air spring will be inflated OR deflated until the button is released.

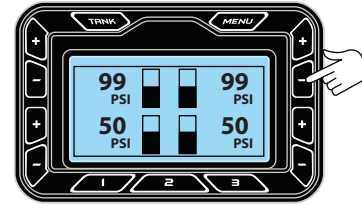

PRESET BUTTONS

There are three preset buttons located on the lower portion of the display. These can be learned to any height, but normally they are set as:



= Deflated Setting



= Ride Height



= Inflated Setting

SETTING PRESETS

Use inflate and deflate buttons to obtain desired vehicle height. To store the height as a preset **press and hold the preset button for 5 seconds** or more. The screen will display "Preset is saved" when completed

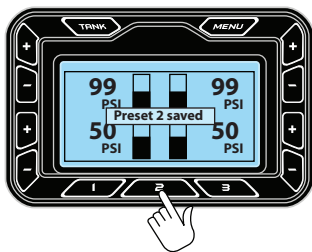

Press and hold for over 4.5 seconds to store current ride height as a preset

SELECTING PRESETS

To select a preset **press and hold the preset button for a half-second** and no longer than 5 seconds. (The delay is required to minimize accidental activation of presets.) The screen will display "Preset selected" when activated.

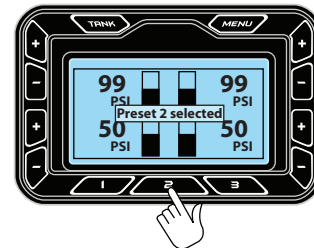

Press preset for 0.5 second to activate preset

TANK BUTTON

Tank pressure can be viewed at any time by pressing the TANK button.

The tank pressure will be displayed until the button is pressed again.



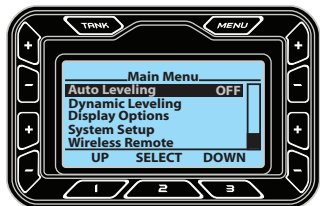

The main menu is used to change system parameters, such as increasing the brightness of the screen, or the menu is used to access system information, such as viewing your preset pressures and level sensor settings.

To enter the Main Menu simply press the **MENU** button.

Once in the menu you can scroll up using the **1** button, scroll down using **3** the button, or select a menu item by pressing the **2** button.

You may go back a screen by scrolling to the bottom of each page and selecting the "BACK" button, or by pressing the **MENU** button.

MENU STRUCTURE

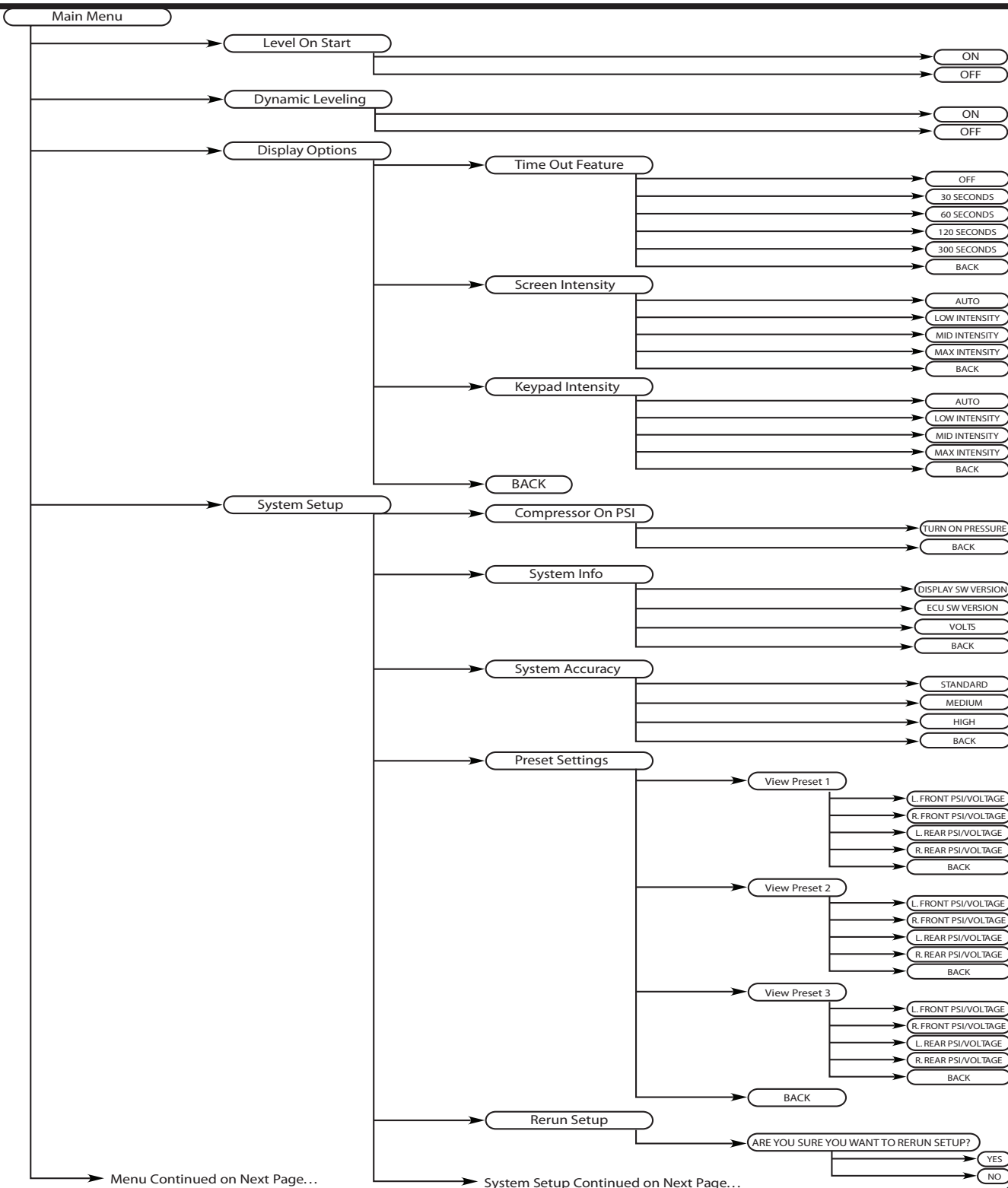

MENU STRUCTURE (continued)

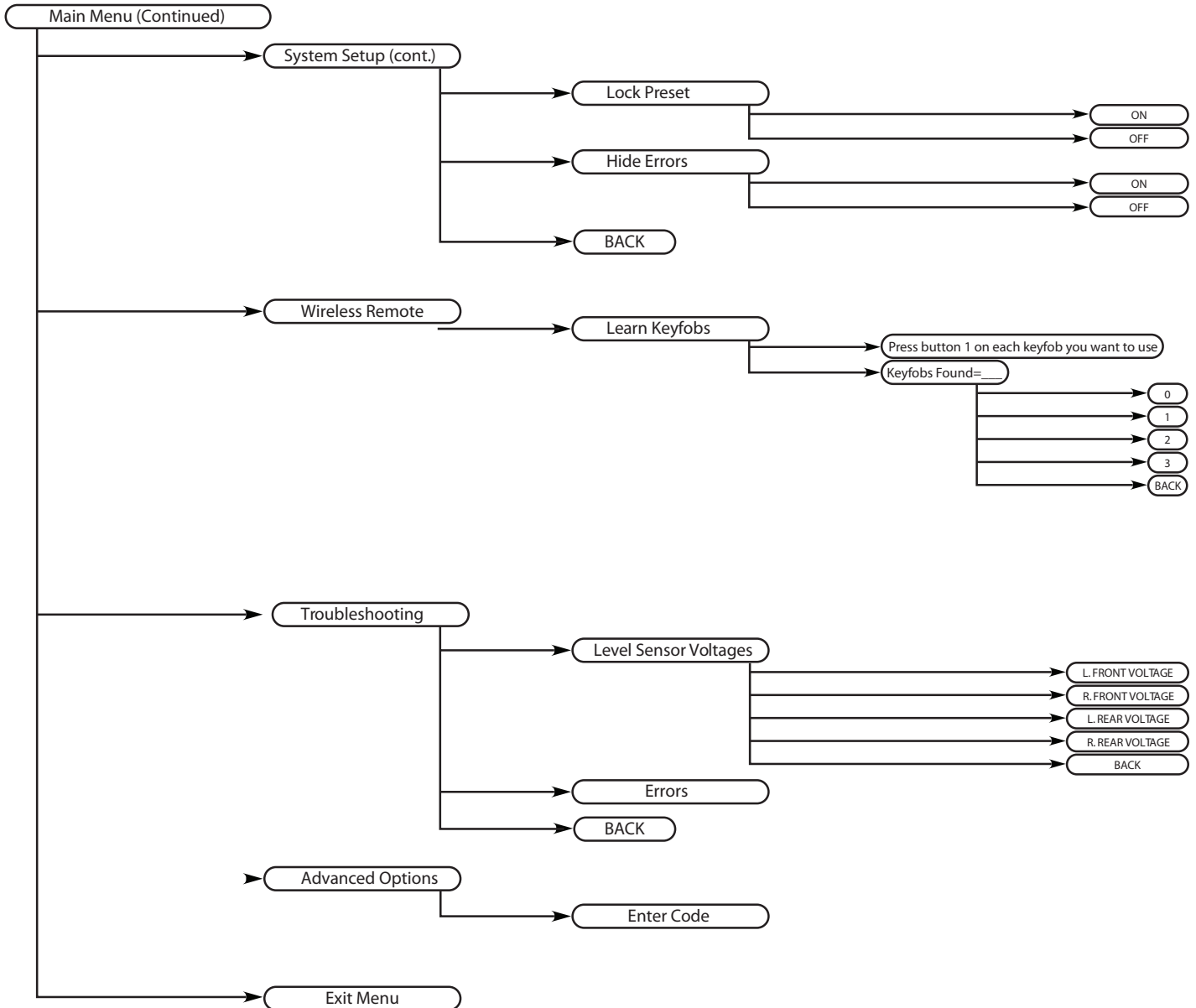

RidePRO

Menu Options - Details

AUTO LEVEL

The Auto Level on Start feature is used to raise the vehicle to the #2 Preset each time the ignition is turned on.

ON:

When vehicle is started it will return to the #2 Preset.

OFF:

When vehicle is started it will not automatically adjust to any setting

DYNAMIC LEVELING:

Dynamic Leveling will automatically raise or lower the vehicle back to the #2 Preset if the load changes while the vehicle is parked. As soon as the vehicle is in motion the system stops adjusting as it's unsafe to alter air spring pressure while driving.

ON:

The vehicle will return to the #2 Preset if the load changes.

OFF:

The vehicle will not adjust if the load changes.

DISPLAY OPTIONS

Display Options allows you to change items such as the brightness of the screen or buttons as well as how long the screen will remain illuminated.

TIME OUT FEATURE:

The display screen and button backlights can remain illuminated at all times, or if you wish they can turn off after some time.

OFF: The display will remain on as long as the ignition is on.

30 SECONDS: The display will remain illuminated for 30 seconds.

60 SECONDS: The display will remain illuminated for 1 minute.

120 SECONDS: The display will remain illuminated for 2 minutes.

300 SECONDS: The display will remain illuminated for 5 minutes.

SCREEN INTENSITY:

The intensity of the display screen backlighting can be automatically adjusted depending on ambient light conditions, or it can be changed to 3 intensity levels.

AUTO: The backlight intensity will change with ambient light conditions.

LOW INTENSITY: The backlighting will remain at the lowest intensity.

MID INTENSITY: The backlighting will remain at a medium intensity.

MAX INTENSITY: The backlighting will remain at the brightest setting.

KEYPAD INTENSITY:

The intensity of the button backlighting can be automatically adjusted depending on ambient light conditions, or it can be changed to 3 intensity levels.

SYSTEM SETUP

System Setup allows you to change items such as system accuracy and compressor turn on pressure. You can also view system information such as preset settings and software revision.

COMPRESSOR ON PSI:

The compressors can be configured to turn on anytime the pressure drops below 125 to 140psi. Setting the turn on pressure higher will make the compressors run more often, but for a shorter length of time. Setting the turn on pressure lower will make the compressors run less often, but they will run for a longer amount of time.

SYSTEM ACCURACY:

The System Accuracy feature allows the user to choose how precise the system is when attempting to reach a preset destination. This feature satisfies all drivers (some like to wait for the system to reach preset before driving away while others want to start the car, throw it in drive and take off)

STANDARD: The vehicle will reach the preset destination in as few operations as possible. This is acceptable for most applications.

MEDIUM: The system will be slightly more precise than the Standard setting which means it will take a few more steps to reach a more precise target.

HIGH: This is the most accurate the system can be. It will take longer to reach the preset destination, but you can be assured that the vehicle is at the exact preset height.

PRESET SETTINGS:

Should you ever need to know the values that are saved for the three preset settings they can be accessed here.

If you are using an air only system you will only see pressure readings for each air spring.

If you are using an air and level sensor system you will see both air pressure readings as well as level sensor voltage readings.

RERUN SETUP:

Should you ever need to recalibrate the system you may do so by rerunning the setup procedure.

When you choose to rerun the setup you will be asked:

"ARE YOU SURE YOU WANT TO RERUN SETUP?"

You may select YES by pressing the "1" button, or select NO by pressing the "3" button.

SYSTEM INFO:

This is where you find the software revision of both the display and ECU as well as a volt meter to aid in troubleshooting.

DISPLAY SW VER: This is the software version that is loaded into the display.

ECU SW VER: This is the software version that is loaded into the ECU.

VOLTS: This is a digital voltmeter that will show you the voltage of the vehicle.

Lock Presets:

Lock presets gives the user the option to lock presets so they can not be changed.

Hide Errors:

Gives you the option to keep all error codes from displaying on the screen.

WIRELESS REMOTE LEARN KEYFOBS

The Digital system has the capability of learning up to 4 remote keyfobs.

Learning new keyfobs is as simple as entering the menu selecting remote function, and pressing the #1 button on each keyfob, one at a time, until all keyfobs are learned into the system. Each new keyfob will be recognized by the Digital system and the corresponding number will be displayed on the screen.

REMOTE CONTROL INSTRUCTIONS

1. Unplug the digital Display
2. Plug the cable from the ECU into the smaller USB port of the Remote Module (USB Port; from ECU)
3. Plug the supplied USB cable into the larger USB port of the Remote Module (USB Port; to Display)
4. Plug the smaller end of the supplied USB cable into the digital Display
5. Plug the antenna into the Remote Module (Antenna Port)
6. Plug in the Ground Input harness if you are using custom switches (if you are not using custom switches you do not need to use the Ground Input harness.)
7. Learn the keyfobs into the digital system by following the steps below.



Programming Keyfobs:

- 1- Once the Remote Module is installed you may learn the keyfobs into the digital system.
- 2- Enter the Menu via the digital Display
- 3- Enter the "Wireless Remote" Menu
- 4- Highlight the "Learn Keyfobs" Menu and Press # 2 (Select)
- 5- Press the #1 preset button the first keyfob
- 6- Press the #1 preset button on the second keyfob

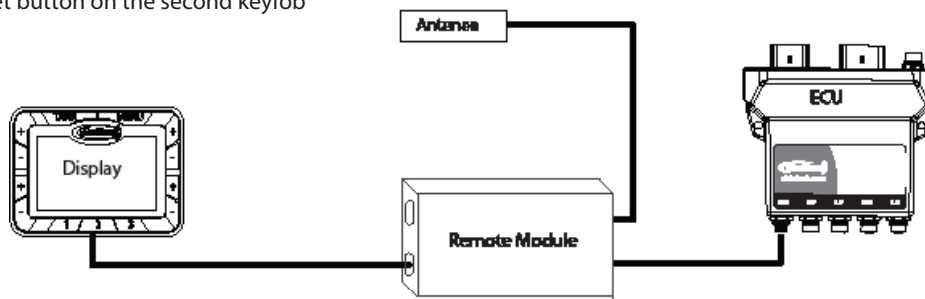
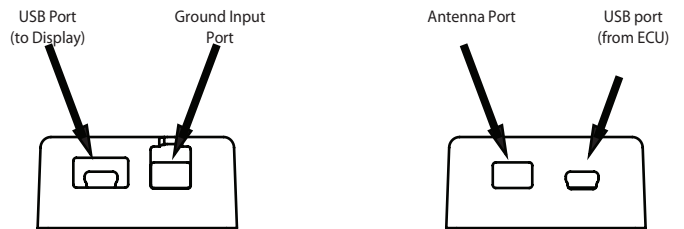

OPTIONAL

Ground Input Harness:

The digital Remote Module allows you to trigger the three presets with custom switches or any auxiliary device that supplies a ground output (car alarms, remote shaved door kits, etc.)

If you are using custom switches:

- 1- You will need to source momentary contact switches. Connect one side of each switch to ground. (A black ground wire is supplied in the 4 pin connector)
- 2- Connect the other side of the switch to the corresponding colored wire of the Remote Module:
Blue – Preset 1 Yellow – Preset 2 Grey – Preset 3 Black – Ground
- 3- Once the digital system goes through Calibration the Display can be removed. The 3 ground inputs can be used at any time.

TROUBLE SHOOTING

The Digital system keeps a log of each error message that has been triggered. You may enter the Troubleshooting area of the menu for assistance in resolving any error. (errors are indicated by a ∇ on the main screen) Simply select the error you wish to resolve and the Digital system will walk you through the same steps our tech support staff uses to help you resolve the issue.

LEVEL SENSOR VOLTAGE

The level sensor voltage allows you to check the voltage at the level sensor at certain heights. If the level sensor is out of range it can be checked here.

ADVANCED OPTIONS

The Advanced Options menu is a place where we keep tools and utilities to assist our staff in setting up or troubleshooting any area of the Digital. The Advanced Options menu is accessible only with a pass code.

<p><u>Compressor will not turn on.</u></p> <p><u>Diagnosis A:</u> 12 volts not present at Red wire on compressor.</p> <p><u>Solution A:</u> Check fuse and connections. (20 amp fuse on Thomas compressor) (30 amp fuse on Viair compressor)</p> <p><u>Diagnosis B:</u> 12 volts present at red wire on compressor but still doesn't run.</p> <p><u>Solution B:</u> 1. Check connections between Black wire on compressor and Blue/ Gray wire on ECU. Also check Black wire from ECU to Ground.</p>	<p><u>Compressor will not turn off.</u></p> <p><u>Diagnosis A:</u> Tank pressure reads 0 psi all the time or stays at the same pressure regardless of actual tank pressure.</p> <p><u>Solution A:</u> 1. Check harness and plugs. 2. Replace pressure sensor.</p> <p><u>Diagnosis B:</u> Tank pressure builds normally but will not reach 150psi.</p> <p><u>Solution B:</u> Replace compressor.</p>	<p><u>One air spring leaks down over a period of time.</u></p> <p><u>Diagnosis A:</u> Leak between delivery port on valve block and air spring.</p> <p><u>Solution A:</u> Air springs almost never leak. Spray all fittings with soapy water. Tighten fitting and/or remove and replace thread sealant. Cut 1" off of end of airline and reinsert.</p> <p><u>Diagnosis B:</u> Exhaust valves leaking. Air seeps past exhaust valve and out exhaust port.</p> <p><u>Solution B:</u> Usually caused by debris stuck on valve seat. Inflate and deflate several times or disassemble valve.</p>
<p><u>All 4 air springs leak down over a period of time.</u></p> <p><u>Diagnosis A:</u> Check tank pressure. There is a leak in the supply side of the system. This could be at the comp. , tank, or supply ports on the valve.</p> <p><u>Solution A:</u> Spray all fittings with soapy water. Tighten fitting and/or remove and replace thread sealant. Cut 1" off of end of airline and reinsert.</p>	<p><u>Presets work, but does not achieve target.</u></p> <p><u>Diagnosis A:</u> Air tank is too small. Air spring pressure equalizes with tank pressure before achieving preset pressure/height.</p> <p><u>Solution A:</u> Reprogram #1 preset for the highest psi that allows the suspension to bottom out. Will give it a "head start".</p> <p><u>Diagnosis B:</u> Tank pressure leaks down.</p> <p><u>Solution B:</u> Fix leak on supply side of system.</p>	<p><u>Presets work, but does not achieve target.</u></p> <p><u>Diagnosis C:</u> Pressure sensors and/or airline are not attached to corresponding air spring. (Ex: RF button must activate RF air spring and top right number on display.)</p> <p><u>Solution C:</u> Swap airline at delivery port on valve and/or air pressure sensor harness's.</p> <p><u>Diagnosis D:</u> Mechanical height sensors are out of range. Under "System Setup" check the presets voltages. If one or more are at 4.5v or .5v then the sensor is traveling beyond it's range of travel.</p> <p><u>Solution D:</u> Reduce or change travel of sensor by either changing linkage length, changing sensor arm length or by rotating sensor.</p>

NOTE:

Target on pressure based systems is + or - 7 PSI
Target on height based systems is + or - 1/4"

<p><u>Pressure reading are not moving, always reads 168 psi or 0 psi.</u></p> <p><u>Diagnosis:</u> ECU is not receiving a proper signal from the sensor.</p> <p><u>Solution:</u></p> <ol style="list-style-type: none"> 1. Check pressure sensor harness connections. 2. Replace sensor. 	<p><u>Height sensor bars read the incorrect corner.</u></p> <p><u>Diagnosis:</u> Ex: When inflating RF air spring LF bar increases</p> <p><u>Solution:</u> Swap height sensor harnesses at ECU.</p>	<p><u>Control panel switches do not activate the correct air spring.</u></p> <p><u>Diagnosis:</u> Ex: LF switch actuates the RF air spring.</p> <p><u>Solution:</u> Swap airline at the valve block.</p>
<p><u>Control panel switches activate the correct air spring, but the air pressures read the wrong air spring.</u></p> <p><u>Diagnosis:</u> Ex: Inflating the RF air spring changes the top left psi readout on the panel</p> <p><u>Solution:</u> Swap pressure sensor harnesses at the sensors.</p>	<p><u>Wireless remote control does not function.</u></p> <p><u>Diagnosis:</u> After programming remotes to ECU they still do not function.</p> <p><u>Solution:</u></p> <ol style="list-style-type: none"> 1. Check antenna connections. 2. Extension harness must be installed between remote box and control panel. 3. Red wire must be connected to a constant 12v, Yellow to switched 12v. 	<p><u>Display does not power up.</u></p> <p><u>Diagnosis:</u> With 12 volts present at the Red and Yellow wires on the ECU, the display does not power up.</p> <p><u>Solution:</u> Reset ECU. With key ON, pull fuse from Red wire on ECU. Replace fuse.</p> <p>Plug usb connector into other usb port on control panel</p>



TECH TIP

SUSPENSION BIND

Ever noticed that when you lower any vehicle off of a lift or jack stands that it is sitting several inches higher than normal? This condition is due to Suspension Bind, and all vehicles have it. Three dynamics lead to suspension bind:

1. Tire Scrub - The arc created by the control arm swing will try to push your tires apart or pull them together, (basically changing the track width). However, friction between the tire and ground does not allow the tires to slide, reducing vehicle movement. This can be especially dramatic with sticky tires and concrete.
2. Control Arm Bushing – Friction between the bushing and the frame brackets will also reduce vehicle movement. This is why control arm bolts must be tightened at ride height. Over tightening the bolts can lead to very excessive suspension bind.
3. Shock Absorbers – The shock absorbers job is to reduce suspension movement. The stiffer the shock absorber, the more suspension bind.

With an air suspension vehicle it is always best to over inflate the air spring and then deflate back down to the target pressure to alleviate some suspension bind.

Single Compressor Systems

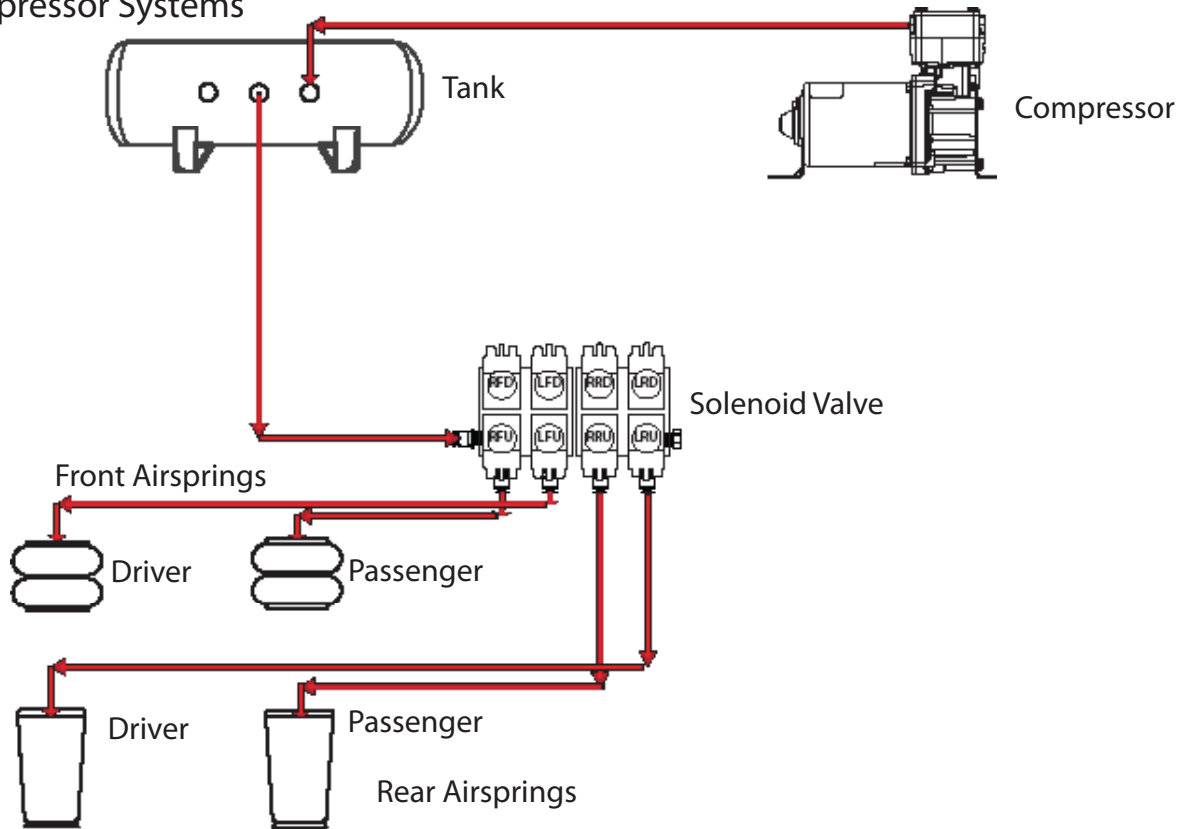

Dual Compressor Systems

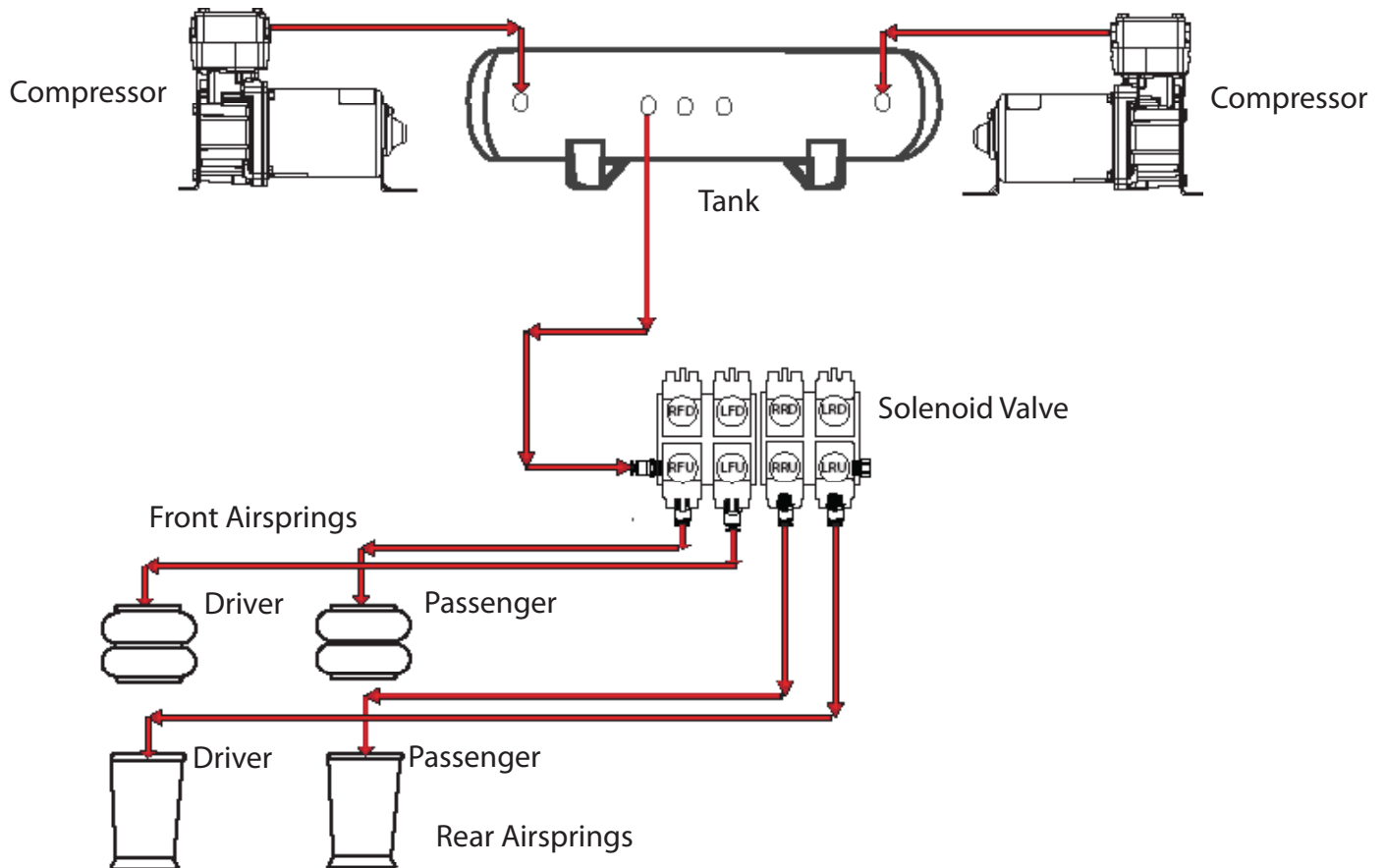

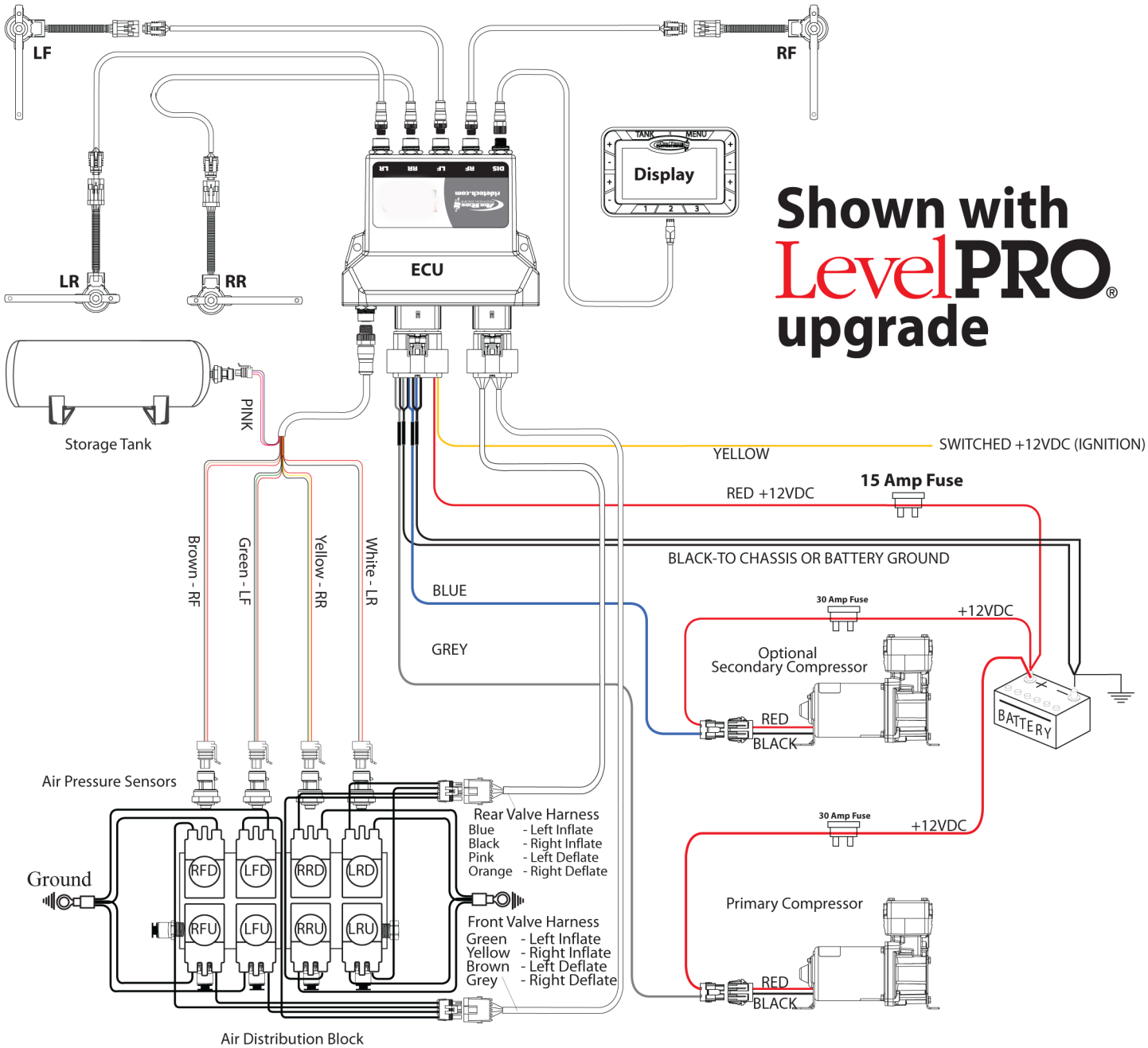

350 S. St. Charles St. • Jasper, IN 47546 • 812-481-4969