



Thank you for choosing a Ridetech air suspension control system. We are committed to providing the best experience possible throughout the process of getting your car on air.

Our commitment doesn't end with your purchase, in fact, it has only begun. This guide should provide you with the information you need to properly install and set-up your suspension control system.

However, if you find yourself having difficulty or if you have a question that isn't covered in this book, please call our tech department.

Tech Line: 812-481-4969

In addition to phone support, our website also provides a wealth of helpful product / install / set-up information.

Contents

Component Installation

Mounting compressor	2
Mounting tank.....	2
Mounting air valves	2
Routing air lines & fittings	3
Mounting pressure sensors.....	3
Mounting the controls & ECU.....	3
Wiring.....	3

Control Panel Features

Level Sensor Installation

Installing external ride height sensors.....	5
Connecting harnesses to ECU	5
Sensor rod assembly.....	6
Example installations	6

AirPod™ Installation

Mounting the unit	7
Wiring.....	7

System Control Options & Icons

Control Panel Users Guide

Calibration

Troubleshooting Guide

Tips and Tricks

Error Codes and Text

Plumbing Diagrams.....

Wiring Diagrams

Installing a RIDEPRO^{e5} System

STOP Remove the negative battery cable before beginning installation.



Mounting the Compressor

- All of our compressors are sealed for moisture and dust resistance so they can be mounted anywhere on the vehicle, though it is best to mount it in a place out of direct contact with rain and snow. It is OK to mount it underneath the vehicle, but keep it inside the frame rails away from water and debris thrown off the tire.
- This is a dry compressor; therefore it is maintenance-free and can be mounted in any position.
- It is best if mounted to something solid to reduce vibration and noise. If mounting it to sheet metal or the bed of a truck, use sound-deadening material between the compressor and the mounting surface.
- Use the rubber grommets supplied on the feet of the compressor to reduce vibration.
- Attach the grey wire from the main power harness to the black wire on the primary compressor. The red wire connects to +12V.
- Thomas Compressors (black) will require a 20 amp fuse (each).

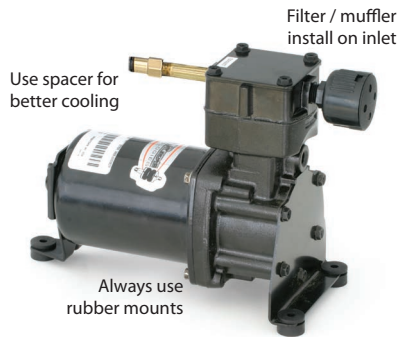

Mounting the Air Tank

- The air tank can be mounted anywhere on the vehicle in any position, so long as the sensor is not pointed down. Having the sensor mounted with the threads pointing up can cause damage to the sensor.
- There is an 1/8" port in the tank that will accept the tank pressure sensor.

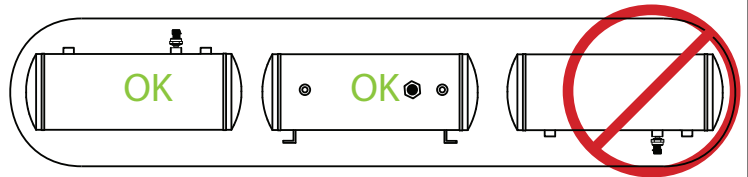

Mounting the RidePro Air Valves

- The valves, like the compressor, are sealed and can be mounted in the same locations. Although, if the vehicle will be exposed to freezing temperatures, it is a good idea to mount them in the engine bay if possible to reduce the possibility of freezing.
- They can be mounted in any position.
- Attach the ground strap to a good, clean ground (preferably the frame).
- The exhaust port will be left open.
- The valve is held closed with the pressure in the tank. If tank pressure drops below air spring pressure they will equalize, deflating all 4 air springs.

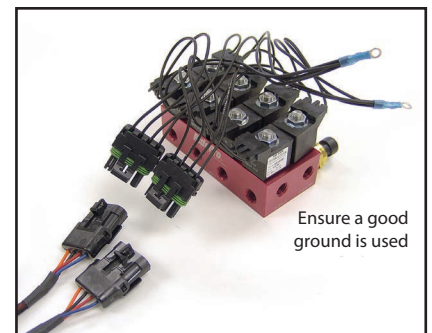

IF YOU ARE RUNNING A 2 COMPRESSOR SYSTEM, THE 2ND COMPRESSOR WILL NEED TO BE TURNED ON IN THE SETUP MENU! PAGE 9 WILL SHOW YOU WHERE TO TURN IT ON. YOU MAY GET ERROR #143 BEFORE YOU TURN COMPRESSOR #2 ON. IF YOU GET THIS ERROR, GO TO THE SETUP MENU AND TURN COMPRESSOR #2 ON. THE ERROR WILL CLEAR AFTER THE IGNITION IS CYCLED.

NOTE:

The RidePro system switches ground on the compressors; the compressors are provided power at all times.

IF YOU ARE RUNNING A 2 COMPRESSOR SYSTEM, THE 2ND COMPRESSOR WILL NEED TO BE TURNED ON IN THE SETUP MENU! PAGE 9 WILL SHOW YOU WHERE TO TURN IT ON.

Installing a RIDEPRO^{e5} System

Routing the Airline and Fittings

- Make all airline cuts with a razor or tubing cutter (part # - 90001081). The cut must be clean and straight or it will not seal.
- All fittings are DOT approved push-to-connect style. They are very simple to use and are reusable. Firmly push the airline into the fitting to attach. To release the airline push the collar on the fitting back towards the fitting and pull the airline out.
- **Use thread sealant on all fittings. The white compound that is on the fittings is an anti-gauling compound.**
- Do not over-tighten the fittings. This could result in breaking the fitting or damaging the air spring.
- All of our airlines are DOT approved so they are very strong, but keep them away from any sharp edges. Also, when passing through a hole in the frame use a grommet.
- Keep away from intense heat, including mufflers and exhaust manifolds.
- Use zip ties or other fasteners to secure the airline.

Use Tubing Cutter
(part # 90001081)
for straight ends.



Mounting the Air Pressure Sensors

- These sensors are voltage based and do not need to be grounded.
- Use thread sealant when installing pressure sensors in valve block.
- Sensors can not be pointed down (debris can collect and cause false readings)

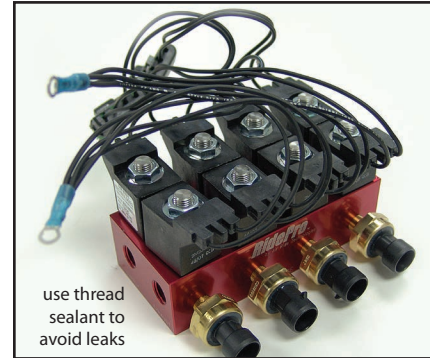

Mounting the ECU (Electronic Control Unit) & Control Panel

- The ECU is water proof and may be mounted in the engine bay or under the vehicle.
- The ECU is a wireless device, do not mount it fully enclosed by metal. Doing so will reduce the wireless range.
- The Display is **NOT** water proof and needs to be mounted inside the vehicle. It should be mounted in a location where it can be accessed with ease.
- The Display has a magnetic nameplate on the back of the display to aid in mounting.
- The orientation of the display can be changed to help tailor it to your install.
- Refer to Page 21 for a complete wiring diagram.

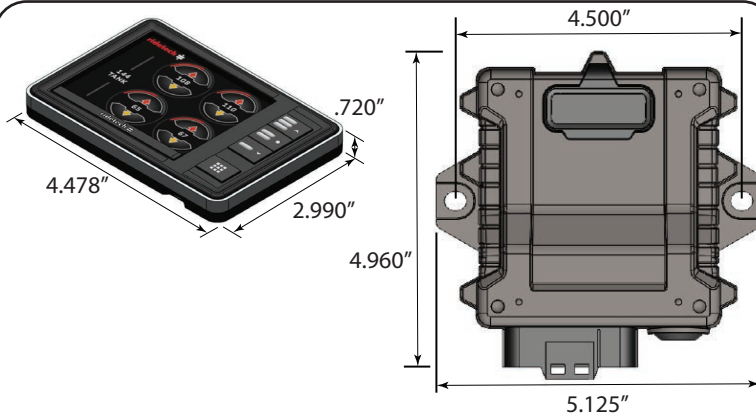

RIDEPRO^{e5}

Main Harness



Tank Pressure Sensor Harness



Pressure Sensors

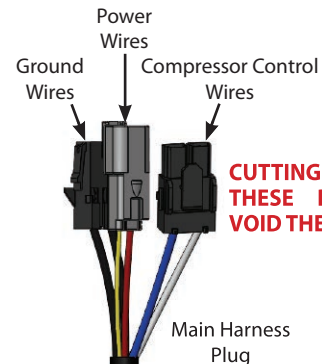

CUTTING OFF ANY OF THESE PLUGS WILL VOID THE WARRANTY.

- Black wire**
A clean chassis ground
- Yellow wire**
Ignition
(12 volts only when the key is on)
- Red wire**
Constant 12 volt
- Grey Wire**
Primary Compressor Ground
- Blue Wire**
Secondary Compressor Ground (OPTIONAL)

Optional Height Sensor Upgrade Part # 3040036

Height Sensors & Harnesses



We offer extension harness options for the ride height sensors and tank pressure sensor.

- 12' - 31900065
- 15' - 31900066



RIDEPRO^{e5} Control Panel Features

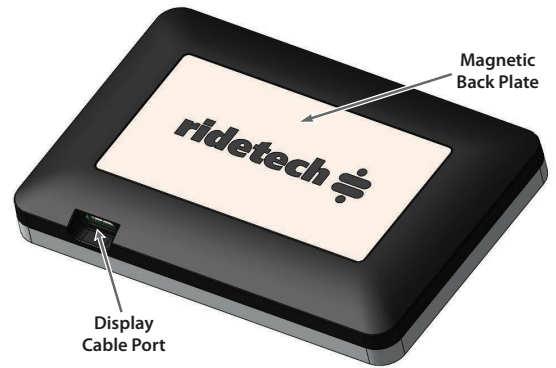
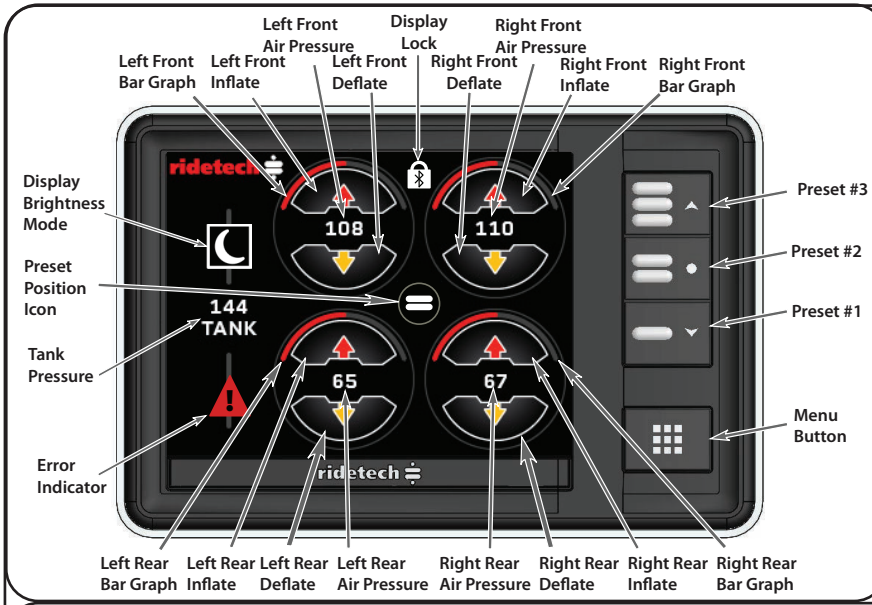

The rear panel of the display is magnetic to aid in mounting.

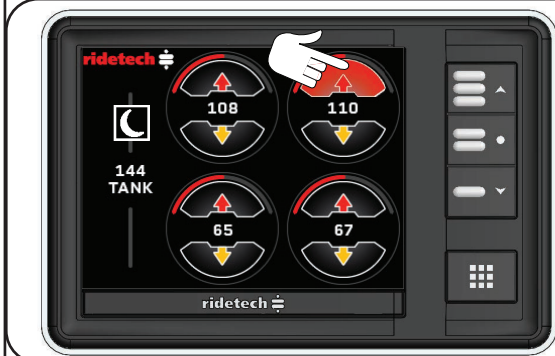

INFLATE & DEFLATE BUTTONS

You have full manual control at any time. To inflate an air spring simply press and hold the corresponding "▲" button. To deflate an air spring simply press and hold the corresponding "▼" button. The corresponding air spring will be inflated OR deflated until the button is released.

MAIN CONTROL SCREEN

The Main Control Screen displays information about the pneumatic suspension system including:

- individual pressure for each corner of the vehicle
- tank pressure
- preset indication
- bar graph for each corner. If the system is running in pressure only, the bar graph reflects the air pressure. If the system is equipped with optional ride height sensors, the bar graphs reflect the ride height sensor position.

The Main Control screen also allows adjustment of the following:

- manual control of individual corner air pressure/vehicle height
- preset selection
- system parameters and additional information via the Menu system

MANUAL CONTROL

The user has full manual control of inflating and deflating the system at all times.

Press a Red up arrow button to inflate the corresponding corner.

Press a Yellow down arrow button to deflate the corresponding corner.

Multiple buttons can be pressed simultaneously on the Display or Mobile APP.

Inflate and deflate buttons can be pressed simultaneously.

PRESETS

There are three user configurable Presets. The Presets can be saved to whatever vehicle height you wish. Typically Preset 1 is deflated vehicle height, Preset 2 is Ride Height, and Preset 3 is High Height.



= Deflated Setting



= Ride Height



= Inflated Setting

Presets are disabled until Calibration has been successfully completed.

After Calibration, presets can be saved by manually inflating or deflating the vehicle to the desired height, then pressing and holding a preset button for 5 seconds. A dialog screen will be displayed stating which preset has been saved.

RIDEPRO^{e5} Ride Height Sensors

External Ride Height Sensor Installation

- The Height Sensor Option uses 4 height sensors (one at each wheel). They are weather proof and may be mounted in any position as well as "clocked" in any position. (There is not a difference between the left and right sensors.) These sensors are typically mounted to the chassis / frame rail.
- A linkage with rubber ends connects the sensor arm and a suspension component. On most front suspensions, the linkage will attach to the upper or lower control arm. On most rear suspensions, it will attach to the axle or control arm.
- **The main goal when mounting the sensor is to achieve as much sensor rotation as possible without exceeding the sensors limits.**
- Although the sensor arm will rotate 180 degrees, it must remain in the middle 90 degrees throughout suspension travel. See diagram below for sensor travel limits.
- It may be necessary to shorten the sensor arm and drill a new hole to ensure the arm is rotating enough during suspension travel to accurately determine vehicle height.
- The sensor arm can also be removed from the sensor and clocked in four different positions. It may also be necessary to bend the sensor arm and/or linkage to achieve proper clearance and alignment.
- The sensor will be mounted to the frame using 1/4" self tapping screws or bolts. A special shouldered bolt is supplied to attach the rubber rod ends to the suspension and the sensor arm; this will avoid over tightening.
- Make sure the sensor has adequate clearance from all suspension components throughout suspension travel. Check tire clearance, lock to lock and throughout suspension travel.

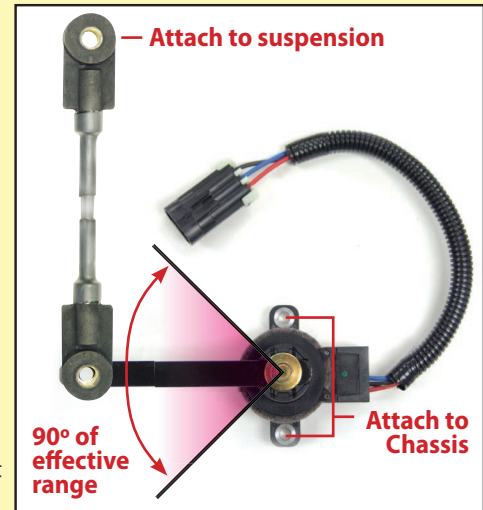

Travel Limits

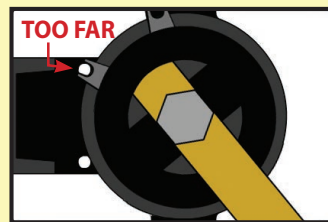
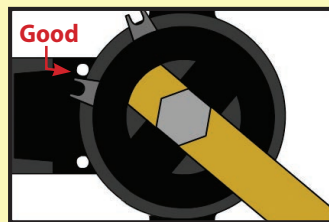
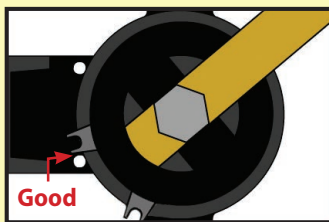

- ⚠ If the electrical range of travel is exceeded, the system may function erratically or not at all.
- ⚠ Also note that if the sensor has very little travel, the system may not perform to its potential.
- ⚠ It may be necessary to shorten the sensor arm to increase travel.

Connecting Sensor Harnesses to ECU

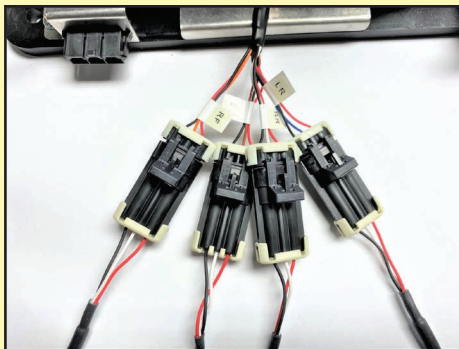

Run the harness from the sensors to the Main Harness (AirPod). We recommend marking the harnesses at the end that will plug in at the Main Harness (AirPod). The 4 plugs in the Main Harness are labelled for each corner. Plug the correct harness into each plug.

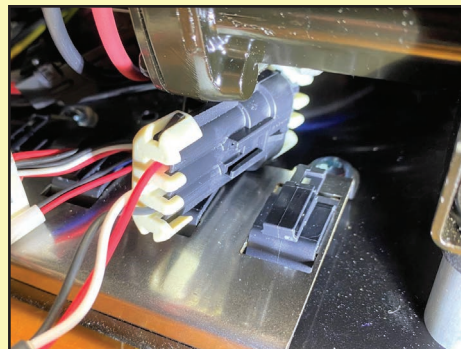

AIRPOD ONLY! The AirPod has 4 clips on the main board to secure the plugs for the level sensor harnesses. The female plug on the sensor harness will attach to these clips. The plug slides onto the clip from the release side of the clip.

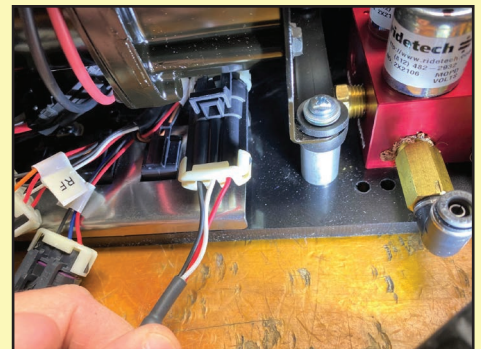

AIRPOD ONLY! Start the plug on the retainer and slid it until it clicks. This will lock the harness in place.

RIDEPRO^{e5} Ride Height Sensors

Assembly of the Sensor Link Rods



1- The linkage rod can be cut to length using side cuts.



2- The linkage rod can be bent by hand. This can come in useful when trying to get clearance on an obstacle.



3- After getting the linkage cut to length and shaped, line up the end with the end link.



4- Push the end of the linkage into the end link. The linkage doesn't require anything to hold it into the end link.

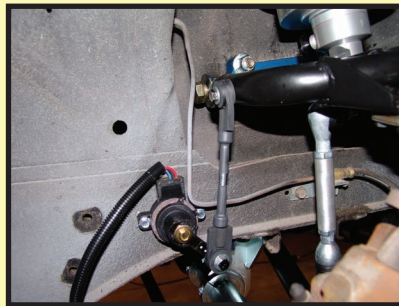

5- Once both sides of the linkage have been finished, secure the linkage to the sensor and suspension.

Sensor Mounting Examples

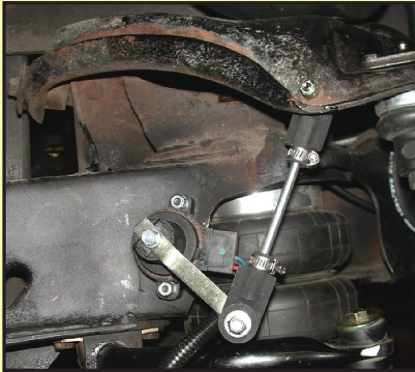

69 Camaro Front



Rear Trailing Arm

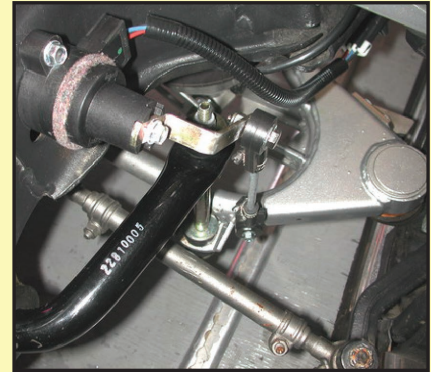

58-64 Impala Front

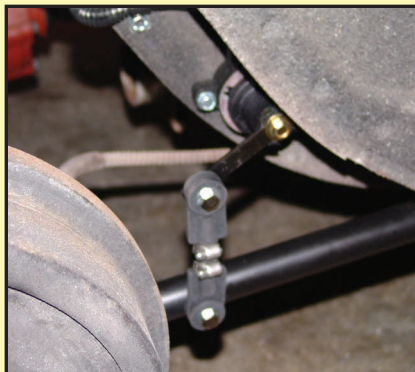

65-70 Mustang Rear



Triangulated 4-Link Rear



C-10 Truck Rear



Installing an AirPod

STOP Remove the negative battery cable before beginning installation.

MOUNT THE MAIN UNIT:

- 1- Mount the base flat to the vehicle surface (do not bend the base)
- 2- Secure the base with self-tapping screws or bolts.
- 3 - If optional cover is used, secure the cover to the airpod base using the supplied screws.

CONNECT AIR LINES:

- 1 - Airline cuts must be straight and clean - use a razor blade or tubing cutter. (part # - 90001081)
- 2 - All fittings are DOT-approved, reusable, push-to-connect style. Firmly push the airline into the fitting to attach. To release the airline, push the collar on the fitting back towards the fitting and pull the airline out.
- 3 - All of our airlines are DOT-approved so they are very strong. Secure the airline with zip ties, keep them away from any sharp edges, and when passing through a hole in the frame, use a grommet.
- 4 - Keep away from intense heat including mufflers and exhaust manifolds.

CONNECT POWER HARNESS:

- 1 - Connect the red power wire directly to the battery.
Use included fuse within 18" of battery.
3 Gallon - 30 amp fuse
5 Gallon - 40 amp fuse
- 2 - Connect the yellow ignition wire to switched 12v.
(Fuse Panel is the best location)
- 3 - Connect the black wire to chassis ground.

Be sure to use included fuse holder in the battery feed wire as close to the battery as possible.

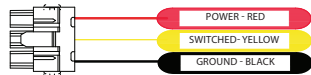

CAUTION: Use 8 gauge wire or larger to extend red power feed if needed

Required airline hookup.



RF LF RR LR

Power Harness Hookup



Display hookup

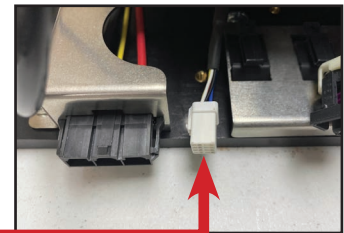

CONNECT THE DISPLAY/CONTROLS

See control programming and additional features section for more information on using the control panel.

CONNECT RIDE HEIGHT SENSORS

(if equipped):

See Ride Height Sensor section for more information on installing and calibrating height sensors.



AirPod Fuse Block

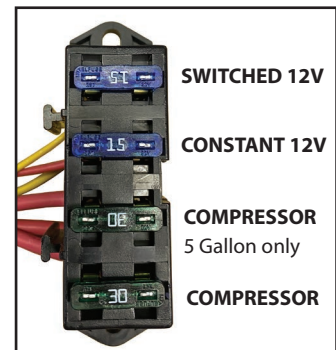

RIDEPRO^{e5} System Control Options & Icons

IF YOU ARE RUNNING A 2 COMPRESSOR SYSTEM, THE 2ND COMPRESSOR WILL NEED TO BE TURNED ON IN THE SETUP MENU! PAGE 9 WILL SHOW YOU WHERE TO TURN IT ON. YOU MAY GET ERROR #143 BEFORE YOU TURN COMPRESSOR #2 ON. IF YOU GET THIS ERROR, GO TO THE SETUP MENU AND TURN COMPRESSOR #2 ON. THE ERROR WILL CLEAR AFTER THE IGNITION IS CYCLED.

System Control

This system can be controlled 2 ways; Display & Mobile App (**SYSTEM DOES NOT REQUIRE CELL SERVICE TO WORK**). This section will cover all control options.

The RidePRO e5 will need to have gone through setup before the presets will work.

Display & Mobile App.

- system setup can be completed with either of the 2 devices
- 4-corner manual control at any time. **THE SYSTEM DOES NOT NEED TO BE CALIBRATED TO USE MANUAL CONTROL!**
- allows the user to select from any of the 3 presets
- system options can be changed
- pressure (standard) and height sensor (optional height sensors) displayed
- tank pressured displayed
- system errors can be viewed
- works only with the ignition on

The system control is the same between the 2 devices with the only difference being the ability to link a smartphone to the ECU using the control panel.

ERROR ICON



This icon is displayed on the main screen when the system sees an error. You can see what errors you have by going to "Errors" in the main menu.

PRESET POSITION ICON



These icons are displayed on the main screen when the system is at a preset height. It will be either position 1, 2, or 3. If no icon is displayed, the system is not at a preset height.

GOING TO PRESET POSITION ICON



These icons are displayed on the main screen when the system is going to a preset height. It will be either position 1, 2, or 3. You can cancel out of "going to preset" by selecting the "X" on the screen.

DISPLAY LOCKED ICON



This icon is displayed on the main screen when the display is locked. The lock mode can be deactivated by pushing the "Menu" button. The display will automatically lock after no buttons have been pushed for 30 seconds.

DISPLAY LOCKED - BLUETOOTH IN USE ICON



This icon is displayed on the main screen when the system is connected to a phone using the app. This prevents the system from being controlled from the display while it is being controlled with a phone. Closing the app will unlock the Bluetooth lock.

DISPLAY DAY TIME MODE ICON



This icon is displayed on the main screen when the system is in "Night Mode". Touching the icon will put the display in day time mode. When the display is in night mode, it will be dimmer. The brightness of the display in night mode can be adjusted in the main menu.

DISPLAY NIGHT TIME MODE ICON



This icon is displayed on the main screen when the system is in "DAY Mode". Touching the icon will put the display in night time mode. When the display is in day mode, it will be brighter. The brightness of the display in day mode can be adjusted in the main menu.

HOME



This icon is displayed on the menu screen when in the system menu. Touching the icon will return you to the main control screen.

BACK



This icon is displayed on the menu screen when in any selection from the main menu. Touching the icon will return you to the main menu screen.

RIDEPRO^{e5} Control Panel Users Guide



The Menu provides the ability to adjust system parameters to meet an individual's tastes, as well as displaying useful information. One may exit the Menu at any time by pressing either the "Home" button or "Menu" button.

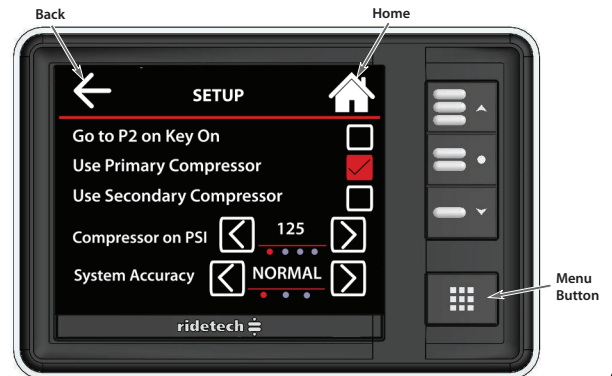
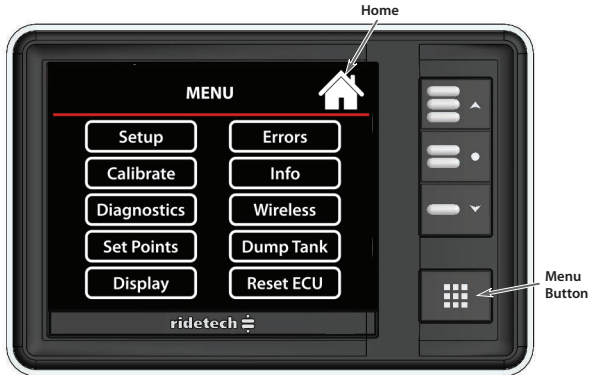

Setup

The Menu Setup screen contains the basic operating parameters of the system.

Go To P2 on Start:

By choosing Yes, the vehicle will return to Preset #2 whenever the ignition is cycled. This is typically used to set the vehicle back to Ride Height anytime the vehicle is started. **FACTORY DEFAULT IS "OFF".**

Use Primary Compressor:

Selecting Yes here enables control of the primary air compressor. **FACTORY DEFAULT IS "ON".**

Use Secondary Compressor:

Selecting Yes here enables control of the secondary air compressor. **FACTORY DEFAULT IS "OFF"; IT WILL NEED TO BE SWITCHED TO "ON" IF YOU ARE RUNNING 2 COMPRESSORS! YOU MAY GET ERROR #143 BEFORE YOU TURN COMPRESSOR #2 ON. IF YOU GET THIS ERROR, GO TO THE SETUP MENU AND TURN COMPRESSOR #2 ON. THE ERROR WILL CLEAR AFTER THE IGNITION IS CYCLED.**

Compressor on PSI:

This allows one to select at what pressure the compressor will be turned on. By default, the system turns the compressor on when the tank pressure drops below 135psi. **FACTORY DEFAULT IS "135".**

System Accuracy:

This allows one to adjust how accurately the system reaches presets. Though High Accuracy will reach preset values extremely closely, it may take longer than one desires. In this case, one could choose Standard or Medium accuracy, which will allow the system to reach the preset destination quicker, but the physical height of the vehicle may be slightly off from the preset values. By default, the system is set to Medium Accuracy.

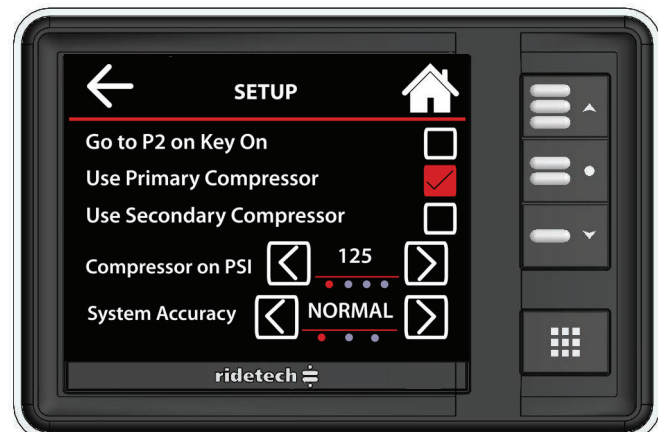

RIDEPRO^{e5} Control Panel Users Guide



Set Points

The Menu Set Points screen displays the saved Preset set points of each corner of the vehicle, as well as the current values for each corner.

If the system is running in air pressure only mode, it will automatically display pressure (psi).

If the system is running in air pressure and height sensor mode (**with optional Ride Height Sensors**), it will automatically display level sensor voltage.



You can see each preset by selecting the corresponding ,  or  button.

Reset ECU

The Reset ECU screen allows you to clear the ECU and return it to the factory defaults. The Reset ECU option has a 2 layer verification to prevent you from accidentally resetting the ECU. It is necessary to select OK on each screen to reset the ECU. If you select the OK two times, all calibration and preset data is erased.



If you reset the ECU, you will have to rerun calibration!

RIDEPRO^{e5} Control Panel Users Guide

Diagnostics

- CONTROL PANEL & MOBILE APP

The Menu Diagnostics screen can be used to diagnose problems/issues, specifically with the level sensor positioning during installation and/or the vehicle charging system.

Each corner can be manually inflated and deflated via the buttons surrounding the read out screen.

The readout screen displays the pressure and level sensor voltage (IF USING RIDE HEIGHT SENSORS) of each corner as well as the battery voltage in real time.

The top image is RidePRO E5 without ride height sensors.

The bottom image is RidePRO E5 with ride height sensors. If you have ride height sensors, it will display the voltage output of the level sensors. The range of the level sensors is 0.5 - 4.5 volts.

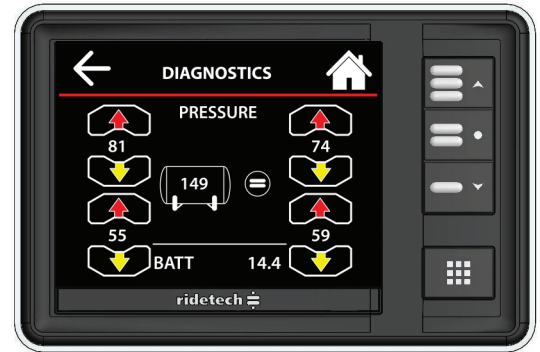

Dump Tank

The Menu Dump Tank screen provides a simple and easy way to completely drain an air storage tank for servicing or storage.

The Dump Tank feature requires a 2 step verification for safety. You will have to "OK" the choice 2 times for the system to dump the air tank. This is a safety feature to prevent the air tank from being dumped accidentally.

When the OK button is pressed all valves are opened, which exhausts the air from the tank to atmosphere. The compressors are disabled so the tank is not filled during this procedure.

The valves will remain open until tank pressure reaches 0 psi.

The compressors will remain disabled until the ignition is turned off then back on.

Dump Tank has a secondary screen to verify you want to dump the tank.



RIDEPRO^{e5} Control Panel Users Guide

Display

The Menu Display screen allows you to control the brightness settings of the day and night modes. It also allows you to change the orientation of the control panel.

BRIGHTNESS ADJUSTMENT

The Day and Night settings are adjustable independently of each other. Make adjustments by selecting the icon for the one you want to adjust. The icon you select will be red on the screen. Adjust the brightness up and down by using the + & - icons.

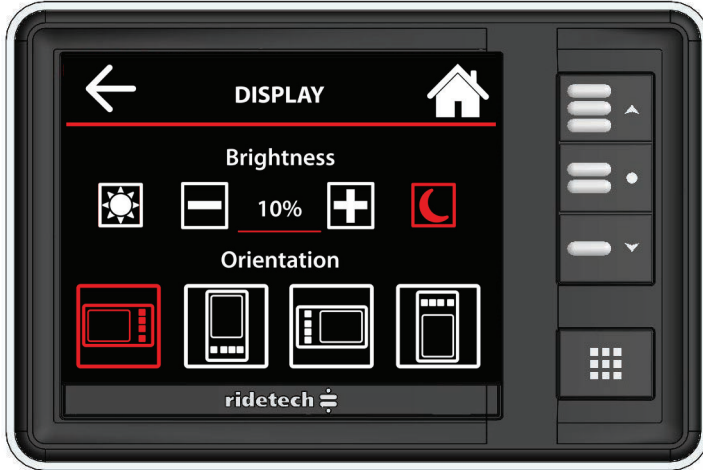

DISPLAY ORIENTATION

The orientation of the display can be changed. The orientation you select will be red on the screen. Each icon shows the position of the preset buttons. Touch the button that represents how you would like your display oriented. All 4 choices are demonstrated with these images.

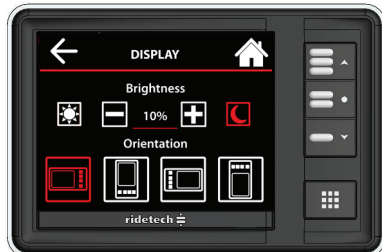

PRESET BUTTONS RIGHT
Default Setting

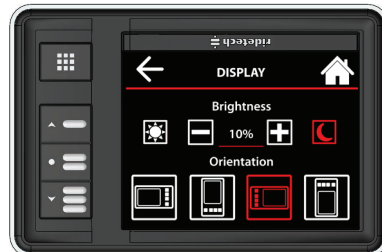

PRESET BUTTONS LEFT



PRESET BUTTONS DOWN



PRESET BUTTONS UP

Info

The Menu Info screen displays information about the control system including:

Firmware: software version of the ECU & Display

ECU Boot: boot loader version of the ECU

ECU HW: hardware version of the ECU

Power Cycle: number of times the switched power has been turned on/off since the main power was connected

App Version: version of the mobile application

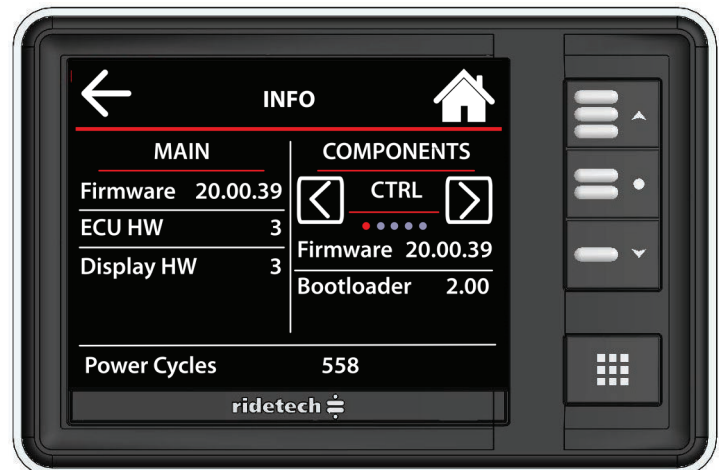

RIDEPRO^{e5} Control Panel Users Guide

Errors

The Menu Error History screen displays any errors that have occurred, as well as the ignition cycle during which they occurred.

You can see what power cycle the system is currently on by going to the info screen.

Pages 18 & 19 have a complete list of the systems error codes along with solutions.

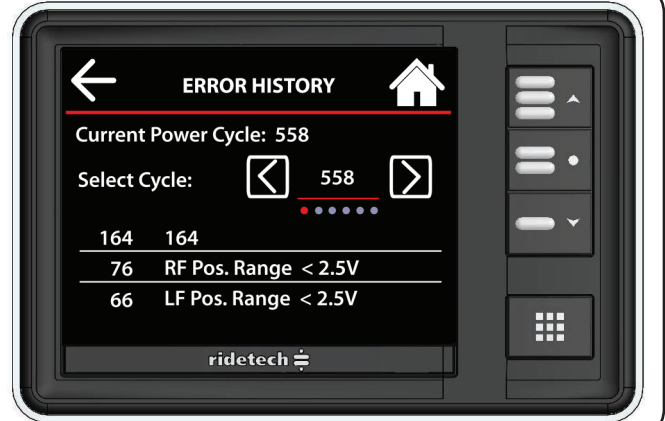

Calibrate

The Menu Calibration screen allows the user to calibrate the system.

Though Calibration is not required for manual control of the system, Calibration is required to enable functionality of the Presets. During Calibration, the system learns specific characteristics of the vehicle into which it is installed. This information is used by the system to accurately and efficiently reach preset destinations.

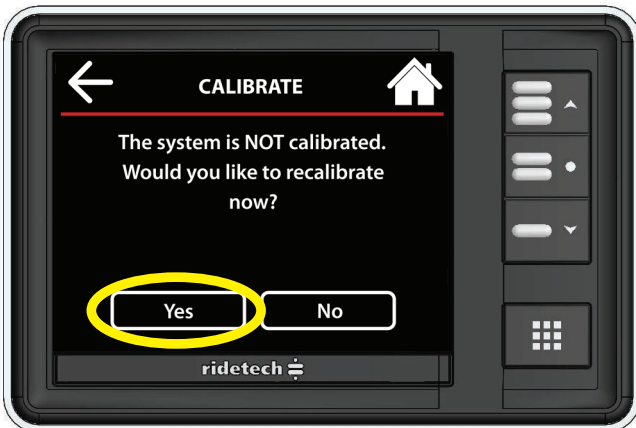

Make sure nothing is under the vehicle before performing calibration. To Calibrate the system, select "Yes".

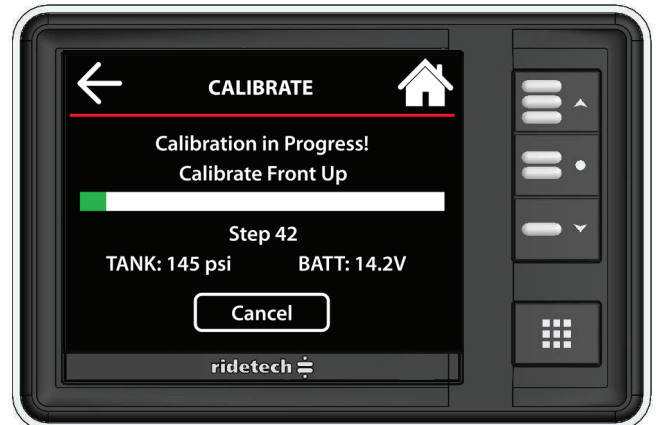

The system will tell you what it is doing throughout the calibration process.

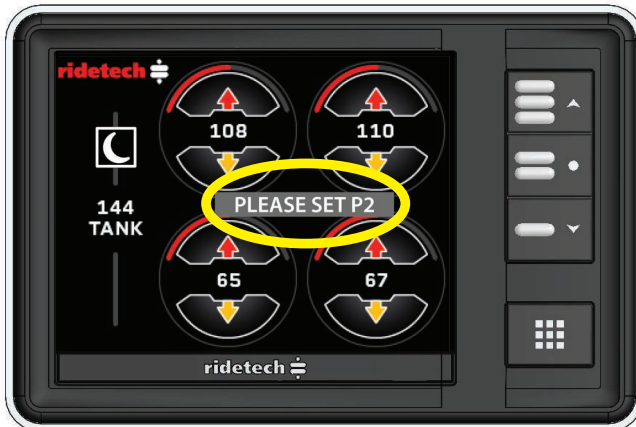

This screen will pop up after the system is calibrated. Use the Manual Up & Down Buttons to set your ride height. After you get your ride height set, hold the #2 for 5 seconds.



"P2 Set" will pop up, select "OK".

If you are not running level sensors, you will need to program all 3 presets.

Calibration

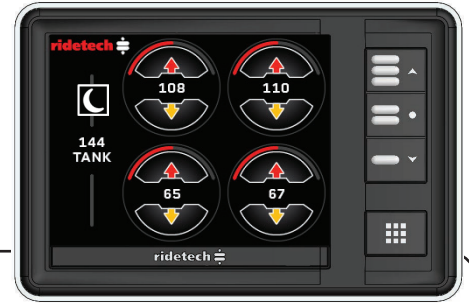

DO NOT RERUN CALIBRATION ON A SYSTEM THAT HAS BEEN PREVIOUSLY CALIBRATED. IF YOU ARE HAVING A PROBLEM WITH THE SYSTEM, TRYING TO RECALIBRATE WILL MAKE IT DIFFICULT TO DIAGNOSE THE PROBLEM.

Calibration:

!ATTENTION!!!! The vehicle **MUST** be running in order to calibrate this system!

Only turning the key on will **NOT** work!

Hooking it to a battery charger will **NOT** work!

The vehicle must be running!

During the Calibration sequence, the RidePRO e5 records information specific to the vehicle in which it is installed (inflate and deflate speed, if level sensors are present, how long the compressors take to fill the storage tank, etc.) The RidePRO e5 then uses this information to attain the proper preset heights in the fewest possible steps, using the most intelligent method. For example, after calibration the RidePro knows that the front of the vehicle is heavier and therefore slower than the rear, so it will inflate the front first then allow the rear to catch up just as the vehicle is achieving ride height.

NOTE: The RidePRO e5 system is a very intelligent system. Attempting to calibrate this system on a non-running vehicle will cause errors. Trying to hook the system up for a "TEST RUN"? When the system is powered up, it will work manually using the inflate and deflate buttons only. The preset buttons will not work until calibration is complete. **Calibration should not be run until vehicle is running and driving.**

NOTE:

Target on pressure based systems is + or - 7 PSI
Target on height based systems is + or - 1/4"

PRESSURE BASED CALIBRATION (No Level Sensors)

Calibration Steps: (items in red require user interface, other steps are automatically completed)

These steps will require the car to be running to ensure full battery voltage!

1. Start the vehicle
2. Allow the compressor/compressors to fill the tank (They will shut off @ 150psi)
3. Touch the MENU button to bring up the menu
4. Select the CALIBRATE button
5. Checking pressure sensors - locates and checks the air spring pressure sensors
6. Calibrate front up - sets the upper limit of suspension travel
7. Calibrate front down - sets the lower limit of suspension travel
8. Calibrate rear up - sets the upper limit of suspension travel
9. Calibrate rear down - sets the lower limit of suspension travel
10. System will return to the main screen, at this point you will need to set your 1,2,3 positions.
11. Do the #1 since the vehicle is already deflated. Hold #1 for 5 seconds or until the screen reads "P1 Saved". Select "OK" to return to the main screen.
12. Set your desired ride height and hold #2 until "P2 Saved" pops up. Select "OK".
13. Raise the vehicle to the extended height, hold #3 until "P3 Saved" pops up, Select "OK"
14. Calibration complete
15. Cycle the vehicle's power by turning off the key. On an newer vehicle, you may have to open the door to kill the power to the system.

IF YOU ENCOUNTER ANY ERRORS DURING CALIBRATION, REFER TO THE ERROR CODES ON PAGES ON PAGES 18 & 19 TO HELP YOU TROUBLESHOOT THE ERROR.

PRESSURE AND HEIGHT CALIBRATION (with Level Sensors)

Calibration Steps: (items in red require user interface, other steps are automatically completed)

These steps will require the car to be running to ensure full battery voltage!

1. Start the vehicle
2. Allow the compressor/compressors to fill the tank (They will shut off @ 150psi)
3. Touch the MENU button to bring up the menu.
4. Select the CALIBRATE button.
5. Checking pressure sensors - locates and checks the air spring pressure sensors.
6. Checking position sensors - locates and checks the level sensors
7. Calibrate front up - sets the upper limit of suspension travel
8. Calibrate front down - sets the lower limit of suspension travel
9. Calibrate rear up - sets the upper limit of suspension travel
10. Calibrate rear down - sets the lower limit of suspension travel
11. "Set P2" on main screen - set the vehicle to your desired ride height and hold #2 for 5 seconds
12. Calibration complete- select the "OK". Display will return to the Main Screen.
13. Cycle the vehicle's power by turning off the key. On an newer vehicle, you may have to open the door to kill the power to the system.

IF YOU ENCOUNTER ANY ERRORS DURING CALIBRATION, REFER TO THE ERROR CODES ON PAGES ON PAGES 18 & 19 TO HELP YOU TROUBLESHOOT THE ERROR.

DO NOT RERUN CALIBRATION ON A SYSTEM THAT HAS BEEN PREVIOUSLY CALIBRATED. IF YOU ARE HAVING A PROBLEM WITH THE SYSTEM, TRYING TO RECALIBRATE WILL MAKE IT DIFFICULT TO DIAGNOSE THE PROBLEM.

RIDEPRO^{e5} Troubleshooting Guide

RidePRO e5 will not turn on.

Diagnosis: No LED light on top of ECU

Solution: Check RED wire for constant 12 volts, YELLOW wire for 12 volts with key ON, and the 2 fuses in ground wires from ECU. Also, verify that you have a good ground on the 2 ground wires.

Compressor will not turn on.

Diagnosis A: Check Setup Menu to ensure compressor(s) is turned on.

Solution A: Select the box to make sure it turns red with a check mark.

Diagnosis B: 12 volts not present at Red wire on compressor.

Solution B: Check fuse and connections. (20 amp fuse on Thomas compressor)

Diagnosis C: 12 volts present at Red wire on compressor but still doesn't run.

Solution C: Check connections between Black wire on compressor and Blue/Gray wire on ECU. **Also check FUSES in Black wire from ECU to Ground.**

Diagnosis D: 12 volts present at Red wire on compressor but still doesn't run.

Solution D: The compressor has gotten hot and thermals out. The air compressors have a thermal safety built in. If the compressor gets too hot, it will shut itself off. Let the compressor cool, it should come back on.

Compressor will not turn off.

Diagnosis A: Tank pressure reads 0 psi all the time or stays at the same pressure regardless of actual tank pressure.

Solution A:

1. Check harness and plugs.
2. Replace pressure sensor.

Diagnosis B: Tank pressure builds normally but will not reach 150psi.

Solution B: Replace compressor.

One air spring leaks down over a period of time.

Diagnosis A: Leak between delivery port on valve block and air spring. ALL FITTINGS NEED SOME KIND OF THREAD SEALER.

Solution A: **Air springs almost never leak. Spray all fittings with soapy water. Tighten fitting and/or remove and replace thread sealant. Cut 1" off of end of airline and reinsert.**

Diagnosis B: Exhaust valves leaking. Air seeps past exhaust valve and out exhaust port.

Solution B: Usually caused by debris stuck on valve seat. Inflate and deflate several times or disassemble valve. Information about servicing the valves can be found at: <https://www.ridetech.com/tech/solenoid-valve-service/>

One air spring leaks up over a period of time.

Diagnosis A: Inflate valves leaking. Air seeps past inflate valve and into air spring.

Solution A: Usually caused by debris stuck on valve seat. Inflate and deflate several times or disassemble valve. Information about servicing the valves can be found at: <https://www.ridetech.com/tech/solenoid-valve-service/>

The 2 front or all 4 air springs leak down over a period of time.

Diagnosis A: Check tank pressure. There is a leak in the supply side of the system. This could be at the compressor, tank, or supply ports on the valve. **The valves are held closed by the tank pressure.** If the tank pressure gets below the air spring pressure, the air spring will leak down with the tank. An easy way to check this; make sure the compressor runs until it shuts off. Write down the tank pressure and let the vehicle sit over night. If the compressor kicks on right away the next time you turn on the system, you have a leak on the supply side of the system.

Solution A: **Spray all fittings with soapy water. Tighten fitting and/or remove and replace thread sealant. Cut 1" off of end of airline and reinsert.**

Control panel switches activate the correct air spring, but the air pressures read the wrong air spring.

Diagnosis: Ex: Inflating the RF air spring changes the top left psi readout on the panel

Solution: Swap pressure sensor harnesses at the sensors.

Pressure readings are not moving, always reads 168 psi or 0 psi.

Diagnosis: ECU is not receiving a proper signal from the sensor.

Testing: Switch the wires between two sensors, if the corner you switched it with now reads zero, you have a bad sensor.

Solution:

1. Check pressure sensor harness connections.
2. Replace sensor.

Height sensor bars read the incorrect corner.

Diagnosis: Ex: When inflating RF air spring LF bar increases

Solution: Swap height sensor harnesses at ECU.

RIDE PRO^{e5} Troubleshooting Guide

Control panel switches do not activate the correct air spring.

Diagnosis: Ex: LF switch actuates the RF air spring.

Solution: Swap airline at the valve block.

Presets work, but does not achieve target.

Diagnosis A: Air tank is too small. Air spring pressure equalizes with tank pressure before achieving preset pressure/height.

Solution A: Reprogram #1 preset for the highest psi that allows the suspension to bottom out. You do NOT need to let all of the air pressure out of the air springs. Let the air out of each end of the vehicle until it stops moving. This should be your #1 setting. You will likely have air pressure left in the air springs. This will give it a "head start". If this does not fix the issue, you need a larger air tank. A larger vehicle should always have a 5 gallon air tank.

Diagnosis B: Tank pressure leaks down.

Solution B: Fix leak on supply side of system.

Diagnosis C: Pressure sensors and/or airline are not attached to corresponding air spring.

(Ex: RF button must activate RF air spring and top right number on display.)

Solution C: Swap airline at delivery port on valve and/or air pressure sensor harness.

Diagnosis D: Mechanical height sensors are out of range. Under "System Setup" check the presets voltages. If one or more are at 4.5v or .5v then the sensor is traveling beyond its range of travel.

Solution D: Reduce or change travel of sensor by either changing linkage length, changing sensor arm length or by rotating sensor.

Low voltage error.

Low Voltage Error is triggered if the system sees under 10.5 volts for an extended period of time. It will turn the compressors off to prevent the battery from being drained. The compressors will come back on after the battery voltage increases and stabilizes.

Solution A: Make sure the vehicle is running.

Solution B: Check all of your connections at the grounds and battery.

Solution C: If it is a common occurrence, you may need a larger alternator.

One corner will not inflate or deflate, but the others inflate and deflate.

Diagnosis A: With the vehicle running, check to see if the valve clicks when the button is pushed.

Solution A: If no click, check the harness going to valves and the grounds at the valve block.

Diagnosis B: With the vehicle running, check to see if the valve clicks when the button is pushed.

Solution B: If no click, check the grounds at the valve block. You can also test the wire of the coil of the solenoid that isn't working. Each coil of the valve block has 2 wires. One wire is ground, the other wire is the control wire. You should see 12 volts on this wire when the button for the solenoid is pushed. Use a volt meter on this wire to see if you have 12 volts when the button is pushed.

Diagnosis C: With the vehicle running, check to see if the valve clicks when the button is pushed.

Solution C: If valve clicks, but does not open. The plunger in the valve is can be badly dimpled and needs replaced. If the plunger is badly dimpled, it can get stuck in the hole in the valve, not allowing it to open. Information about servicing the valves can be found at: <https://www.ridetech.com/tech/solenoid-valve-service/>

Diagnosis D: System is getting LOW voltage.

Solution D: Start the vehicle and test to see if you are getting at least 12.5 volts at the battery. A battery charger isn't enough to run the system.

All pressure readings 0 psi.

Diagnosis: 5 volt is shorted to ground.

Testing: Verify that the pressure sensors are plugged into the harness and there is pressure in the system.

Solution: 1. Check the pressure and level sensor harness to see if there is a short to ground or the harness has an internal short. This could be at a spot where the harness passes through metal or if the harness has been pinched.

Vehicle not obtaining correct height when going to a preset.

Diagnosis: Vehicle is not at the height you initially programmed.

Solution: This is a learning system, the more you use it, the more accurate it will get.

DO NOT RERUN CALIBRATION ON A SYSTEM THAT HAS BEEN PREVIOUSLY CALIBRATED. IF YOU ARE HAVING A PROBLEM WITH THE SYSTEM, TRYING TO RECALIBRATE WILL MAKE IT DIFFICULT TO DIAGNOSE THE PROBLEM.

RIDEPRO^{e5} Tips & Tricks

DO NOT RERUN CALIBRATION ON A SYSTEM THAT HAS BEEN PREVIOUSLY CALIBRATED. IF YOU ARE HAVING A PROBLEM WITH THE SYSTEM, TRYING TO RECALIBRATE WILL MAKE IT DIFFICULT TO DIAGNOSE THE PROBLEM.

When inflating and deflating the vehicle manually, push both buttons for one end of the vehicle at the same time.

Explanation: When you do one corner at a time, it is harder to get the vehicle level at the height you are trying to achieve. By pushing both inflate buttons at the same time, each side of the vehicle works together to lift the vehicle. When you get close to the height you are trying to obtain, then you can adjust the air in each corner individually.

Pressure differential from side to side.

Explanation: It is not uncommon for a vehicle to have more pressure in one side. Several things can affect the air pressure from side to side; weight distribution and chassis twist are the two most common causes. Airing up both front or both rear at the same time will help get the vehicle closer to level than trying to do it one corner at a time. A 10-15 psi differential from one side to the other is not uncommon.

Tip: After you have leveled the vehicle, take a look at all 4 pressures. If two corners opposite of each other are your higher pressures, you may be cross loading the vehicle. Example: The Left Front has a higher pressure than Right Front and Right Rear has a higher pressure the Left Rear, there's a good chance the 2 higher pressure air springs are pushing against each other. Try getting the pressures closer to the opposite side of the vehicle on each end and see how the vehicle sits.

Swapping airlines to help diagnose a problem.

Explanation: Air lines can be swapped from one port to another to help diagnose a problem. This can help you narrow down where a problem may be.

Example: Right rear will not air up, but left rear will - switch the right rear and left rear air lines. The operation of the rear will now be switched at the control panel, but the air pressures will still be correct for the corners. If the right rear will still not air up using the left rear button, your problem is somewhere from the right rear valve to air spring. If the right rear will now air up using the left rear button, the problem is in the wiring controlling the valve.

Swapping pressure sensors harness plugs to help diagnose a problem.

Explanation: Pressure harnesses and sending units can be swapped from one port to the another to help diagnose a problem.

Example: Right rear pressure reading zero, but other corners reading correctly - switch the right rear pressure sensor harness with the left rear. Keep in mind, the rear pressures will now read backwards of each other. If the zero reading moves to the left rear, the sensor is bad or there is a problem in the wiring. If you move the sensor wires and now the left rear has a reading, there is probably no air in the right rear corner. Check your valve, air line, and air spring for the right rear.

Tip: You can also switch pressure sensors around to help determine if you have a bad sensor. Make sure you deflate the corners you are swapping to eliminate the pressure at the sensor. If you are removing the tank sensor, dump the tank before removing it. This can be done in the Menu.

Using the "Diagnostics" tab to help verify correct operation of the system.

Explanation: If you go to the "Diagnostics" tab under the "Menu", you can see all 4 corner pressure readings. If you have level sensors on your vehicle, you will also see level sensor voltage readouts. Battery voltage is also displayed on this screen.

Tip: If you operate one corner at a time, you can verify the correct corner of the vehicle is moving. The corner pressures (and level sensor voltages if equipped) should also be moving on the corner you are operating.



TECH TIP

SUSPENSION BIND

Ever noticed that when you lower any vehicle off of a lift or jack stands that it is sitting several inches higher than normal? This condition is due to Suspension Bind, and all vehicles have it. Three dynamics lead to suspension bind:

1. **Tire Scrub** - The arc created by the control arm swing will try to push your tires apart or pull them together, (basically changing the track width). However, friction between the tire and ground does not allow the tires to slide, reducing vehicle movement. This can be especially dramatic with sticky tires and concrete.
2. **Control Arm Bushing** - Friction between the bushing and the frame brackets will also reduce vehicle movement. This is why control arm bolts must be tightened at ride height. Over-tightening the bolts can lead to very excessive suspension bind.
3. **Shock Absorbers** - The shock absorber's job is to reduce suspension movement. The stiffer the shock absorber, the more suspension bind.

With an air suspension vehicle, it is always best to over inflate the air spring and then deflate back down to the target pressure to alleviate some suspension bind.

THIS SYSTEM IS EQUIPPED WITH SELF DIAGNOSTICS TO MAKE TROUBLESHOOTING A PROBLEM SIMPLE. PAGES 18 & 19 HAVE A LIST OF POSSIBLE TROUBLE CODES ALONG WITH TEXT TO HELP SOLVE THE PROBLEM. THE ERROR WILL POP UP ON THE DISPLAY WHEN IT OCCURS OR YOU CAN LOOK AT THEM UNDER THE ERROR TAB. WHEN USING THE ERROR TAB IN THE APP, IT ONLY GIVES YOU THE ERROR CODE NUMBER ALONG WITH THE KEY CYCLE. YOU WILL NEED THE LIST OF ERROR CODES TO SEE THE TEXT. THE KEY CYCLE CAN BE HELPFUL WHEN DIAGNOSING A PROBLEM. IF YOU SEE SEVERAL ERROR CODES ON THE SAME KEY CYCLE, THEY ARE ALL USUALLY CAUSED BY ONE MAIN ERROR THAT CAUSED THE OTHER ERRORS.

RIDEPRO^{e5} Control System Error Codes

PRESSURE SENSOR RELATED ERRORS

ERROR CODES AND TEXT	POSSIBLE ISSUE	SOLUTIONS
ERROR 11: LF PRESSURE LOW VOLTAGE ERROR 21: RF PRESSURE LOW VOLTAGE ERROR 31: LR PRESSURE LOW VOLTAGE ERROR 41: RR PRESSURE LOW VOLTAGE ERROR 51: TANK PRESSURE LOW VOLTAGE	Sensor is disconnected or sensor has failed.	Is the sensor harness plugged into the ECU? Is the sensor harness plugged into the sensor?
ERROR 12: LF PRESSURE HIGH VOLTAGE ERROR 22: RF PRESSURE HIGH VOLTAGE ERROR 32: LR PRESSURE HIGH VOLTAGE ERROR 42: RR PRESSURE HIGH VOLTAGE ERROR 52: TANK PRESSURE HIGH VOLTAGE	Wire harness damaged or sensor has failed.	Is there +5 volt on the red wire at the sensor? Is there ground on the black wire of the sensor?
ERROR 13: LF PRESSURE NO MOVEMENT ERROR 23: RF PRESSURE NO MOVEMENT ERROR 33: LR PRESSURE NO MOVEMENT ERROR 43: RR PRESSURE NO MOVEMENT	Sensor improperly installed or has failed. THIS ERROR CAN ALSO BE CAUSED BY THE VALVES NOT OPENING, CHECK CONNECTIONS AT THE VALVE BLOCK.	Is any of the sensor wires shorted to ground? If one of the 5 volt sensor wires is shorted to ground, all pressures will read zero. Find and fix bad wire.
ERROR 14: LF PRESSURE WRONG LOCATION ERROR 24: RF PRESSURE WRONG LOCATION ERROR 34: LR PRESSURE WRONG LOCATION ERROR 44: RR PRESSURE WRONG LOCATION	Sensor plugged into wrong location.	Reconnect sensor following on-screen prompts. Inflate each corner separately to verify the air pressure changes on the correct corner and that you also have suspension movement on the correct corner.

POSITION SENSOR RELATED ERRORS

ERROR CODES AND TEXT	POSSIBLE ISSUE	SOLUTIONS
ERROR 61: LF POSITION LOW VOLTAGE ERROR 71: RF POSITION LOW VOLTAGE ERROR 81: LR POSITION LOW VOLTAGE ERROR 91: RR POSITION LOW VOLTAGE	Sensor is disconnected or sensor has failed.	Is the sensor harness plugged into the ECU? Is the sensor harness plugged into the sensor? Is the sensor linkage arm connected to the sensor?
ERROR 62: LF POSITION HIGH VOLTAGE ERROR 72: RF POSITION HIGH VOLTAGE ERROR 82: LR POSITION HIGH VOLTAGE ERROR 92: RR POSITION HIGH VOLTAGE	Wire harness damaged or sensor has failed.	Is the sensor linkage arm connected to the vehicle? Does the sensor move with suspension movement?
ERROR 63: LF POSITION NO MOVEMENT ERROR 73: RF POSITION NO MOVEMENT ERROR 83: LR POSITION NO MOVEMENT ERROR 93: RR POSITION NO MOVEMENT	Sensor improperly installed or has failed.	
ERROR 64: LF POSITION WRONG LOCATION ERROR 74: RF POSITION WRONG LOCATION ERROR 84: LR POSITION WRONG LOCATION ERROR 94: RR POSITION WRONG LOCATION	Sensor plugged into wrong location.	Reconnect sensor following on-screen prompts. Inflate each corner separately to verify the sensor voltage changes on the correct corner. This can be done in the Diagnostics Tab.
ERROR 65: LF POSITION RANGE (less than 1V) ERROR 75: RF POSITION RANGE (less than 1V) ERROR 85: LR POSITION RANGE (less than 1V) ERROR 95: RR POSITION RANGE (less than 1V)	Max-Min must be over 1V for proper system operation. Go to Menu/Diagnostic; Fully deflate the vehicle. Record min sensor voltages. Fully inflate the vehicle. Record max sensor voltages. Subtract Max from Min. Is it over 1V change? If not, readjust sensor. 2.5V or more is optimal.	
WARNING 66: LF POSITION RANGE (less than 2.5V) WARNING 76: RF POSITION RANGE (less than 2.5V) WARNING 86: LR POSITION RANGE (less than 2.5V) WARNING 96: RR POSITION RANGE (less than 2.5V)	Min/Max should be over 2.5V for best performance. Level Sensor swing is less than 2.5V from Min to Max. Though the suspension will work, 2.5V or more is optimal.	

SOLENOID VALVE RELATED ERRORS

ERROR CODES AND TEXT	POSSIBLE ISSUE	SOLUTIONS
ERROR 101: LF SOLENOID INFLATE NOT CONNECTED ERROR 111: RF SOLENOID INFLATE NOT CONNECTED ERROR 121: LR SOLENOID INFLATE NOT CONNECTED ERROR 131: RR SOLENOID INFLATE NOT CONNECTED	Check harness between ECU and valves. CHECK THE GROUND AT THE VALVES.	Is the valve harness plugged into the ECU? Is the valve harness plugged into the valves? Is the vehicle charging system operating correctly?
ERROR 102: LF SOLENOID DEFLATE NOT CONNECTED ERROR 112: RF SOLENOID DEFLATE NOT CONNECTED ERROR 122: LR SOLENOID DEFLATE NOT CONNECTED ERROR 132: RR SOLENOID DEFLATE NOT CONNECTED		Is the valve connected to chassis ground?

RIDEPRO^{e5} Control System Error Codes

COMPRESSOR & SYSTEM RELATED ERRORS

ERROR CODE & TEXT	POSSIBLE ISSUE	SOLUTIONS
ERROR 141: COMPRESSOR #1 NOT CONNECTED ERROR 151: COMPRESSOR #2 NOT CONNECTED	Check wiring and fuse. Compressor overheated and thermaled out. The compressor has a thermal switch that will turn the compressor off if it gets too hot. This is to protect the compressor. It will come back on after it cools.	Is the valve compressor plugged into the ECU? Is the harness plugged into the compressor? Is the compressor connected directly to the battery? Is the compressor fuse blown?
ERROR 142: COMPRESSOR #1 OVER CURRENT ERROR 152: COMPRESSOR #2 OVER CURRENT	Compressor may have failed or improper wiring.	Is the vehicle charging system operating properly? Is the compressor hot? If so, let cool.
ERROR 143: COMPRESSOR #1 NO FILL ERROR 153: COMPRESSOR #2 NO FILL	Compressor has been installed improperly, or has failed.	Is the compressor connected to the tank? Are there any open ports or airlines in the system?
ERROR 144: COMPRESSOR #1 DUTY CYCLE ERROR 154: COMPRESSOR #2 DUTY CYCLE	Duty cycle has been exceeded. Please wait for the compressor to cool. Compressor will turn on automatically after it cools.	
ERROR 145: COMPRESSOR #1 WORN OUT ERROR 155: COMPRESSOR #2 WORN OUT	Compressor replacement may be required.	Is there a major leak in the air supply system? If no leaks, compressor replacement may be required.
ERROR 146: COMPRESSOR #1 SHORTED ERROR 156: COMPRESSOR #2 SHORTED	Wire harness damaged or compressor has failed. Compressor amp draw is too high for control system.	Is the valve compressor plugged into the ECU? Is the harness plugged into the compressor? Is the compressor connected directly to the battery? Is the compressor fuse blown?
ERROR 161: VEHICLE VOLTAGE LOW	Compressors have been disabled. Compressors will come back on after the vehicle's voltage increases to 12.8V.	Vehicle voltage has dropped below 10v. Is the vehicle's engine running? Is the vehicle's charging system operating correctly?
ERROR 162: VEHICLE VOLTAGE HIGH	Vehicle voltage has exceeded 18V.	Is the vehicle's engine running? Is the vehicle's charging system operating correctly? Is the vehicle on a battery charger?
ERROR 163: COMMUNICATION	Is the display harness plugged into the ECU? Is the display harness pinched or shorted??	
ERROR 164: CALIBRATION FAIL!	Calibration failed due to errors during calibration. Fix errors that popped up on the screen and rerun calibration.	
ERROR 165: WRONG VERSION	Software Version of the ECU/WCU do not match the laptop software. You will need matching software to run the system with a laptop. You may need to install new software on the ECU/WCU or the laptop, depending on the version that is installed of each item. Contact Ridetech @ 812-481-4969 to determine which needs updated.	
ERROR 166: HARDWARE FAILURE	Internal Hardware Failure in ECU or WCU.	Contact Ridetech @ 812-481-4969 to resolve issue.
ERROR 167: CALIBRATION FAILURE	Calibration too many steps to complete. Check system for air leaks. Check for suspension bind. It may require the suspension pivot bolts to be loosened for calibration. Retighten after rerunning calibration. Contact Ridetech @ 812-812-481-4969 if the system will not go through calibration.	
ERROR 168: CAN NOT EXECUTE MOVE TO PRESET	Errors occurred while trying to #1, #2 or #3 preset.	Fix errors that occurred while the system was attempting a move to preset.
ERROR 169: SOLENOID OVER CURRENT	Check harness between ECU and valves Check valve ground.	Is the valve harness plugged into the ECU? Is the valve harness plugged into the valves? Do the valves have a good ground?
ERROR 171 & 172: MOVE TO PRESET TIME-OUT!	Move has exceeded the maximum allowable time or steps.	Did the vehicle reach the desired preset? Is there adequate air in the supply tank? Is the supply tank of adequate size for the application?
ERROR 181: POSITION SENSORS INCORRECT SWING	Sensors moving out of range or incorrect corner is moving	Use the Diagnostics tab on the App to check the level sensor voltages.

RIDEPRO^{e5} Plumbing Diagram

Single Compressor Systems

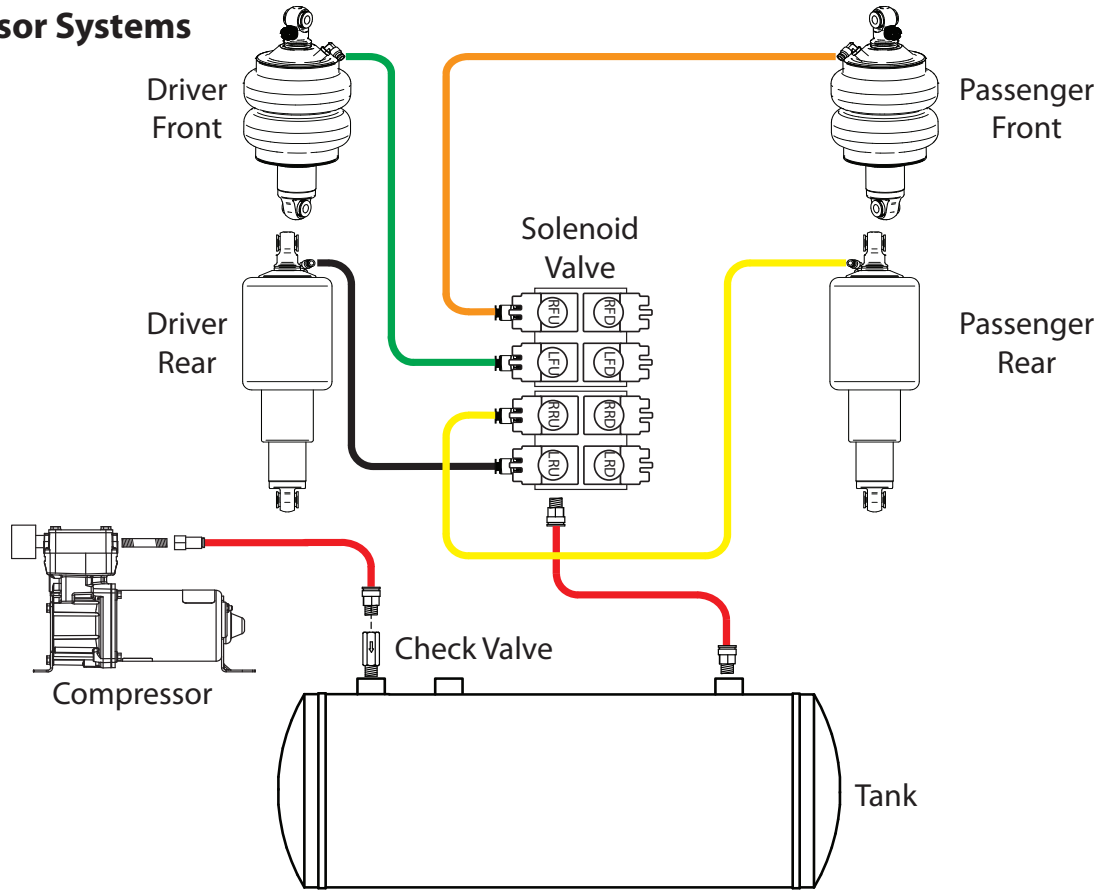

Dual Compressor Systems

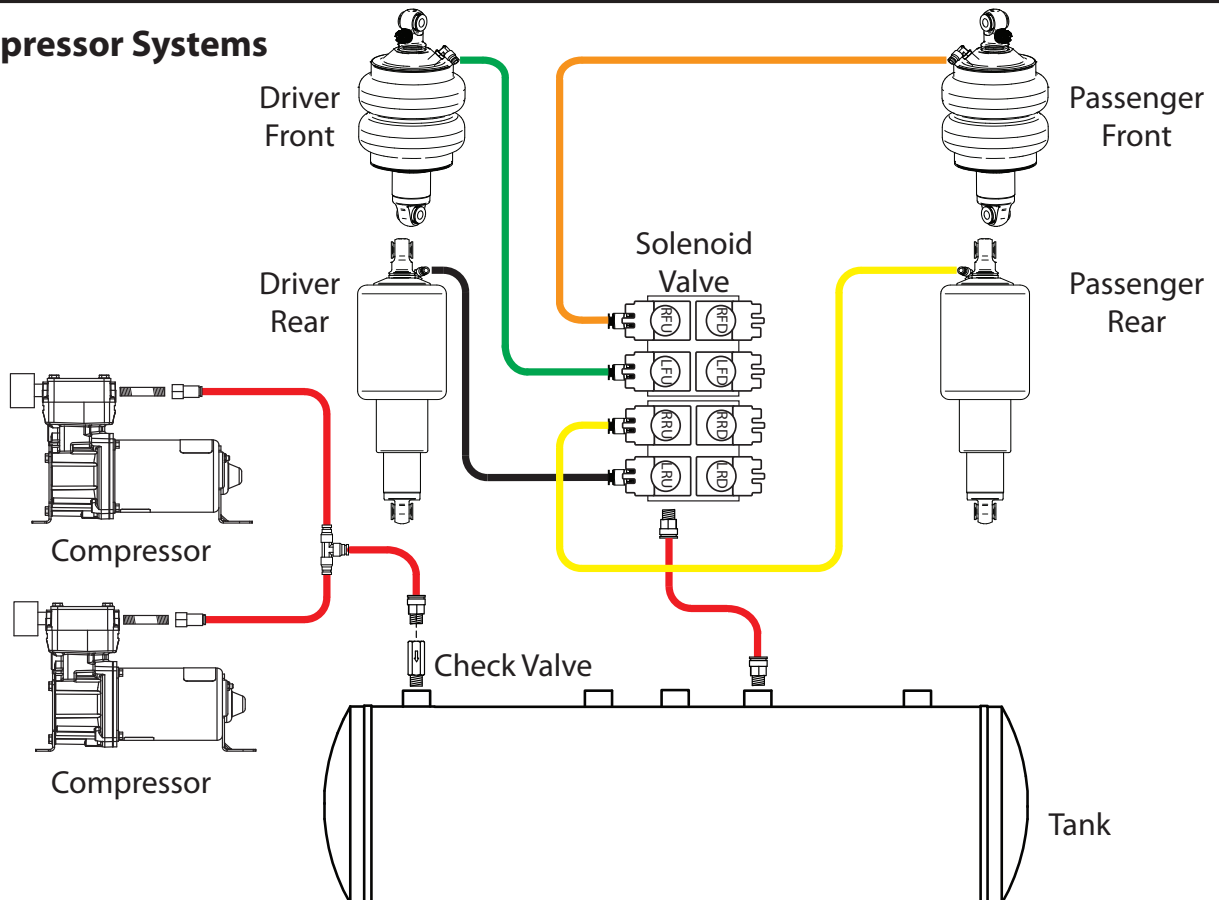

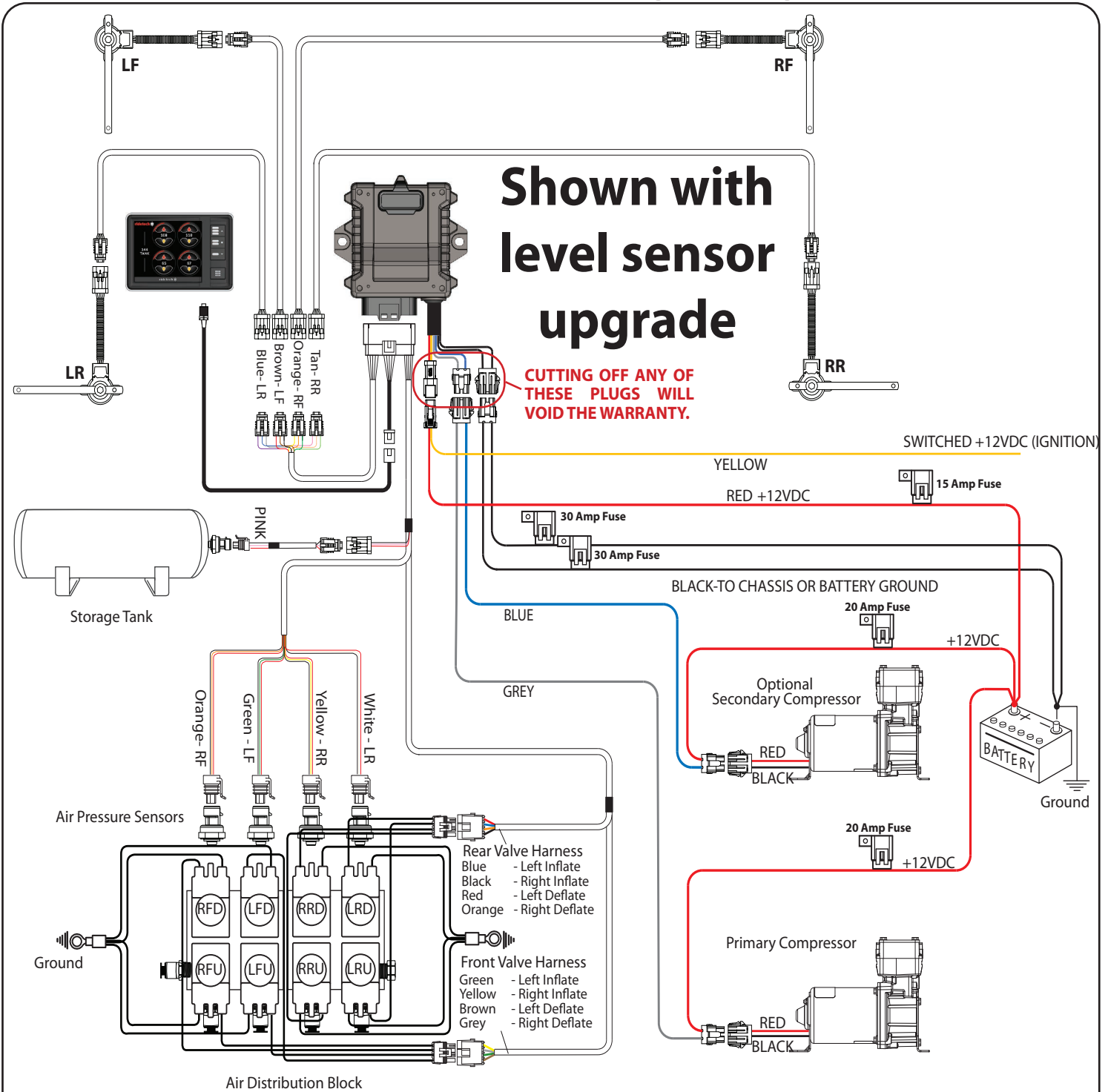

NOTE: AIRPOD WIRING IS THE SAME, BUT THE AIRPOD HAS IT'S OWN FUSE BLOCK FOR THE ECU AND COMPRESSOR(S). THE AIRPOD STILL REQUIRES A FUSE TO BE INSTALLED AT THE BATTERY. See page 7.



350 S. St. Charles St. • Jasper, IN 47546 • 812-481-4969