



DON'T FORGET

These instructions can be found in color and expandable at QA1.net

Technical Support Line: (952) 985-5675 Email: sales@QA1.net

INSTALLATION INSTRUCTIONS

QA1 P/N 52700 Lower Control Arms
'65-'70 Chevrolet Impala, Caprice, Belair, Biscayne

TOOLS AND SUPPLIES REQUIRED

- Floor Jack
- Jack Stands
- Wrench Set
- Ratchet & Socket Set
- Spring Compressor
- Ball Joint Separator
- Internal & External snap ring pliers
- Razor blade or box cutter knife

PRE INSTALLATION NOTES:

These control arms require the use of coil-overs and will not work with factory style coil springs.

The factory front sway bar will not work with these control arms. QA1 part number 52848 is the correct front sway bar.

QA1 front coil-overs come with poly bushings and T-bars installed in the lower shock connection for customers using them on factory control arms. QA1 control arms require the installation of the included spherical bearing mounts. Refer to page 4 for installation instructions.

QA1 does not recommend driving the vehicle until it has been properly aligned. *A front-end alignment should be performed by a qualified alignment shop after any changes to the suspension system.*

Disassembly With Factory Type Springs

1. Raise and support the vehicle by the frame with jack stands on a stable surface and remove the front wheels.
2. Remove the brake calipers and hang them up out of the way. Do not let the calipers hang by the brake hose.
3. Remove the sway bar end links. (if equipped)
4. Unbolt the upper shock mounts from the inside the engine bay.
5. Unbolt the lower shock mount and remove the shock.
6. Remove the nut and front bushing from the strut rod.
7. Remove the two nuts holding the strut rod to the lower control arm followed by the front connection and remove the strut rod from the vehicle. **(Figure 1)**
8. Remove the cotter pin and loosen the lower ball joint castle nut.

Do not remove the nut at this time.

9. With the castle nut still threaded onto the stud, separate the lower ball joint from the spindle using a ball joint separator.
10. Support the lower control arm with a jack to take pressure off the droop stop and to contain the spring pressure. **(Figure 2)**
11. Remove the lower ball joint nut.
12. Slowly lower the jack supporting the lower control arm to release any remaining spring pressure. A spring compressor may need to be used to safely release all pressure.
13. Remove the spring.



Figure 2



Figure 1

14. With the coil spring removed, remove the upper ball joint castle nut and remove the spindle.
15. Mark the position of the eccentric on the eccentric and the frame at the control arm pivot point. **(Figure 3)** Remove the lower control arm pivot bolt, then the arm.



Figure 3

Disassembly With Front Coil-overs

1. Raise and support the vehicle by the frame with jack stands on a stable surface and remove the front wheels.
2. Remove the brake calipers and hang them up out of the way. Do not let the calipers hang by the brake hose.
3. Remove the sway bar end links. (if equipped)
4. Remove the nut and front bushing from the strut rod.
5. Remove the two nuts holding the strut rod to the lower control arm and remove the strut rod.
6. Remove the cotter pin in the lower ball joint stud and loosen the castle nut.
Do not remove the nuts at this time.
7. With the castle nut still threaded onto the stud, separate the lower ball joint from the spindle using a ball joint separator.
8. Lower the spring seat collar to the bottom of the coil-over shock to release any spring pressure.
9. Support the lower control arm with a jack to take pressure off the droop stop and to contain and remaining spring pressure. **(Figure 2)**
10. Unbolt the upper shock mount from inside the engine bay.
11. Slowly lower the jack supporting the lower control arm to release any remaining spring pressure. A spring compressor may need to be used to safely remove the pressure.
12. Unbolt the lower shock mount and remove the shock and spring.
13. Remove the lower ball joint castle nut and remove the ball joint stud from the spindle.
14. Remove the upper ball joint castle nut and remove the spindle.
16. Mark the position of the eccentric on the eccentric and the frame at the control arm pivot point. **(Figure 3)** Remove the lower control arm pivot bolt, then the arm.



Figure 4

INSTALLATION-

NOTE: Part number references can be matched to the exploded diagram on page 7.

1. Clean the frame surface of the chassis where the strut rod previously passed through. **(Figure 4)**
2. Insert the included sleeves (#3.4) into the pivot bushings of the control arms. **(Figure 5)**
3. Using red loctite, thread the 7" stud (#3.6) into the front of the control arm with two (#3.7.7) jam nuts. Leave 5.5" of threads sticking out of the arm and tighten the first jam nut into the control arm to lock the stud in place. **(Figure 6)**
4. Install one washer (#3.1) onto the threaded rod with followed by one bushing (#3.3.2) **(Figure 7)**



Figure 5



Figure 7

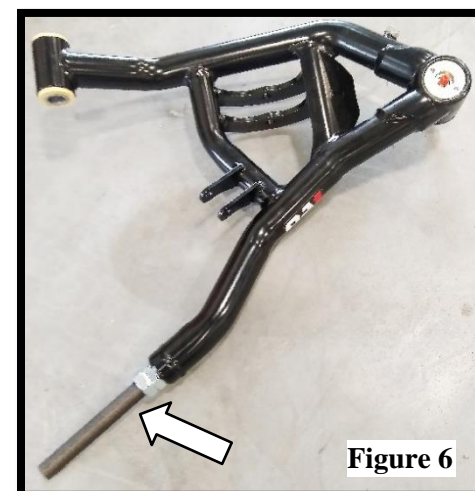

Figure 6

5. With one cupped washer (#3.2) on each side of the rear bushing connection, install the arm into the rear mount with the front stud positioned through the factory strut rod hole. **(Figure 8)**

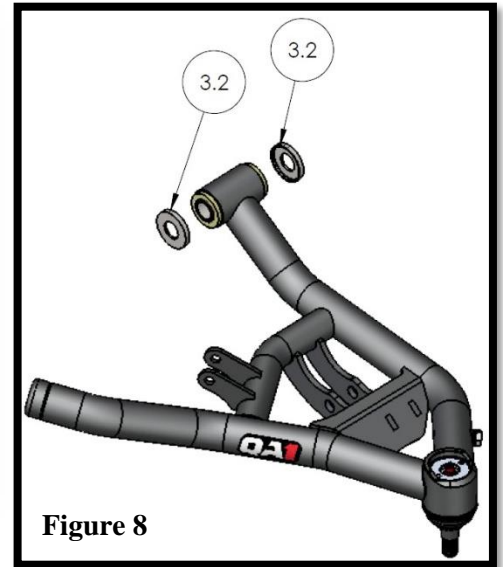
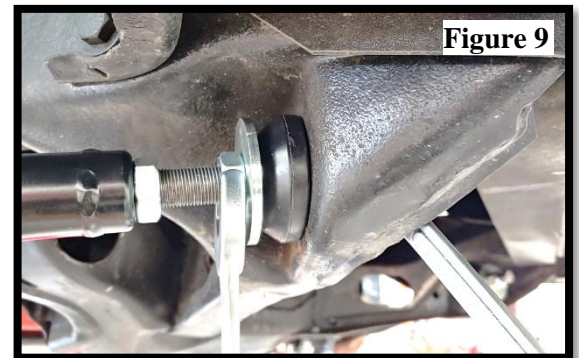
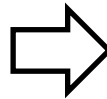
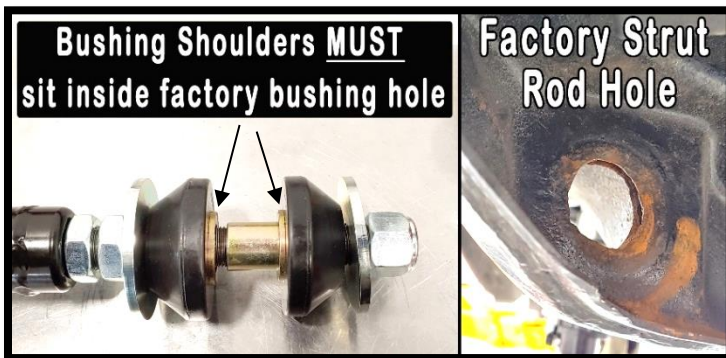

Figure 8

6. Adjust the arm so that the shoulder of the front bushing is seated into the factory strut rod hole. **(Figure 9)**
7. Install the additional shouldered bushing (#3.3.2), washer (#3.1), and nylock nut (#3.6.6) onto the threaded rod on the front side of the factory strut rod hole.



8. Reinstall the rear mounting bolt with the factory eccentric lined up with your original mark. **(Figure 2)** Do not torque the rear connection down until making the front adjustment in the next step.
9. Adjust the front connection of the control arm so that there is 1/2" of threads (eight threads) between the jam nut at the arm and the adjustment nut of the rear bushing. This is a starting point for approximately 3-4 degrees of caster. **(Figure 10)** During this adjustment the bushing shoulders MUST stay seated in the factory strut rod hole. To do this, make small adjustments to both nuts to keep pressure on the bushings. **(Figure 9)**

1/2" of threads showing between nuts.



10. Torque the front bushing connection and rear pivot bolt connection to 97 lb. ft. once the vehicle is sitting at ride height or with the arm supported to simulate approximate ride height.

INSTALLATION NOTE:

QA1 Coil-over shocks come with poly bushings and t-bars installed in the lower shock connection for customers who are using them on (most other) GM factory control arms. QA1 control arms require the lower shock bushing to be swapped out with the included spherical bearing mount.

11. Install the provided spherical bearing kit (#3.8.1, #3.8.2, #3.8.2) into the lower shock mount using the following steps:



12. Connect the lower shock mount to the control arm using 1/2" x 2.5" mounting bolt (#3.6.1), two washers (#3.6.2) and nylock nut (#3.6.3). Torque to 50 lb. ft.

13. Remove the factory bump stop from the chassis. **(Figure 11)**

14. Mark and drill a new bump stop hole 3/4" forward of the original factory hole with a 3/8" drill bit.

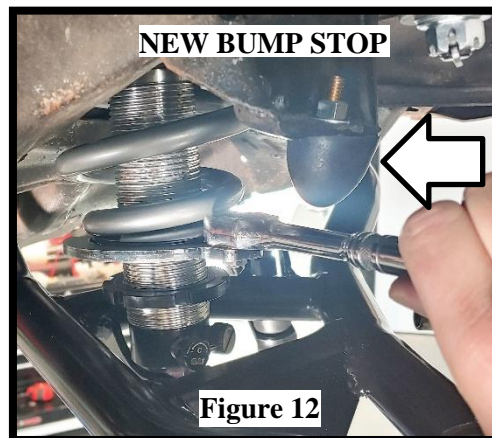
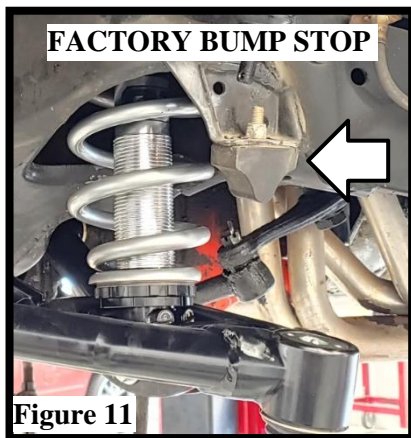

15. Install the included bump stop (#3.5) using one washer (#3.6.8) and nut (#3.6.9) **(Figure 12)** Torque to 31 lb. ft.

16. Connect the lower ball joint into the spindle. Torque to 65 lb. ft. Continue tightening to line up the cotter pin hole. Never loosen the ball joint to find the cotter pin hole.

17. Connect the upper ball joint to the spindle. Torque to 50 lb. ft.

18. Reinstall the brake calipers.
19. If using the QA1 front sway bar (p/n 52848), refer to the installation instructions included with the sway bar to install.
20. Double check all work before re-installing the wheels.

A PROFESSIONAL ALIGNMENT SHOULD BE PERFORMED BEFORE DRIVING THE VEHICLE

Alignment Information

QA1 upper and lower control arms are designed to add more caster and negative camber. It is a good idea to make the alignment shop aware of this, as the alignment shop will only try to align the vehicle to factory specs. These alignment specifications are for vehicles equipped with both QA1 upper and lower control arms. The majority of the alignment adjustments for the 65-70 GM Full size is done at the lower control arms. Shims can also be added to the upper control arms to adjust caster & camber. Vehicles using these upper control arms with factory lower arms may not be able to achieve the QA1 listed alignment specifications.

Stock Alignment Specs:

Camber: .8° to -.3°
 Caster: .3° to 1.3°
 Cross Caster: ± .5°
 Toe: .1° to .6° toe in

QA1 Alignment Specs:

Camber: 0° to -1°
 Caster: 3° to 5°
 Cross Caster: ± .5°
 Toe: .1° to .3° toe in

NOTE ON ALIGNMENT SPECS:

Alignment specifications will vary based on the vehicles use and the above are based on street vehicles. Autocross and track prepped cars will typically use up to 2 degrees of negative camber, max out the available caster, and use 1/8" toe-out alignment spec. Drag racing will typically use similar specs to a street car while maxing out the positive caster with varying toe-in settings to increase straight line stability. Consult with your alignment professional for the specifications that will work best for your application.



Technical Support Line: (952) 985-5675 Email: sales@QA1.net

READ ALL INSTRUCTIONS CAREFULLY AND THOROUGHLY PRIOR TO STARTING INSTALLATION. PRODUCTS THAT HAVE BEEN INSTALLED ARE NOT ELIGIBLE FOR RETURN. USE THE PROPER JACKING LOCATIONS. DEATH OR SERIOUS INJURY CAN RESULT IF INSTRUCTIONS ARE NOT CORRECTLY FOLLOWED. A GOOD CHASSIS MANUAL, AVAILABLE AT YOUR LOCAL PARTS STORE, MAY ALSO AID IN YOUR INSTALLATION.

• DISCLAIMER / WARRANTY •

QA1 WARRANTS THAT THE PRODUCTS WILL BE FREE FROM DEFECTS IN MATERIAL AND WORKMANSHIP FOR ONE YEAR FROM DATE OF SALE TO THE ORIGINAL PURCHASER. QA1 MAKES NO OTHER WARRANTY OF ANY KIND, EXPRESS OR IMPLIED. QA1 SHALL HAVE NO OBLIGATION UNDER THE FOREGOING WARRANTY WHERE THE DEFECT IS THE RESULT OF IMPROPER OR ABNORMAL USE, YOUR NEGLIGENCE, VEHICLE ACCIDENT, IMPROPER OR INCORRECT INSTALLATION OR MAINTENANCE, NOR WHEN THE PRODUCT HAS BEEN REPAIRED OR ALTERED IN ANY WAY. QA1'S LIABILITY IN THE CASE OF DEFECTIVE PRODUCTS SUBJECT TO THE FOREGOING WARRANTY SHALL BE LIMITED TO THE REPAIR OR REPLACEMENT, AT QA1'S OPTION, OF THE DEFECTIVE PRODUCTS.

THE USER UNDERSTANDS AND RECOGNIZES THAT RACING PARTS, SPECIALIZED STREET ROD EQUIPMENT, AND ALL PARTS AND SERVICES SOLD BY QA1 ARE EXPOSED TO MANY AND VARIED CONDITIONS DUE TO THE MANNER IN WHICH THEY ARE INSTALLED AND USED. QA1 SHALL BEAR NO LIABILITY FOR ANY LOSS, DAMAGE OR INJURY, EITHER TO A PERSON OR TO PROPERTY, RESULTING FROM THE INSTALLATION, DIRECT OR INDIRECT USE OF ANY QA1 PRODUCTS OR INABILITY BY THE BUYER TO DETERMINE PROPER USE OR APPLICATION OF QA1 PRODUCTS. WITH THE EXCEPTION OF THE LIMITED LIABILITY WARRANTY SET FORTH ABOVE, QA1 SHALL NOT BE LIABLE FOR ANY CLAIMS, DEMANDS, INJURIES, DAMAGES, ACTIONS, OR CAUSES OF ACTION WHATSOEVER TO BUYER ARISING OUT OF OR CONNECTED WITH THE USE OF ANY QA1 PRODUCTS. MOTORSPORTS ARE DANGEROUS; AS SUCH, NO WARRANTY OR REPRESENTATION IS MADE AS TO THE PRODUCT'S ABILITY TO PROTECT THE USER FROM INJURY OR DEATH. THE USER ASSUMES THAT RISK!

Dedicated Technical Support Team

QA1 is dedicated to providing quality support and instructions. We employ passionate racers and car enthusiasts that know our products and the industry to better serve you.

Give our tech support line a call at **1.800.721.7761**

Visit online at www.QA1.net/tech or www.YouTube.com/QA1Tech for:

- Frequently Asked Questions
- Quick Tips
- Install Information
- Tuning and Repair Guides
- Other Technical Information

Our technical support and order lines are open **Monday – Friday, 8 am to 5 pm CST.**



BALLOON #	ITEM #	DESCRIPTION	QTY.
1	9637-421	ASSEMBLY, LCA, LH	1
2	9637-430	ASSEMBLY, LCA, RH	1
3	7039-282	INSTALL KIT, LOWER CONTROL ARM	1
3.1	9637-454	WASHER, LCA, FRONT PIVOT	4
3.2	9637-455	WASHER, LCA, REAR BUSHING	4
3.3	9032-420	STRUT ROD BUSHING, POLY	1
3.3.1	-	STRUT ROD SLEEVE	2
3.3.2	-	STRUT ROD BUSHING	4
3.4	9033-490	SLEEVE, 1.000", .766", 2.694"	2
3.5	9047-113	BUMP STOP, BULLET 1.5" OD X 1.56" TALL	2
3.6	7039-279	HARDWARE KIT, LOWER CONTROL ARM	2
3.6.1	-	BOLT, 1/2-20 RH, 2.5"	1
3.6.2	-	WASHER, FLAT 1/2" AN960-816 CZ	2
3.6.3	-	NUT, NYLOCK, 1/2-20	1
3.6.4	-	PIN, COTTER 7/64" X 1-1/4"	1
3.6.5	-	NUT, NYLOCK, 3/4-16	1
3.6.6	-	NUT, NYLOCK, 3/4-16	1
3.6.7	-	JAM NUT, 3/4-16 RH	2
3.6.8	-	WASHER, SAE, 3/8"	1
3.6.9	-	NUT, 3/8-16	1
3.7	9637-453	STUD, 3/4-16, 7.0"	2
3.8	COM8T-102PK	KIT BEARING (COM) .500" X 1.0" WIDETEF.	1
3.8.1	COM8T-102	BEARING (COM) 52100 HT CP/	2
3.8.2	9007-117	Retaining Ring, Int. 1"	4

