



## P/N 96037 LS Valve Cover Conversion Kit-BBC Valve Covers

Works with;

- LS Cylinder Heads
- AC Delco D514A Coils (GM P/N 12573190) Round or AC Delco 510C (GM P/N 12611424) Flat Coils (coils not included)
- OEM LS Valve Cover Gaskets P/N 12637683 (not included)
- Big Block Chevrolet valve covers and gaskets (not included)

- 1) Remove existing valve covers, inspect gaskets and replace if necessary with GM P/N 12637683 or similar gasket.
- 2) Install spacer nuts into cylinder head and torque to 45 Inch-pounds. **DO NOT OVER TIGHTEN!**
- 3) Insert the OEM LS valve cover gasket into the gasket channel of the conversion base. Make sure the gasket is seated properly and head surface is clean.
- 4) Each conversion base is marked Driver or Passenger side. Select one and install the four 1/4-20 x 3/4" socket head cap screws with washers through the conversion base and into the pre-installed spacer nuts, torque to 8 ft lbs. Repeat for other side. Install oil fill caps at this time, one on each side.

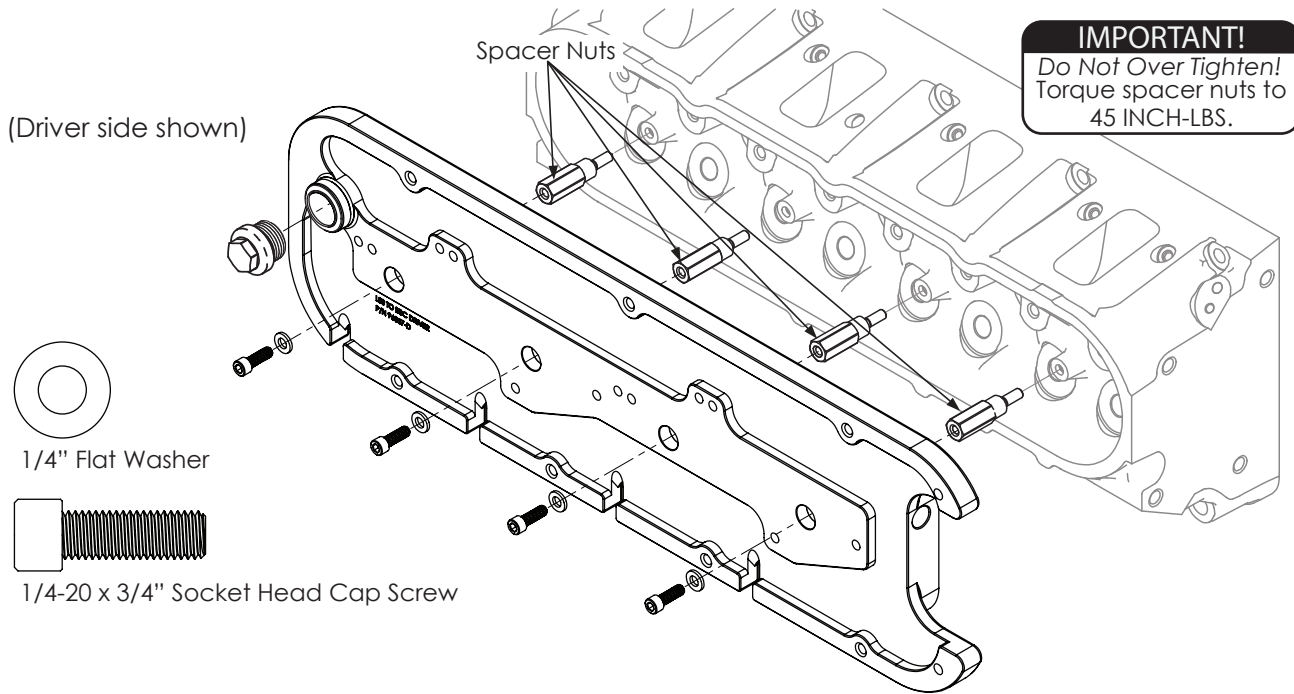

- 5) Locate the mounting holes you will be using with the diagram below.

### Coil Mounting Position

R = Round Coil

F = Flat Coil

F&R = Both Coils

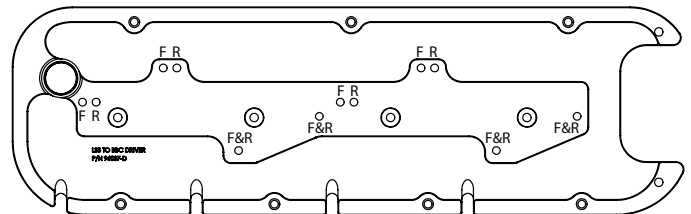
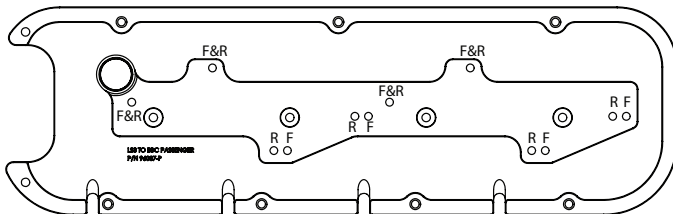

**This kit requires the following coils;**

AC Delco D514A Coils (GM P/N 12573190) Round or AC Delco 510C (GM P/N 12611424) Flat Coils

6) Mount your coils as shown, notice coil position and spacers needed for each application.

### Flat Coil - AC Delco 510C / GM P/N 12611424

Use all short spacers

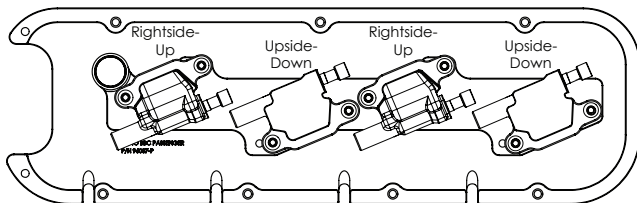

Passenger Side P/N 96037-P

Use all short spacers

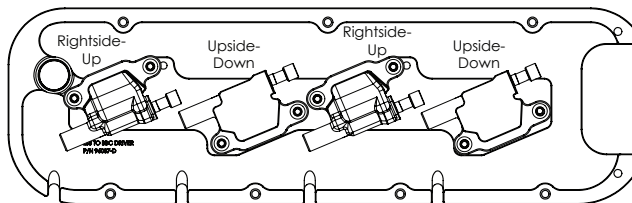

Driver Side P/N 96037-D

### Round Coil - AC Delco 514A / GM P/N 12573190

Long Spacers    Short Spacers    Long Spacers    Short Spacers

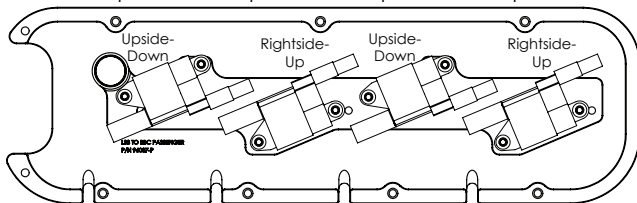

Passenger Side P/N 96037-P

Long Spacers    Short Spacers    Long Spacers    Short Spacers

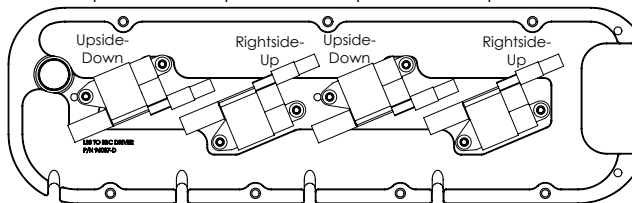

Driver Side P/N 96037-D

### Coil Mounting Hardware



Long Spacer  
.800" Long

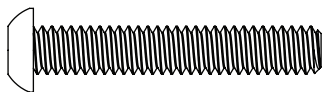

1/4-20 x 1-1/2" Button Head

Used for; Upside-Down Round Coils

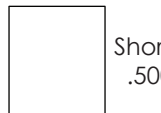

Short Spacer  
.500" Long

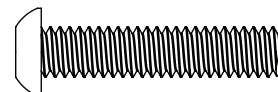

1/4-20 x 1-1/4" Button Head

Used for; Flat Coils & Rightside-up Round Coils

7) Ignition coil harness and Ignition wire installation:

**Requires aftermarket Ignition wire set that is longer than stock. Taylor 92046, Accel P/N9060C, MSD 32073/32079 or similar.**

- Make note and label coil plugs for position, remove plastic coil wire harness cover. Route the coil harness through and around coils for best position. The main plug can rest under the valve cover or exit out the back.
- Install the ignition wires per manufacturer's instructions.
- Check firing order and test run vehicle.



Flat Coil - AC Delco 510C / GM P/N 12611424

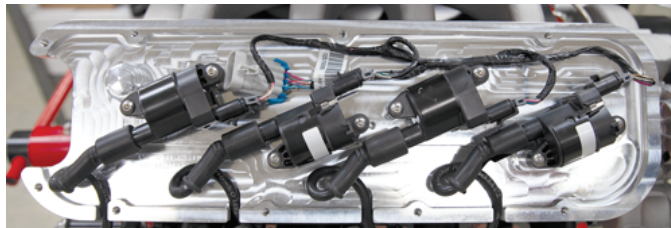

Round Coil - AC Delco 514A / GM P/N 12573190

8) Finish by installing your Big Block Chevrolet valve covers and gaskets.

