

banks

Owner's Manual with Installation Instructions

Banks Ram-Air® Intake System

**2003-2007 Ford Power Stroke 6.0L
Turbo-Diesel F250/F350/F450 Trucks**

THIS MANUAL IS FOR USE WITH SYSTEM 42155

Gale Banks Engineering
546 Duggan Avenue • Azusa, CA 91702
(626) 969-9600 • Fax (626) 334-1743

Product Information & Sales: (888) 635-4565

bankspower.com

BANKS

Also Available from Banks Power

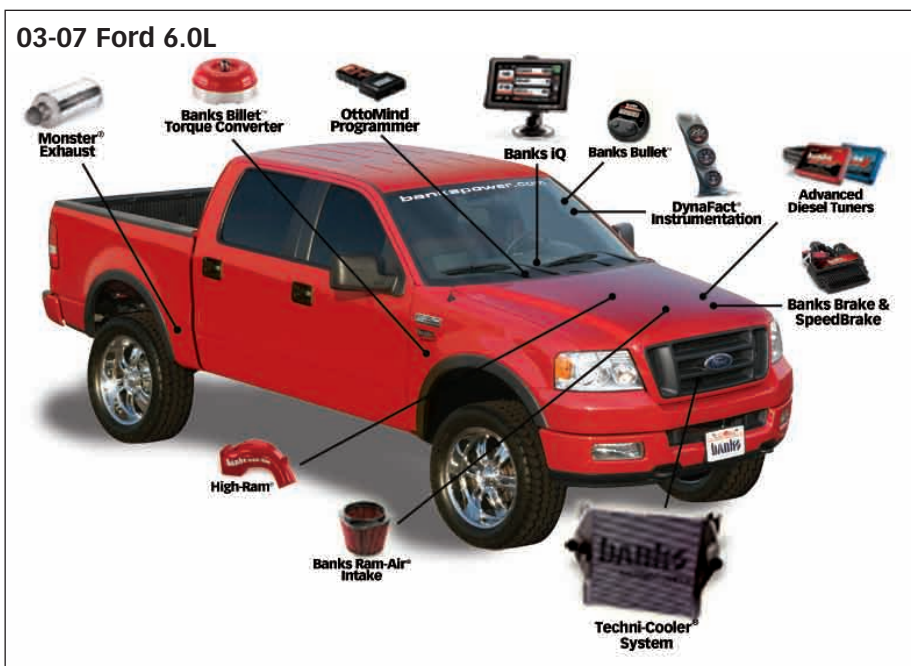

Banks IQ System (P/N 61151-61152)

- 5" touchscreen interface that can control the Banks Diesel Tuner and/or SpeedBrake on the fly.
- Interchangeable gauge display, read and clear codes, monitor engine diagnostics, log data, time your vehicles runs and much more.

Banks Monster® Exhaust System Sport (P/N 48790-48793) **Single and Dual** (P/N 47285-47292, 47606-47609, 48783-48788)

- Increases exhaust flow, cuts backpressure, lowers exhaust gas temperatures (EGTs) and increases power.

High-Ram Intake (P/N 42750-42751)

- Increases flow and provides more uniform air distribution to the engine for more available power at a given boost level.

Banks Techni-Cooler® System (P/N 25974-25975)

- Provides increased air flow to the engine by increasing air density for more increased power, lower EGTs and improved fuel economy.

Banks Brake (P/N 55467-55468)

- Increases the stopping power of your truck and extends the service life of your brakes

**Banks Billet Torque Converter
(P/N 72522)**

- Higher torque capacity over stock
- Lockup clutch is slip-resistant so transmission fluids stay cooler and transmission life is prolonged.

**Banks SpeedBrake
iQ Compatible (P/N 55455-55456)
PDA Compatible (P/N 55457-55458)**

- Allows for controlled hill decent at a user defined vehicle speed.

**Boost and Pyro Gauges
(P/N 64507)**

- Keep your engine safe by monitoring vital engine parameters

**Banks Bullet
(P/N 66524-66525)**

- Adds power safely to your vehicle
- Displays critical engine functions
- Engine safeguards
- Change power levels on-the-fly

**Banks Diesel Tuner
Six-Gun w/ switch (P/N 61023)
Six-Gun w/ iQ (P/N 63749)
EconoMind w/ switch (P/N 63743-63745)
EconoMind w/ iQ (P/N 63747-63748)**

- Adds power safely to your vehicle
- Engine and transmission safeguards
- Change power levels on-the-fly

**Banks Speed-Loader
(P/N 62988)**

- Furthers the power output of the Banks Six-Gun and provides EGT limiting safety.

Thermocouple

- Add a temperature limiting function to your Diesel Tuner

**OttoMind Programmer
(P/N 66064)**

- Contains Banks tunes that boost your vehicles HP, Torque and MPG.
- Displays a host of critical engine functions
- Provides "service technician" diagnostic capabilities
- Has upgradeable functionality, so it will never be out of date

**Banks Stinger Systems
(P/N 46465-46486)**

Contains:

- Ram-Air Intake system
- Monster Exhaust (single or dual)
- EconoMind Tuner w/ Banks iQ

**Banks PowerPack Systems
(P/N 46497-46519)**

Contains:

- Ram-Air Intake system
- Monster Exhaust (single or dual)
- EconoMind Tuner w/ Banks iQ
- High-Ram
- Techni-Cooler System

**Banks Six-Gun Bundle
(P/N 46594-46613)**

Contains:

- Ram-Air Intake system
- Monster Exhaust (single or dual)
- Six-Gun Tuner w/ Banks iQ

**Banks Big Hoss Bundle
(P/N 46623-46643)**

Contains:

- Ram-Air Intake system
- Monster Exhaust (single or dual)
- Six-Gun Tuner w/ Banks iQ
- Big Head Wastegate Actuator
- High-Ram
- Techni-Cooler System

**For More Information please call (800) 438-7693
or Visit us online @ www.bankspower.com**

General Installation Practices

Dear Customer,

If you have any questions concerning the installation of your Banks Ram-Air System, please call our Technical Service Hotline at (888) 839-2700 between 7:00 am and 5:00 pm (PT). If you have any questions relating to shipping or billing, please contact our Customer Service Department at (888) 839-5600.

Thank you.

1. For ease of installation of your Banks Ram-air intake system, familiarize yourself with the procedure by reading the entire manual before starting work. This manual contains 16 pages of copy, illustrations and parts listing. If any pages are missing from this manual please call Gale Banks Engineering immediately for a replacement.
2. The exploded view of the Ram-Air assembly (pages 4-5) provides only general guidance. Refer to each step and section diagram in this manual for proper instruction.
3. Throughout this manual, the left side of the vehicle refers to the driver's side, and the right-side to the passenger's side.
4. Disconnect the ground cable from the battery before beginning work. If there are two batteries, disconnect both.

5. Route and tie wires and hoses a minimum of 6 inches away from exhaust heat, moving parts and sharp edges. Clearance of 8 inches or more is recommended where possible.

6. During installation, keep the work area clean. If foreign debris is transferred to any Banks system component, clean it thoroughly before installing.

7. When raising the vehicle, support it on properly weight-rated safety stands, ramps or a commercial hoist. Follow the manufacturer's safety precautions. Take care to balance the vehicle to prevent it from slipping or falling. When using ramps, be sure the front wheels are centered squarely on the topsides; put the transmission in park; set the parking brake; and place blocks behind the rear wheels.

Caution! Do not use floor jacks to support the vehicle while working under it. Do not raise the vehicle onto concrete blocks, masonry or any other item not intended specifically for this use.

Notification

The Banks Ram-Air Filter comes pre-oiled and no oiling is necessary for the initial installation. Service the filter as specified in the Filter Maintenance Section of this manual.

Tools Required:

- 3/8" drive ratchets with metric and standard sockets
- Standard and Phillips head screwdrivers
- Standard and needle-nose pliers
- Clean shop towels or rags
- 5/16 nut driver

Table of Contents

Section 1	6
General Assembly	
Section 2	8
Ram-Air Installation	
Section 3	17
Filter Maintenance	

Section 1

GENERAL ASSEMBLY

Figure 1

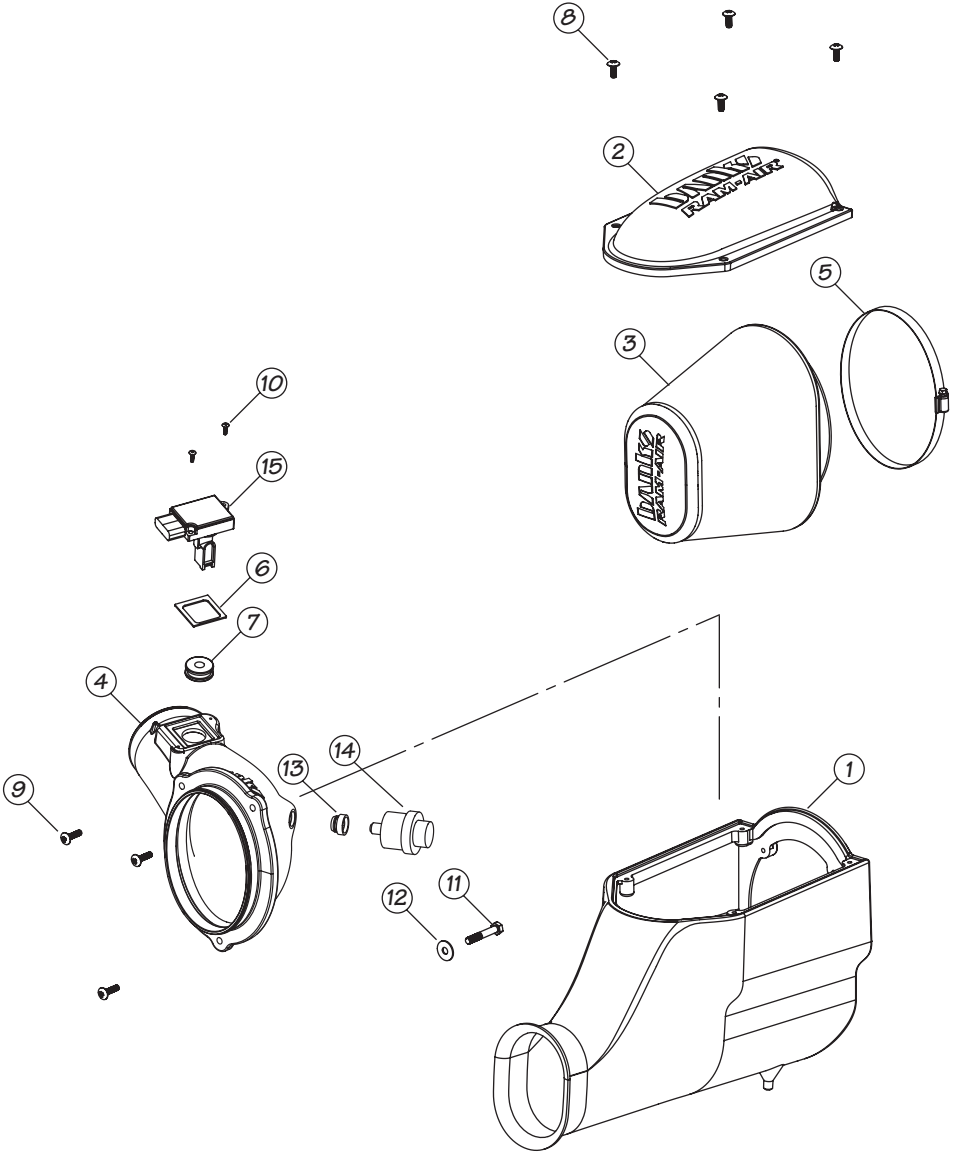

Item #	Part #	Description	Qty
1	42156	HOUSING, RAM-AIR FILTER	1
2	42165	COVER, RAM-AIR HOUSING	1
3	42158	AIR FILTER ELEMENT, RAM-AIR SYSTEM	1
4	42159	INTAKE TUBE, RAM-AIR SYSTEM	1
5	92904	HOSE CLAMP, #104	1
6	93070	GASKET, MAF SENSOR	1
7	93628	GROMMET, INTAKE AIR TEMPERATURE SENSOR	1
8	91133	SCREW, TRUSS HEAD, PHILLIPS, 1/4-20 X .75	4
9	91136	SCREW, TRUSS HEAD, PHILLIPS 1/4-20 X 1	3
10	91719	SCREW, TRUSS HEAD, PHILLIPS, 6-32 X 1/2	2
11	91794	SCREW, HEX HEAD, M8 X 1.25 X 50	1
12	91702	WASHER, LARGE, M8	1
13	*	STOCK GROMMET, FILTER MINDER	*
14	*	STOCK FILTER MINDER	*
15	*	STOCK MAF SENSOR	*
16	*	STOCK INTAKE AIR TEMPERATURE SENSOR	*

* These are stock components that will be reused with the Banks Ram-Air System.

Section 2

RAM-AIR INSTALLATION

Use the Bill of Materials Chart and the General Assembly Drawing to reference component nomenclature and location. Use caution when working in the engine compartment. Make sure the engine has been OFF for several hours and cool.

You are about to install the Banks Ram-Air Intake System. Read and follow all steps before working on the vehicle. Some components from the stock air intake system will remain in service. Take care when removing stock air intake components to not damage them.

1. Remove the auxiliary air inlet hose located on the front of the factory air filter cover. Use pliers to remove the auxiliary air inlet hose clamp and set aside. See **Figure 2**.

2. Unfasten the four tension clamps located on the top of the factory air box.

3. Loosen the hose clamp on the air inlet bellows located next to the Mass Air Flow (MAF) sensor. See **Figure 3**.

Note: Some vehicles do not have a MAF sensor but instead utilize an Intake Air Temperature (IAT) sensor. Both sensor types are installed in the same location on the intake tube.

4. Locate the MAF/IAT connector, press the release tab and carefully remove the MAF/IAT connector and set aside.

5. Remove the Air Filter Minder by gently twisting and pulling out of the rubber grommet. See **Figure 4**.

Note: Leave the Air Filter Minder connected to the attached electrical connector and set aside.

6. Separate front and rear air filter cover from center filter element. Remove the center filter element and set aside. See **Figure 5**.

Figure 2

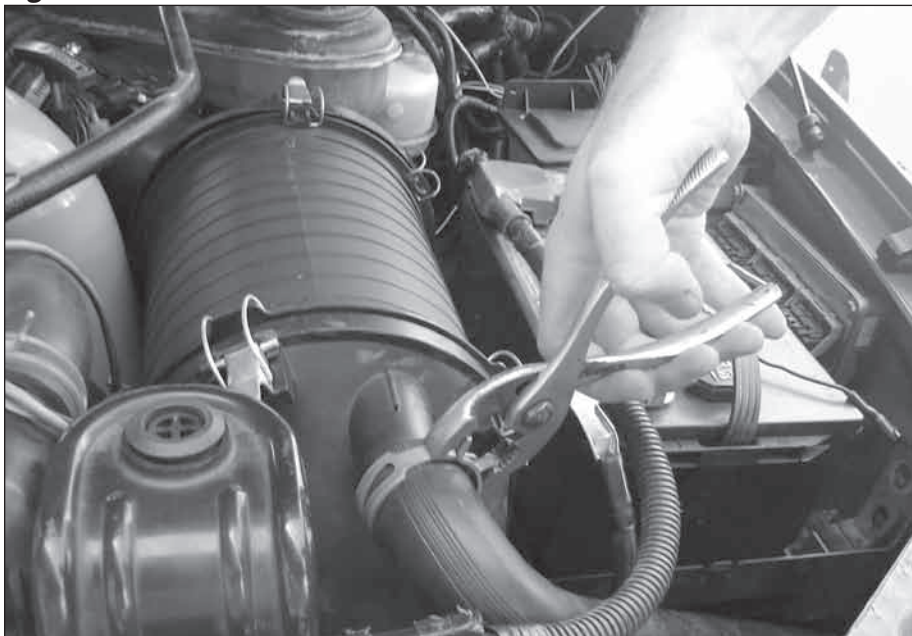

Figure 3

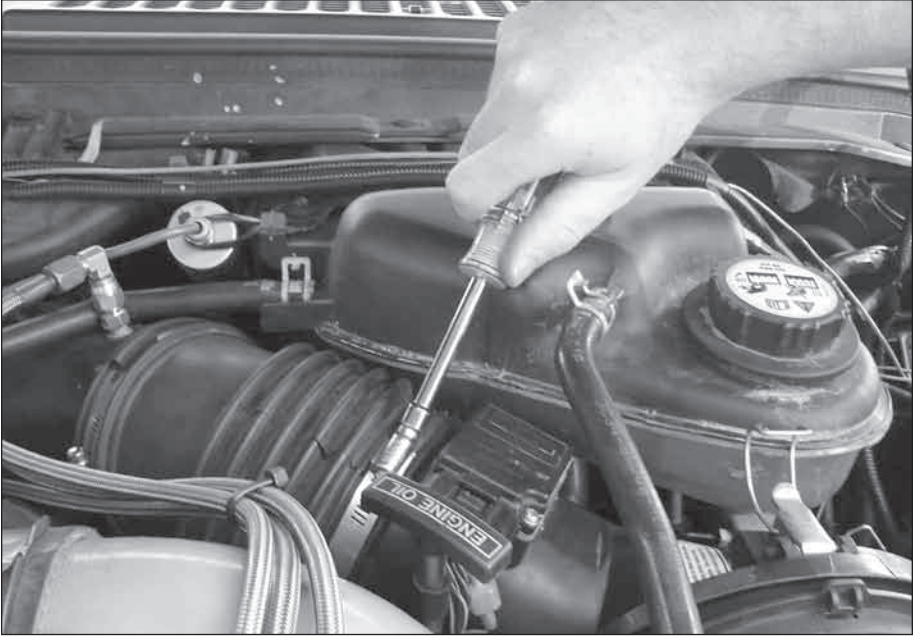

Figure 4

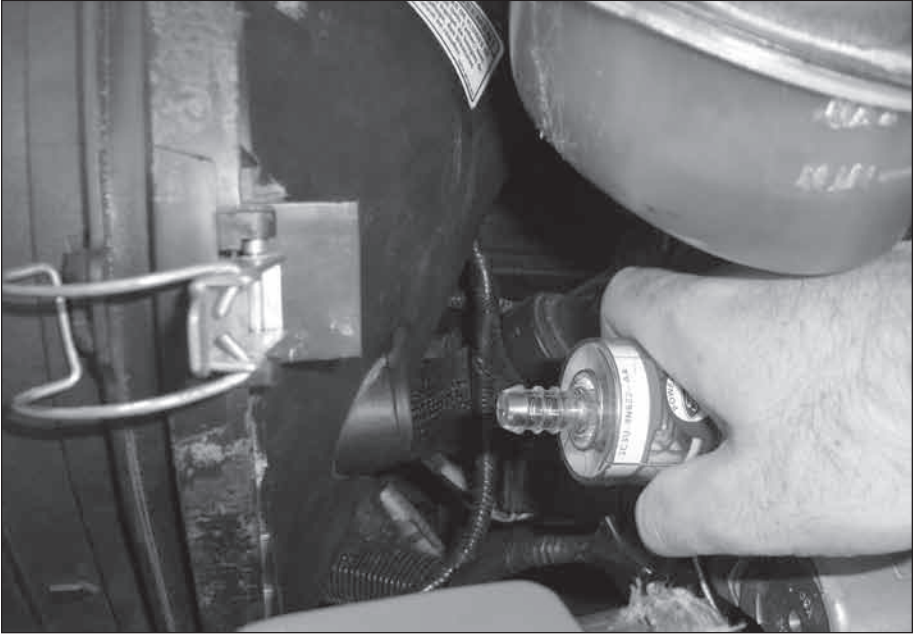
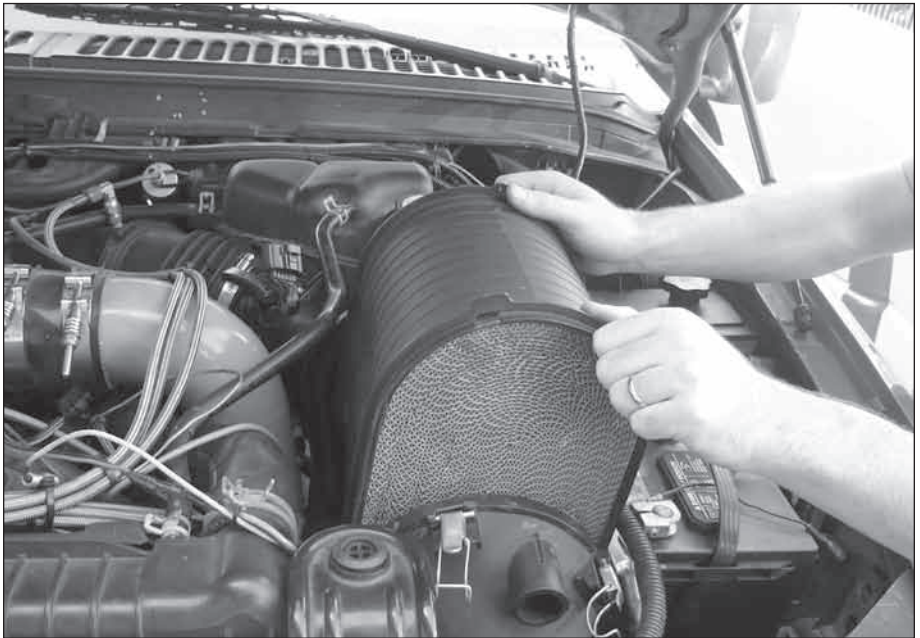

Figure 5



7. Remove the front air cover by withdrawing and lifting out of engine bay.

8. Remove the rear air cover.

Note be careful when handling the rear air cover the MAF/IAT sensor is attached and will be reused.

9. Remove the Torx (T-20), MAF sensor screws using the supplied Banks Torx tool bit. See **Figure 6**.

10. Carefully remove the MAF/IAT sensor and set aside.

11. Locate the supplied Banks MAF sensor gasket or Banks IAT sensor grommet and the Banks Intake tube from your kit. Install the supplied gasket or grommet as shown in **Figure 7A** and **Figure 7B**.

12. Install the MAF sensor to the Banks intake tube using the supplied screws.

Note: Do not over tighten the screws.

Or, install the IAT sensor into the grommet by inserting in the sensor until it seats flush on the grommet.

13. Locate the previously removed factory rear air inlet cover and remove the rubber grommet used to secure the air filter minder.

14. Install the rubber grommet to the Banks Intake tube.

15. In the engine compartment towards the front-top radiator brace, on the (drivers-side), locate the long radiator/intercooler fastener bolt. See **Figure 8**.

16. Remove the wire harness loom tie down from the long bolt.

17. Remove the long bolt using a 10mm wrench.

18. Remove the wire harness loom fastener from the wire harness.

Figure 6



Figure 7A

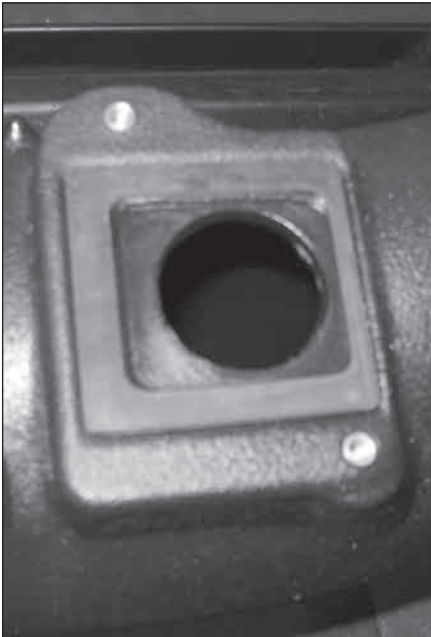

Figure 7B

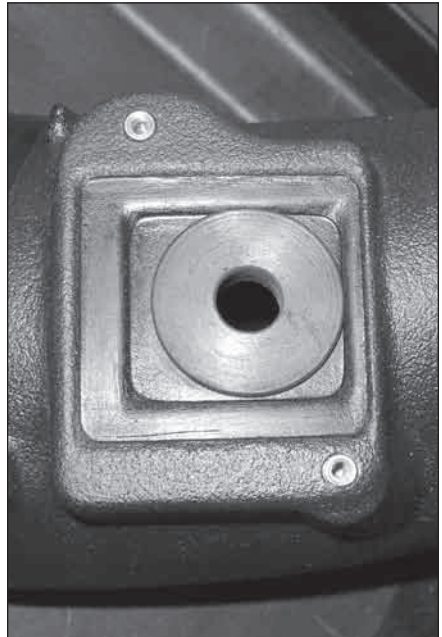

Figure 8

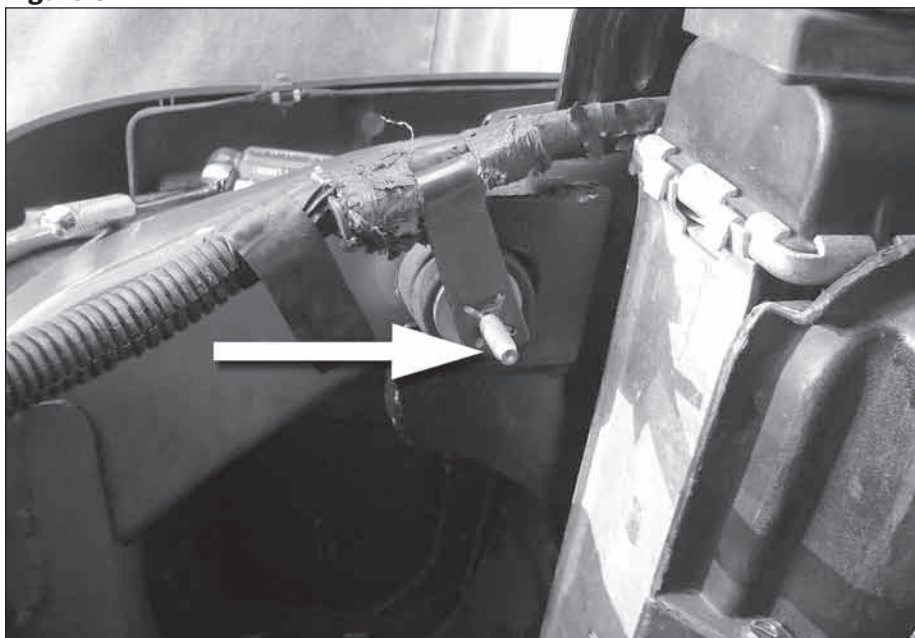

Figure 9



Figure 10



19. Using the supplied large washer and bolt install and tighten the radiator/intercooler fastener. See **Figure 9**.

20. Locate the Banks air filter housing and drop in and insert the inlet then fit the air housing feet into place on the factory grommets. See **Figure 10**.

21. Feed the rear Banks intake tube through the opening of the Banks air filter housing and fasten into position using the supplied screws. See **Figure 11** and **Figure 12**.

22. Insert the intake tube into the factory bellows and tighten the hose clamp.

23. Connect the MAF/IAT connector to the MAF/IAT sensor.

24. Insert the air filter Minder into the intake tube. See **Figure 13**.

25. Place air filter hose clamp on air filter. Do not tighten the clamp.

26. Drop in Banks air filter with hose clamp and fit air filter lip onto intake tube securing that the air filter is inserted properly. Using hand tools tighten the air filter hose clamp. See **Figure 14**.

Warning: Filter may come loose at connection point due to oil residue. Clean the air filter connection points with a non-oil based solvent such as Acetone, Mineral Spirits, Denatured Alcohol, or Lacquer Thinner. Read and follow the manufactures operation instruction for non-oil based solvent cleaner. Be careful not to apply cleaner to cotton filter media or damage to media may result.

Figure 11

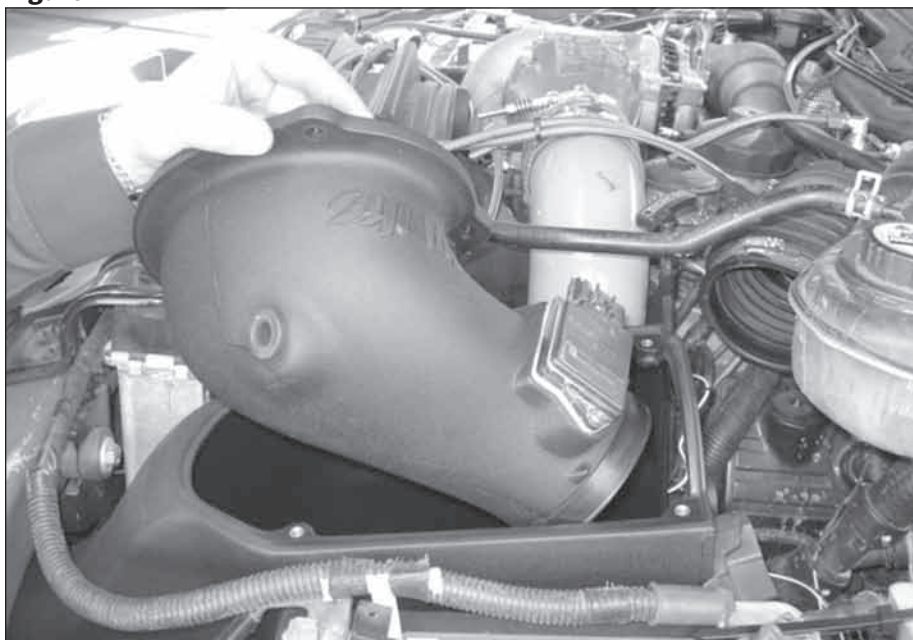

Figure 12



Figure 13

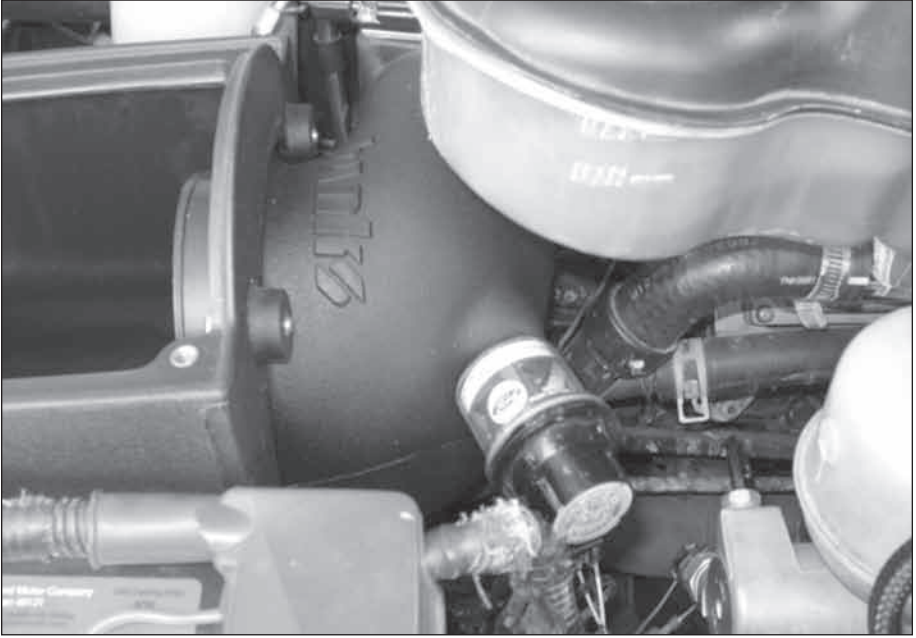

Figure 14

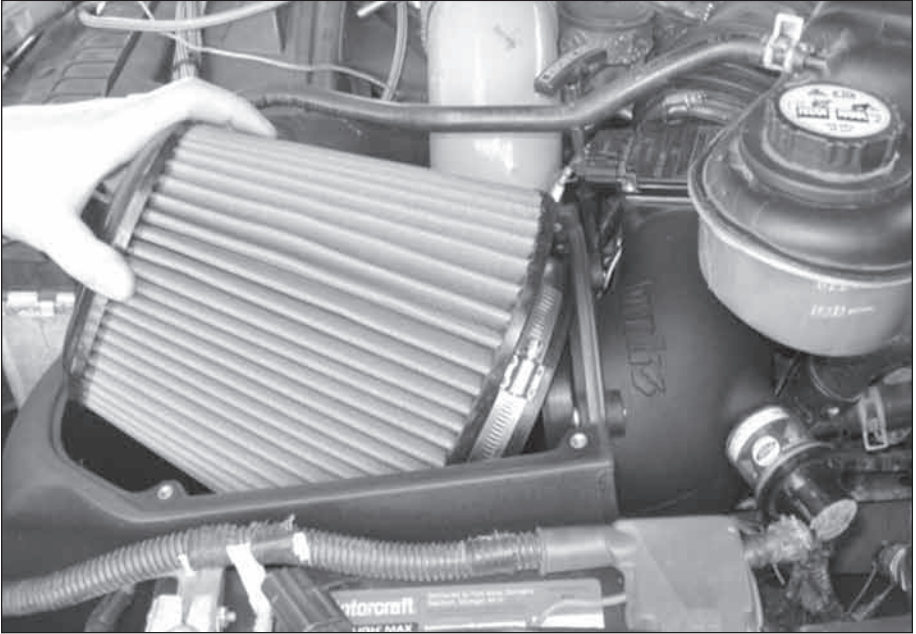
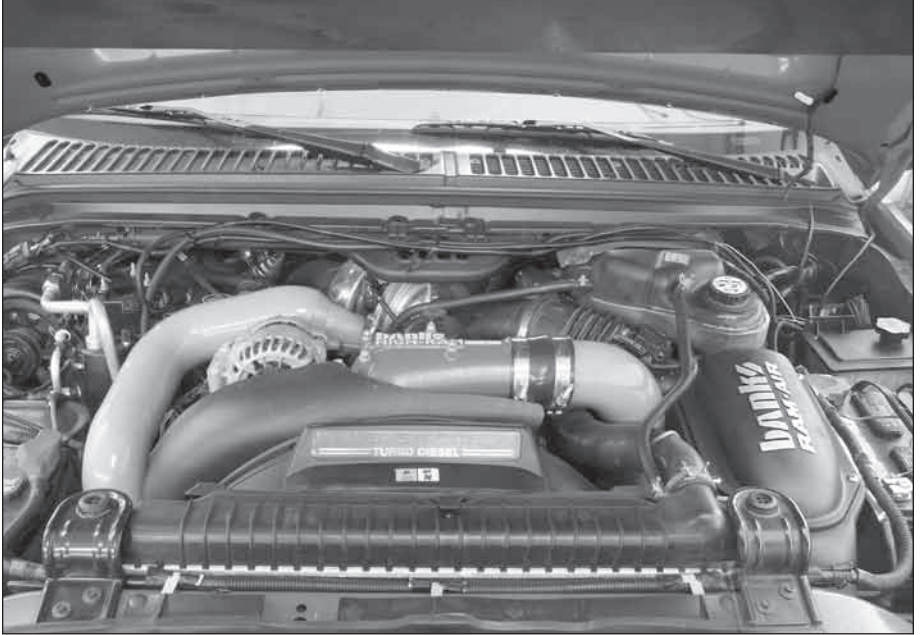

Figure 15



27. Place Banks cover onto air filter housing and secure lid using the supplied Phillips screws.

28. Re-connect battery grounds. You have successfully completed the installation of the Banks Ram-Air Intake system. See **Figure 15**. Make sure to go over all hose clamps for tightness and connectors for a secure fit.

-END, SECTION 2-

Section 3

FILTER MAINTENANCE

Notification

The Banks Ram-Air Filter comes pre-oiled and no oiling is necessary for the initial installation. Service the filter as specified in this Section of the manual.

1. Service Banks Ram Air Filter every 50-100,000 miles on street-driven applications. Service more often in off-road or heavy-dust conditions. If an air-filter restriction gauge is installed, then clean the element when the air-filter restriction gauge enters the restrictive red zone. See **Figure 16**.
2. Use Banks Ram Air Filter cleaning system (part # 90094), available from Gale Banks Engineering to service the Air Filter. Follow the instructions included with the cleaning system to clean and re-oil your Banks Ram

Air Filter. No gasoline cleaning, No steam cleaning, No caustic cleaning solutions, No strong detergents, No high pressure car wash, No parts cleaning solvents. Any of these No's can cause harm to the cotton filter media plus SHRINK and HARDEN the rubber end caps.

CAUTION! Extremely fine dust from agriculture or off-road use will pull the oil from the element. Frequent re-oiling of the element's clean side might be required. Completely service when practicable. Service only with Banks Ram-Air-filter cleaner and Banks Ram-Air-filter oil.

-END, SECTION 3-

Figure 16 Typical air-filter restriction gauge

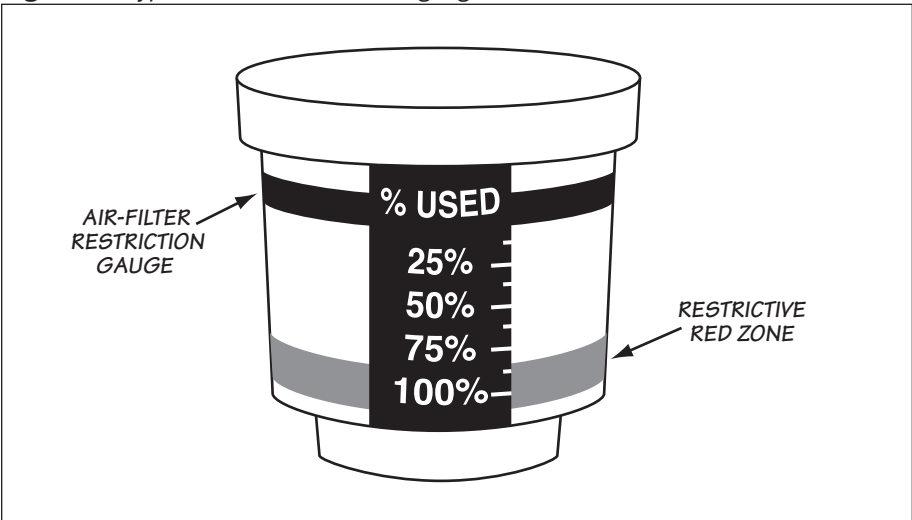

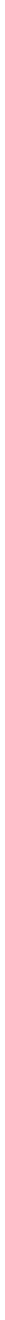



Gale Banks Engineering
546 Duggan Avenue • Azusa, CA 91702
(626) 969-9600 • Fax (626) 334-1743

Product Information & Sales: (888) 635-4565

bankspower.com