



# INSTALLATION INSTRUCTIONS

150207BK / 150207TP

4" LIFT KIT

300 W. Pontiac Way Clovis, CA 93612 Toll free: 1-800-445-3767 Web: www.belltech.com

## 07-15 GM 1500 4WD

Thank you for being selective enough to choose our high quality BELLTECH PRODUCT. We have spent many hours developing our line of products so that you will receive maximum performance with minimum difficulty during installation

Note: Confirm that all of the hardware listed in the parts list is in the kit. **Do not** begin installation if any part is missing. Read the instructions thoroughly before beginning this installation.

**Warning: DO NOT** work under a vehicle supported by only a jack. Place support stands securely under the vehicle in the manufacturer's specified locations unless otherwise instructed.

**Warning: DO NOT** drive vehicle until all work has been completed and checked. Torque all hardware to specified values.

Reminder: Proper use of safety equipment and eye/face/hand protection is absolutely necessary when using these tools to perform procedures!

Note: It is very helpful to have an assistant available during installation.



Note: Please refer to component and hardware parts list before beginning installation to insure all necessary pieces have been supplied and packaged.

### Exceptional Customer Experience Guarantee:

**STOP!** We strive for an exceptional experience for all of our valued customers. If, for any reason, you need assistance with your Belltech products, please do not return the products to the store or website you purchased from. Please call our dedicated experts at (1-800-445-3767) from 6am to 5pm PST.

### RECOMMENDED TOOLS:

- Properly rated floor jack and support stands
- Wheel chocks
- Torque wrench up to 200 ft/lbs. range
- Standard and Metric socket wrench set
- Standard and Metric wrench set
- Tape measure
- Dead blow hammer
- Marking pen
- Safety Glasses

 **DIFFICULTY:** 

 **INSTALLATION TIME:** 6-8hrs + Alignment

# PARTS LIST

<b>KIT CONTENTS (150207BK)</b>		
P/N	Item Description	QTY
LK1003	15-18 GM1500 COMPONENT KIT	1
LK3001	STRUT SPACER KIT	1
LK9400R	LK SHOCK SET	1

<b>KIT CONTENTS (150207TP)</b>		
P/N	Item Description	QTY
LK1003	15-18 GM1500 COMPONENT KIT	1
LK9400F	LK SHOCK SET	1
LK9400R	LK SHOCK SET	1

<b>COMPONENT KIT (LK1003)</b>		
P/N	Item Description	QTY
150200-104	SHORT SPACER (DIFFERENTIAL)	2
150200-105	TALL SPACER (DIFFERENTIAL)	2
150200-202	U-BOLT	4
153201-199	FRONT CROSSMEMBER SPACER	2
150200-201	LIFT BLOCK	2
150207-100D	UPPER CONTROL ARM (DRIVER SIDE)	1
150207-100P	UPPER CONTROL ARM (PASS. SIDE)	1
1500200-100-HW	UPPER CONTROL ARM BUSHING KIT	2
150207-109	SKIT PLATE	1
150207-777	HARDWARE KIT	1



# PARTS LIST

<b>COMPONENT KIT (LK3001)</b>		
P/N	Item Description	QTY
150200-120	STRUT SPACERS	2
LK3001-777	HARDWARE KIT	1
LK3001-888	INSTRUCTIONS	1

<b>COMPONENT KIT (LK9400R)</b>		
P/N	Item Description	QTY
TP2216FF	TRAIL PERFORMANCE SHOCK	2

<b>COMPONENT KIT (LK9400F)</b>		
P/N	Item Description	QTY
27004	TRAIL PERFORMANCE STRUT	2

<b>HARDWARE KIT (LK3001-777)</b>		
P/N	Item Description	QTY
110244	M10-1.25 NYLON LOCK NUT	6
110239	M10 WASHER	6

<b>HARDWARE KIT (150207-777)</b>		
P/N	Item Description	QTY
150200A-777	HARDWARE KIT	1
150207A-777	HARDWARE KIT	1
150200B-777	HARDWARE KIT	1
150200C-777	HARDWARE KIT	1
150200D-777	HARDWARE KIT	1



# PARTS LIST

<b>COMPONENT KIT (150200A-777)</b>		
P/N	Item Description	QTY
110279	M10X1.5-60MM BOLT	4
110280	M10X1.5 NYLON LOCK NUT	4
110239	M10 WASHER	8

<b>COMPONENT KIT (150200B-777)</b>		
P/N	Item Description	QTY
110278	1/4"-20 FLANGED NUT	2

<b>COMPONENT KIT (150200C-777)</b>		
P/N	Item Description	QTY
110276	M12x1.75-110M BOLT	4
110277	M12x1.75 FLANGED NUT	4

<b>COMPONENT KIT (150200D-777)</b>		
P/N	Item Description	QTY
110240	9/16"-18 NYLON LOCK NUT	8
110241	9/16" WASHER	8

<b>COMPONENT KIT (150207A-777)</b>		
P/N	Item Description	QTY
110271	SELF TAPPING BOLT(5/16"x1" )	2
110272	5/16" WASHER	2



**CAUTION!**

**BEFORE INSTALLING, ENSURE THAT YOU HAVE THE RIGHT KIT FOR YOUR APPLICATION.  
FAILURE TO DO SO WILL RESULT IN POOR FIT AND FAILURE OF PARTS  
IF NOT CORRECT, RETURN AND ORDER PROPER KIT.**

If your vehicle came equipped with either the aluminum upper control arm or stamped steel upper control arm commonly equipped (but not limited to) to the 15-18 models the proper kit is following:

**150200BK / 150200TP for the 4" lift kit**

The CHEVROLET Stamped Steel Upper control arm superseded the Aluminum upper control arm.



**ALUMINUM UPPER CONTROL ARM**



**STAMPED STEEL UPPER CONTROL ARM**

If your vehicle came equipped with the cast steel upper control commonly equipped (but not limited to) to the 07-15 models the proper kit is following:

**150207BK / 150207TP for the 4" lift kit**



**CAST STEEL UPPER CONTROL ARM**

## 1) KIT PREPERATION

- a) Before beginning the install process, measure the hub to fender heights for your vehicle so you can compare the resulting height to the original. Measure vertically from the center of the wheel to the inner edge of the fender. Record the results here:

LF: \_\_\_\_\_ RF: \_\_\_\_\_ LR: \_\_\_\_\_ RR: \_\_\_\_\_

- b) Park the vehicle on a smooth, level concrete or seasoned asphalt surface and activate the parking brake. Block the REAR wheels of the vehicle with appropriate wheel chocks; making sure the vehicle's transmission is in 1st gear ( manual) or " Park" (automatic).

! It is very important that the vehicle is properly supported during this installation to prevent personal injury and chassis damage. Make sure that the support stands are properly placed prior to performing the following procedures. We **DO NOT RECOMMEND** using wheel ramps while performing this installation. !

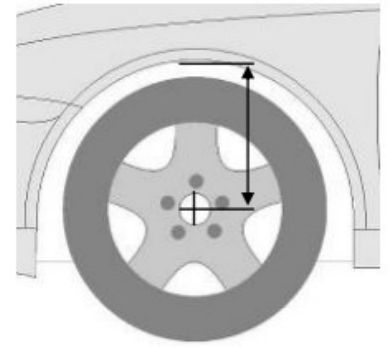

## 2) FRONT INSTALL INSTRUCTIONS

- a) Jack up the front of the vehicle. Place jack stands under the frame rails and lower onto jack stands letting the front suspension hang.
- b) Remove the wheels. **(PHOTO 1)**
- c) Using a 21mm wrench, remove the tie-rod nut. Strike the side of the mount with a dead-blow hammer to dislodge the tie rod end. A 10mm wrench may be needed if the ball joint is spinning. **(PHOTO 2)**
- d) Place a jack underneath the lower control arm to support the assembly and loosen the top and bottom control arm bolts to allow the control arms to move more easily. Do not remove these bolts at this moment.
- e) Remove the ABS sensor wire from the plastic clip. Remove the bracket from the control arm using a 10mm wrench. **(PHOTO 3)**  
Note: The rotor and caliper can be removed for easier access.
- f) Remove and unplug the ABS sensor wire from the spindle as using a 5mm Allen. **(PHOTO 4)**
- g) Using a 15 mm wrench and socket, disconnect the sway bar. **(PHOTO 5)**

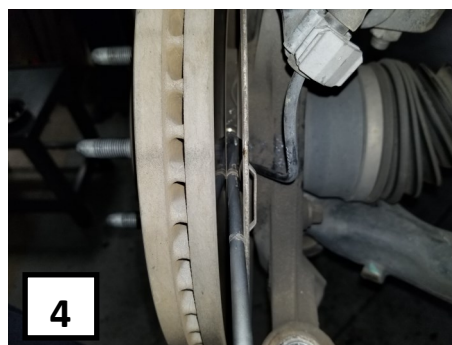

## 2) FRONT INSTALL INSTRUCTIONS CONTINUED

- h. Support the spindle while removing the upper ball joint nut using an 18mm wrench. Strike the spindle on the designated bosses to help separate the upper control arm from the spindle. Be careful, the upper control arm could be under tension. **(PHOTO 6)**
- i. Remove the factory strut by removing the three top bolts using a 18mm socket and the lower two bolts using a 15mm socket. Keep the top hardware. The lower hardware will be replaced.
- j. Mark the orientation and remove the upper control arm cam bolts using a 21mm wrench and socket. Remove the upper control arms from the frame. **(PHOTO 7)**
- k. Install the new control arms after assembling the bushings as shown in the image **(FIGURE 1)**. Use grease liberally and coat all contact surfaces. Ensure that the washers are centered on the sleeves for proper functioning.
- l. Install the upper control arm, and adjust to previous settings. Do not tighten the bolts yet. **(PHOTO 8)**

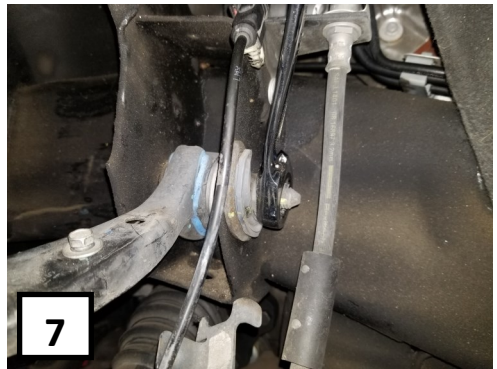

**FIGURE:1 CONTROL ARM BUSHING ASSEMBLY**

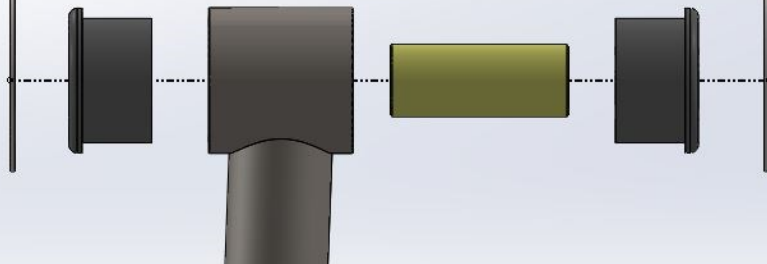

**STOP!** For front strut installation please refer to the following:

**FOR LIFT KIT 150207BK USE STRUT SPACER KIT LK3001 !**

\*\* LK3001 contains 2x 150200-200 strut spacers \*\*

**FOR LIFT KIT 150207TP USE TP STRUT KIT LK9400F !**

\*\* LK9400F contains 2x 27004 Trail Performance Struts \*\*

### TORQUE SPECS

Upper control arms: 120 ft-lbs

Lower control arms: 150 ft-lbs

Lower strut mount: 50 ft-lbs

Upper strut mount: 35 ft-lbs

- m. Once installed within the vehicle use the provided M10 hardware found in the **(150200A-777)** packet to mount to the lower control arm.
- n. Attach the upper ball joint to the spindle using the supplied nut. Torque to 85 ft-lbs.
- o. Reinstall all the brake line brackets, ABS harness and sensor. The provided 1/4-20 flange nuts within the **150200B-777** packet will allow for the ABS line to mount on the newly installed control arms stud.
- p. Reinstall the outer tie rod to the spindle using the factory hardware. Torque to 65 ft-lbs.
- q. Reconnect the sway bar end links back to the lower control arm and sway bar using factory hardware. Torque to 35 ft-lbs.
- r. After performing the front diff spacer installation outlined on the following page, torque all remaining hardware to the following specs.

### 3) DIFFERENTIAL DROP SPACER INSTRUCTIONS

- a) Remove the plastic gravel guard, then support the differential with an appropriate jack. **(PHOTO 9)**
- b) Remove the crossmember located underneath the differential, this will allow for more room to work, as the differential will need to be trimmed to prevent interference with the crossmember. **(PHOTO 10)**
- c) Trim the differential to create a tolerance between it and the crossmember using a reciprocating saw or angle grinder. Reference the image for a visual reference. Your vehicle may need more, or less trimming. **(PHOTO 11)**
- d) Locate and loosen the four 21mm bolts that fix the differential to the frame. Reference the four images on the last page for detailed locations and the following 2 steps.
- e) Continue by removing one bolt at a time, with enough space to slide each spacer between axle and frame, making sure to reinsert and thread in the new supplied *M12* hardware found in **150200C-777** before removing the next bolt. The longer spacers will mount towards the front of the vehicle while the shorter spacers will mount towards the rear. See Page 4 for reference
- f) When all four spacers and bolts have been reinstalled. Torque the bolts to **50 ft-lbs.**
- g) Test fit the crossmember. If it interferes with the differential refer back to step “c”. Reinstall the crossmember using factory hardware.
- h) Attach the skid plate (**150207-109**) using OEM hardware and the supplied self tapping bolt for the rear in hardware kit (**150207A-777**) Do not install the main front bolt until after next step. The skid plate will be between the gravel guard and frame.
- i) The plastic gravel guard will need to be trimmed to match the contours of the new skid plate. Please reference the images for instructions on where to cut. Please use the image for reference only and perform test fits. It may need additional trimming. **(PHOTO 12)**
- j) Reattach the plastic skid shield using the factory hardware and supplied special mounting washer (**150200-109A-95**) in hardware kit (**150200-777**). **(PHOTO 13)**
- k) **Do not forget to finish Step “r” in the front install instructions.** (Previous page)

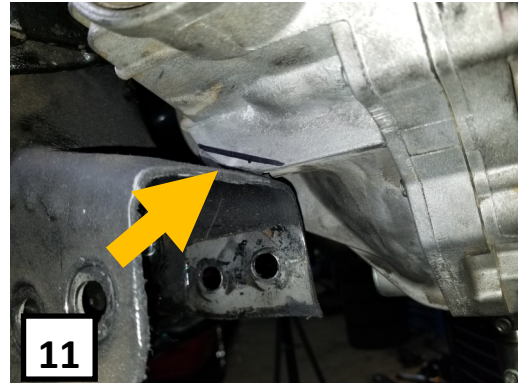
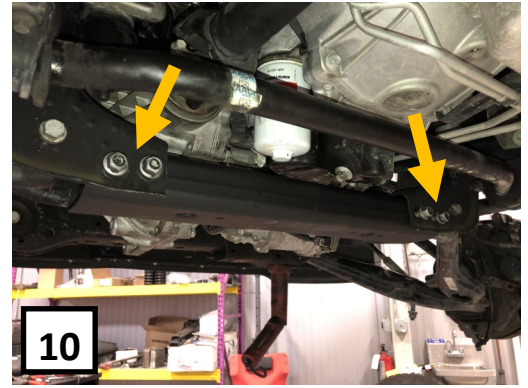
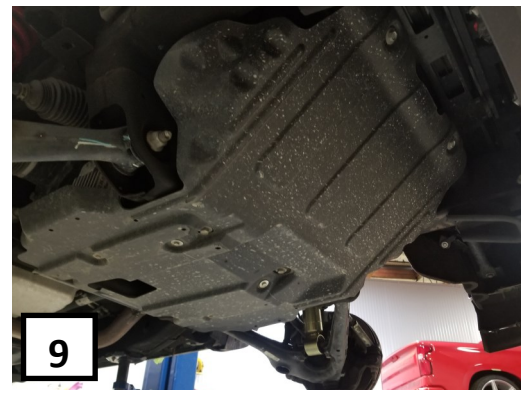



#### 4) Rear Lift Installation

- a) Chock the front wheels to prevent the vehicle from moving while the rear end is lifted
- b) Jack up the rear of the vehicle from the differential
- c) Place jack stands under the frame rails and lower the vehicle onto the jack stands carefully.
- d) Remove the wheels.

e) Remove the factory shock absorbers using a 21mm wrench & socket. The factory hardware will be reused. **(PHOTO 14)**



f) Remove the factory U-bolts by evenly undoing the nuts using a 21mm socket, then remove the factory blocks. Slowly lower the axle using the floor jack to allow for the new 3" block to be installed. **(PHOTO 15)**

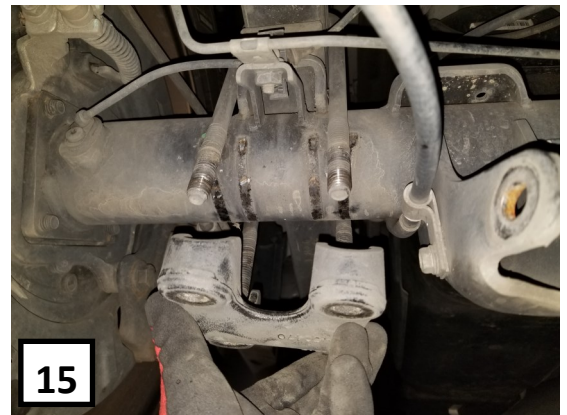

g) Install the block on the factory spring pad with the flat part of the block on the spring and the tapered end towards the front. Jack up the axle to meet the springs, making sure to align the center pin.

h) With the floor jack applying slight pressure to the rear axle to keep the pin aligned, install the new supplied U-bolts in component kit **(LK1001)** and using hardware kit **(150200D-777)** for the U-bolt, tighten in a crossing pattern, using a 7/8" socket. Torque to 110 ft\*lbs **(PHOTO 16)**

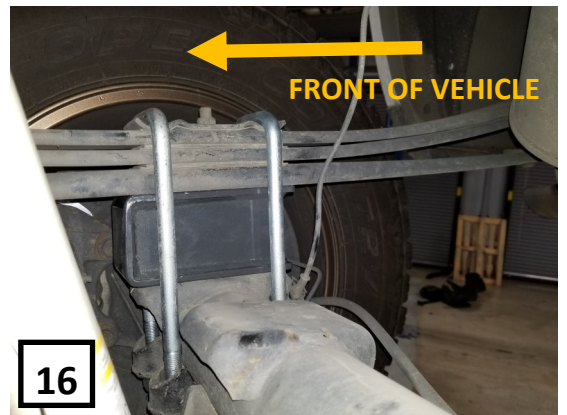

i) Locate the new shock absorbers in kit **LK9400R**, that contains two **BELLTECH TRAIL PERFORMANCE TP2216FF** shocks. Install the shock absorbers in the factory mounting locations using the factory hardware. Tighten using a 21mm wrench & socket. **(PHOTO 17)**



j) Install the tires/wheels.

k) Jack up the vehicle to remove the jack stands. Remove the jack stands and lower the vehicle to the ground.

## 4) Post Install

- a) Check that all components and fasteners have been properly installed, tightened and torqued.
- b) Check brake hoses, and other components for any possible interference.
- c) Torque lug nuts to OEM ( factory) specifications.
- d) Test drive the vehicle in a remote location so that you can become accustomed to the altered driving characteristics and handling. Be aware that the vehicle will handle substantially different now that it has been modified.
- e) We recommend the vehicle be taken to a qualified wheel alignment facility to be realigned to factory specifications after completing the install.
- f) Installation is complete. Check ALL of the hardware and re-torque at intervals for the first 10, 100, 1000 miles.

**Driver's Side Front Spacer**



**Passenger's Side Front Spacer**



**Driver's Side Rear Spacer**



**Passenger's Side Rear Spacer**