



**DOWNLOAD COLOUR  
INSTALL MANUALS AT  
[www.bddiesel.com](http://www.bddiesel.com)**



# **BD Diesel Ford 3.5L Manifold**

**HD replacement manifold set**

<b>1043001</b>	<b>Exhaust Manifold Pair</b> 2011-2016 Pickup
<b>1043002</b>	<b>Gasket Install Kit</b> 2011-2016 Pickup
<b>1043003</b>	<b>Driver Side Exhaust Manifold</b> 2011-2016 Pickup
<b>1043004</b>	<b>Passenger Side Exhaust Manifold</b> 2011-2016 Pickup

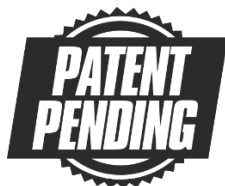





**Manifold Flange Design!  
&  
Stud and Spacer Arrangement!**

If sourcing gaskets separately keep in mind that the BD Diesel exhaust manifolds utilize the late model design turbo mounting gaskets from the 2013-2016 models which is backwards compatible to 2011 models. Ford #(CL3Z-9450-A, CL3Z-9450-B)

This kit has only been test-fit on the F-150 Pickup. Fitment on any other vehicle cannot be guaranteed. This kit will NOT fit 2017+ F-150 pickups.

## Kit Contents

1043001 (Manifold Pair)		
1403060	1403061	1403064 & 1403065
		
Manifold; Passenger Side 11-16	Manifold; Drivers Side 11-16	Gaskets; Exhaust Manifold Pair
<b>Qty: 1</b>	<b>Qty: 1</b>	<b>Qty: 1</b>

1403009	FT-11559037	FT-11141221	1462433	1130055
				
Spacer; Ford Manifold	Stud; M8x1.25x40	Nut; M8x1.25 Lock Flange	Stud Install Tool; M8x1.25	Nut; M8x1.25
<b>Qty: 22</b>	<b>Qty: 22</b>	<b>Qty: 22</b>	<b>Qty: 1</b>	<b>Qty: 2</b>

1043002 (Gasket Install Kit)			
BC3Z-6A968-C	W716667-S900	W715673-S900	FT-90702
			
Fitting; -6 ORB to 3/8" QC	Stud; Ford Downpipe	Bolt; Ford M8x1.25 - 30mm	Nut; M10x1.5 Flange
<b>Qty: 4</b>	<b>Qty: 4</b>	<b>Qty: 6</b>	<b>Qty: 4</b>

GS33741	GS33742
	
Gasket Kit; Drivers Side Turbo	Gasket Kit; Passenger Side Turbo
<b>Qty: 1</b>	<b>Qty: 1</b>

<b>1043003 (Driver Side Kit)</b>		
<b>1403061</b>	<b>1403009</b>	<b>1403064</b>
		
Manifold; Driver Side 11-16	Spacer; Ford Manifold	Gaskets; Exhaust Manifold Driver Side
<b>Qty: 1</b>	<b>Qty: 11</b>	<b>Qty: 1</b>

<b>FT-11559037</b>	<b>FT-11141221</b>	<b>1462433</b>	<b>1130055</b>
			
Stud; M8x1.25x40	Nut; M8x1.25 Lock Flange	Stud Install Tool; M8x1.25	Nut; M8x1.25
<b>Qty: 11</b>	<b>Qty: 11</b>	<b>Qty: 1</b>	<b>Qty: 2</b>

<b>1043004 (Passenger Side Kit)</b>		
<b>1403060</b>	<b>1403009</b>	<b>1403065</b>
		
Manifold; Passenger Side 11-16	Spacer; Ford Manifold	Gaskets; Exhaust Manifold Passenger Side
<b>Qty: 1</b>	<b>Qty: 11</b>	<b>Qty: 1</b>

<b>FT-11559037</b>	<b>FT-11141221</b>	<b>1462433</b>	<b>1130055</b>
			
Stud; M8x1.25x40	Nut; M8x1.25 Lock Flange	Stud Install Tool; M8x1.25	Nut; M8x1.25
<b>Qty: 11</b>	<b>Qty: 11</b>	<b>Qty: 1</b>	<b>Qty: 2</b>

## ***Preface (Gasket install kit)***

The kit contains several items that may cause confusion:

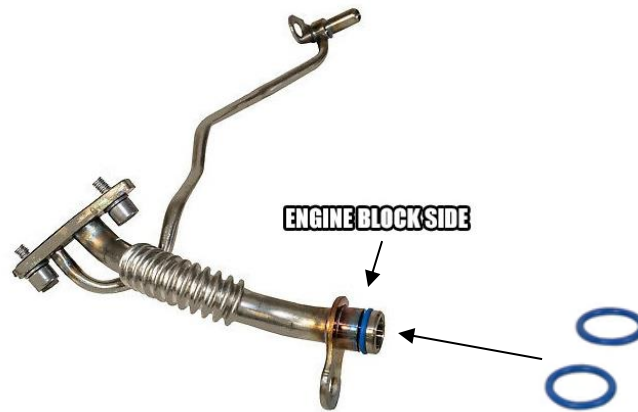

Blue O-rings

The provided blue O-rings are intended for the oil drain hose, while it is not necessary to replace this part, stock OEM O-rings can leak, and we have provided this part if you wish to replace the O-ring while installing this kit.



Syringe

Two syringes are provided within the kit to pre-lube the turbochargers prior to install. This is intended to eliminate the small amount of the time that the turbo will run dry during first start.

# Introduction

The BD performance exhaust manifold utilizes all 11 exhaust studs instead of only 8 the OEM manifold uses. This helps to prevent the exhaust gasket failure.

The manifold is port matched to the cylinder head to maintain flow efficiency.

New longer exhaust studs and spacers are included to further improve thermal durability and longevity.

# Table of Contents

- Kit Contents .....2
- Preface (Gasket install kit) .....4
- Introduction .....5
- Table of Contents.....5
- Removal .....5
- Installation.....10

# Removal

This removal procedure advises you remove the engine starter instead of removing the AC condenser.

Disconnect both vehicle batteries and position the vehicle safely on a hoist before installation for safety.

Remove both front inner wheel fender liners.

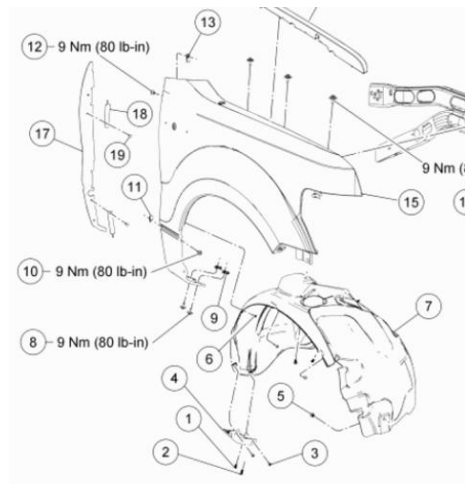

Ensure the cooling system is room temperature and devoid of pressure.

Remove the radiator cap.

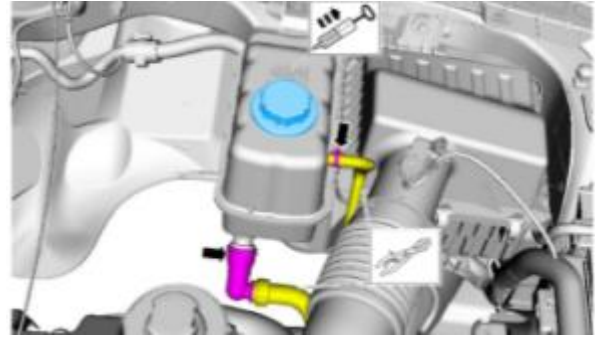

Drain the coolant using the radiator stopcock.

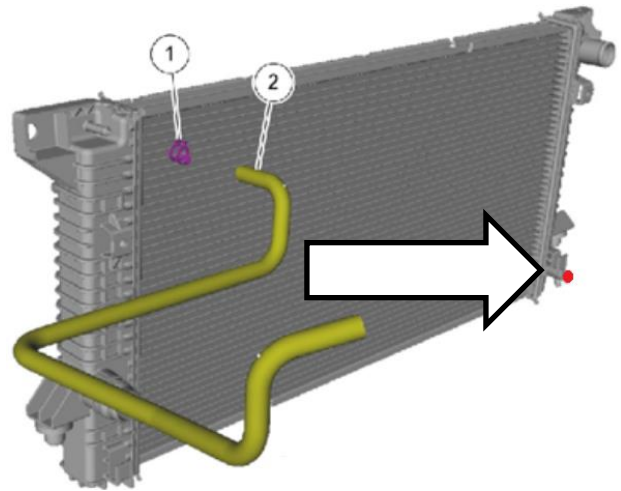

Remove air cleaner box from the turbocharger inlet pipes.

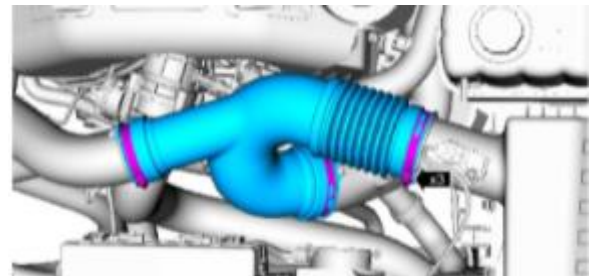

Remove both turbocharger inlet pipes.

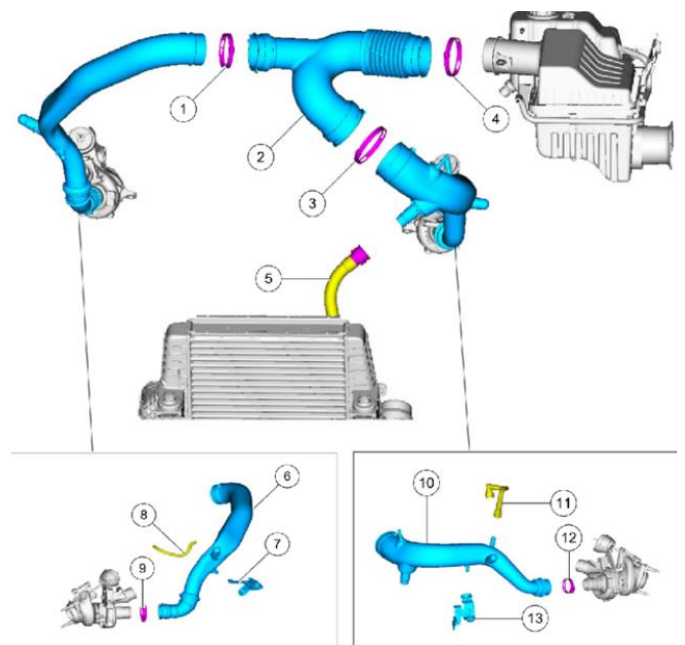

Remove both turbocharger outlet pipes or move them far enough out of the way.

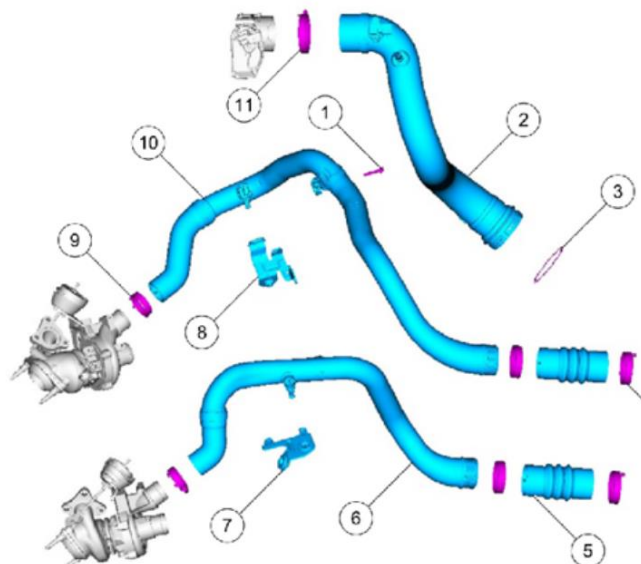

Disconnect the turbo downpipe.

**Notes:**

- The downpipe does not need to be removed.
- The cast exhaust flange mounted to the turbo can be removed after the turbo has been extracted from the vehicle.

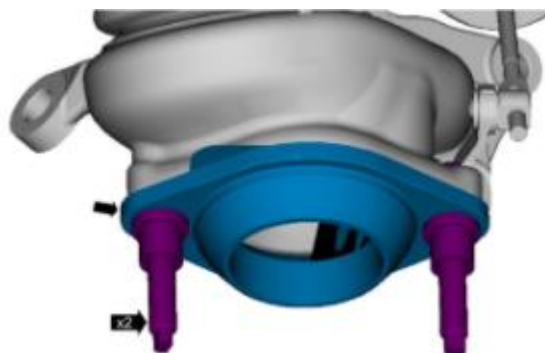

Remove the turbocharger wastegate tube from the wastegate canister.

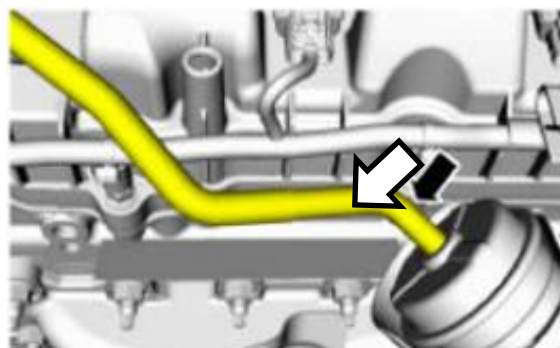

Disconnect the turbocharger coolant return tube.

**Note:** The coolant tube is held on by a C-clip; it may be a good idea to use a 90 degree pick prior to removal. To install, install the C-clip before the installation of the coolant hose.

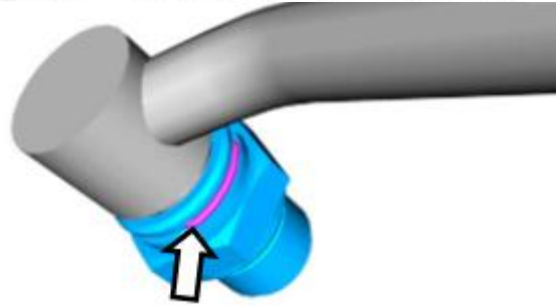
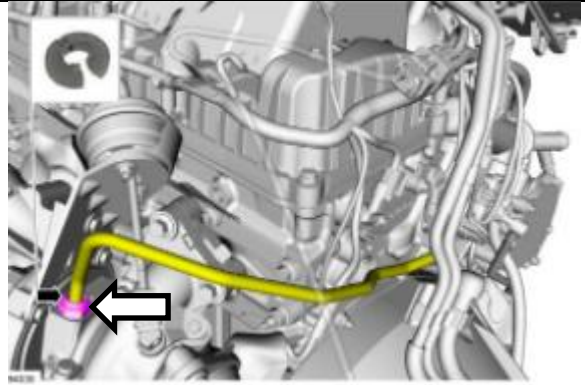

To make removing the coolant tube from the turbo easier, you may need to remove the coolant tube from the back of the motor as well.

If the coolant tube is removed, inspect the coolant fitting before reinstalling the tube.

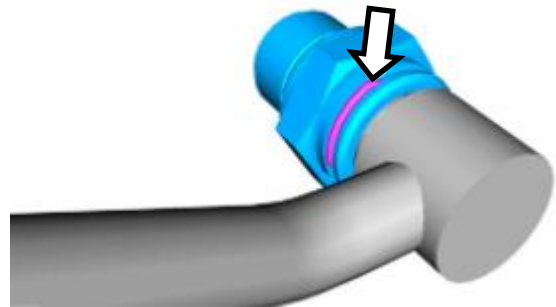
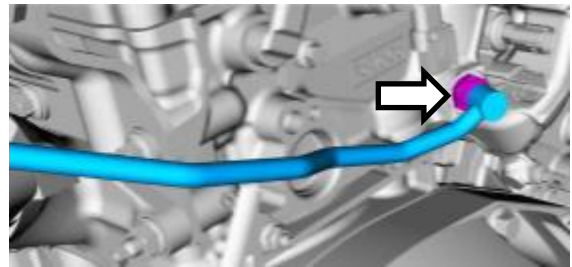

Remove the turbocharger coolant feed tube.





Remove the two bolts that hold the starter in place. This can be dropped down slightly to allow access to the turbocharger drain on the passenger side.

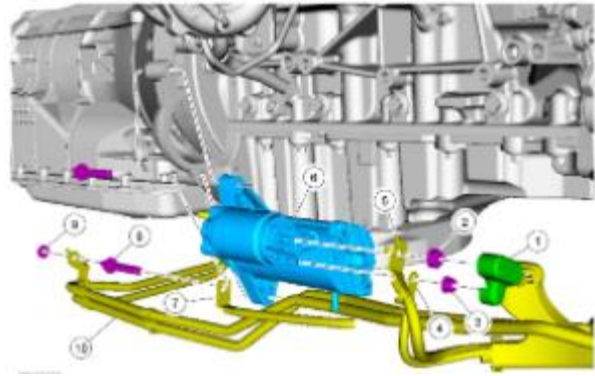

Remove the two bolts holding the oil feed and drain lines affixed to the turbo.

**Note:** If desired, the included blue colored O-ring from the gasket install kit can be installed to the drain pipe, doing so will require the removal of the oil drain pipe from the engine. Otherwise do not remove the drain and feed pipes from the vehicle.

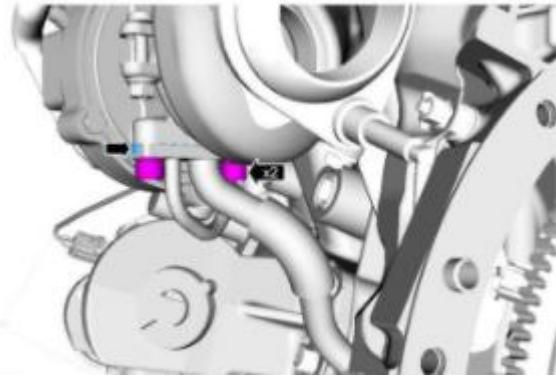

Remove the three M8 bolts holding the turbocharger in place and remove the turbocharger.

**Notes:**

- Cover the oil feed and drain pipe to prevent debris from destroying your turbo.
- Plug or cover the exhaust downpipe to prevent nuts and tools from falling inside and causing significant time delays.

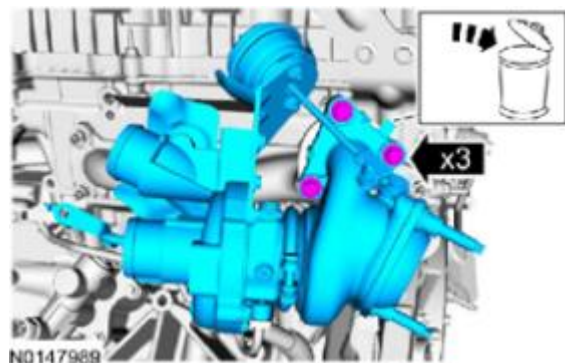

Remove the exhaust manifold and all studs.

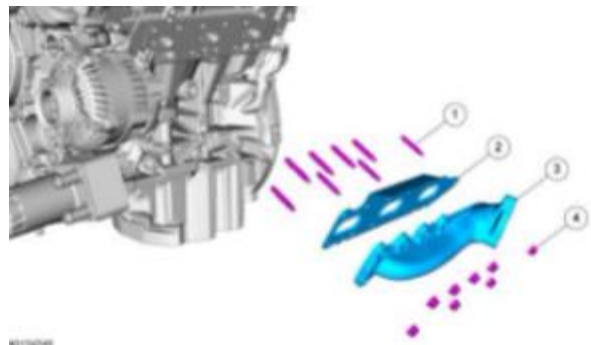

## Installation

Clean and prepare the cylinder head mating surface.



Install the provided M8 studs. Put the **shorter thread end** into the cylinder head.

On the Passenger side, the front lower stud is close to the AC condenser and must be installed first. This one stud will need to use the “double-nut” method (**FT-90702**).

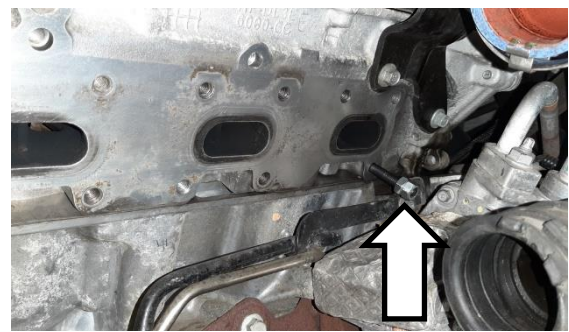

Tighten to **8.8 ft-lb (106 in-lb)**.

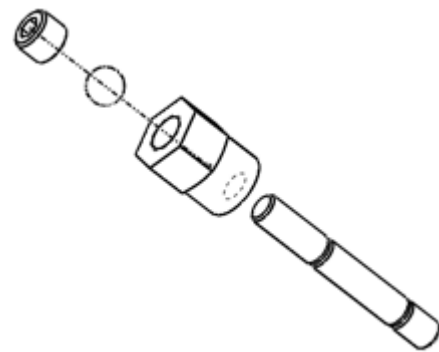

Use the provided M8 install tool (**1462434**) to install the remaining 21 studs.

Tighten to **8.8 ft-lb (106 in-lb)**.



Press the exhaust manifold gaskets on (**MS19921**). The locating tabs must be pressed on carefully to not crease or dent the gasket.



Install and hand-tighten the manifold using the provided spacers (**1403009**) and M8 lock nuts (**FT-11141221**).

**Note:** On the passenger side, there is a tight fit between the AC compressor and the manifold. Ensure this stud is fully seated and properly torqued before trying to install the manifold.

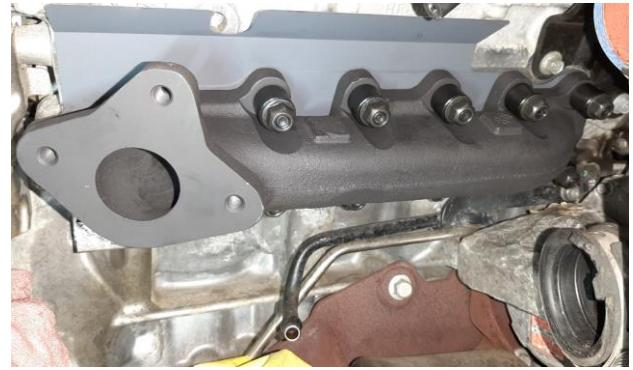

Tighten down the manifold nuts in a 3-step sequence.

Stage 1: Tighten to **14 ft-lb (168 in-lb)**

Stage 2: Tighten to **18 ft-lb (216 in-lb)**. If the nuts rotate more than one turn, ensure the torque wrench is accurate and or the stud has not stretched.

Stage 3: Tighten to **18 ft-lb (216 in-lb)**. Repeat until all nuts are at the desired torque.

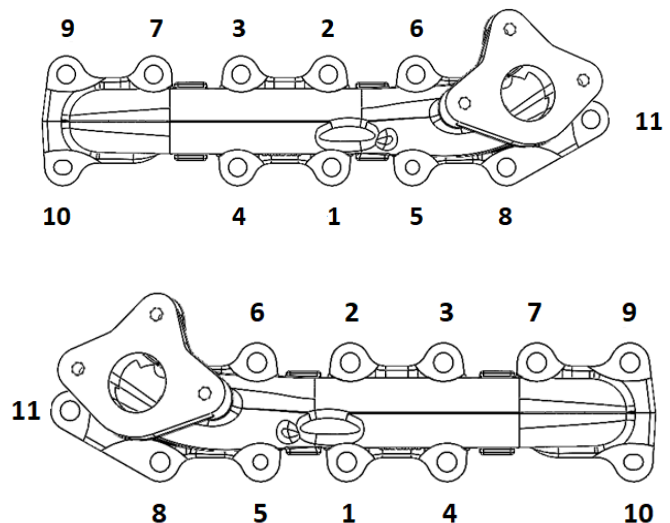

**IMPORTANT!!** Each stud should have at least 1 full thread showing after being torqued to specification.



Affix the turbocharger gasket to the turbo mounting flange.

The new-style gasket allows the gasket to stay on the turbocharger while installing.

Replace all four coolant fittings on the turbocharger. Pre-grease all four fittings to ensure there are no “snags” when installing the coolant tubes.

Tighten to **13 ft-lb (159 in-lb)**.



If installing a new exhaust flange gasket, do so now.

Torque to **30 ft-lb (360 in-lb)**.

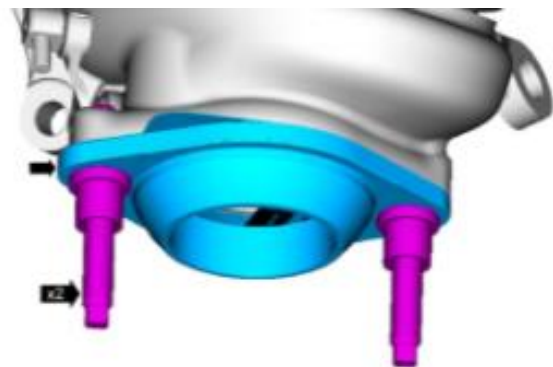

Remove the oil drain and downpipe covers, ensure no debris has fallen into either crevasse. Replace the gasket with the one that is provided in the gasket install kit.

Place a light amount of O-ring grease on the coolant tube.



Mount the turbo in location and use one locating bolt to hold the turbo in position. Inject engine oil into the oil feed hole using the provided syringes from the gasket install kit.

Line up and ensure the coolant feed tube on the far side of the turbo is lined up before completely mounting the turbo using all three provided M8 bolts (**W715673-S900**).

**IMPORTANT!!** The Ford turbocharger mounting bolts are designed to have a slight interference fit when installed into the manifold. The bolt will be finger tight for 3 threads and will require a ratchet be used until fully threaded. This only occurs for the first use of these bolts.

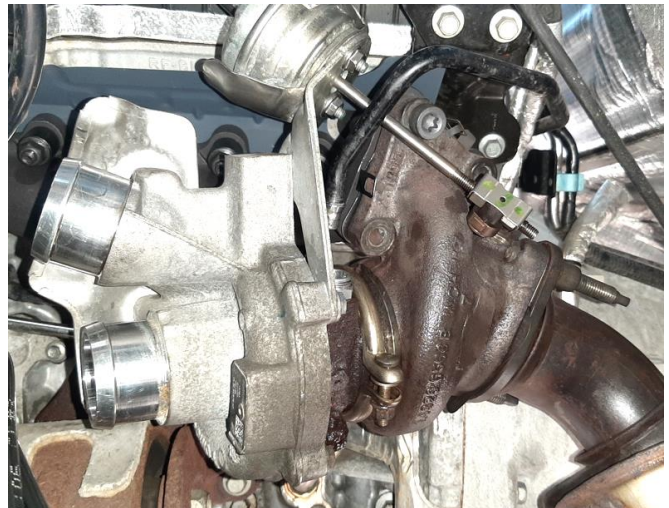

Tighten the three M8 Turbo bolts to **24 ft-lb (288 in-lb)**.

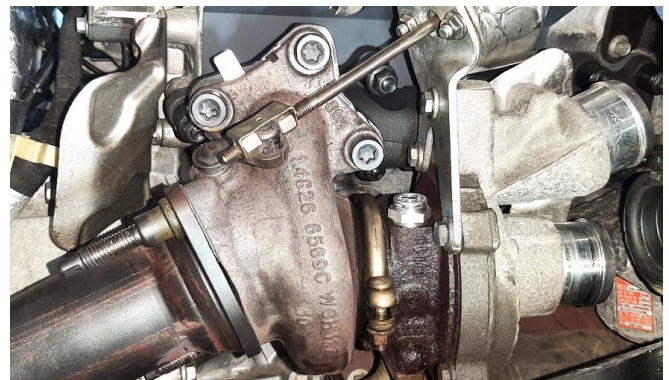

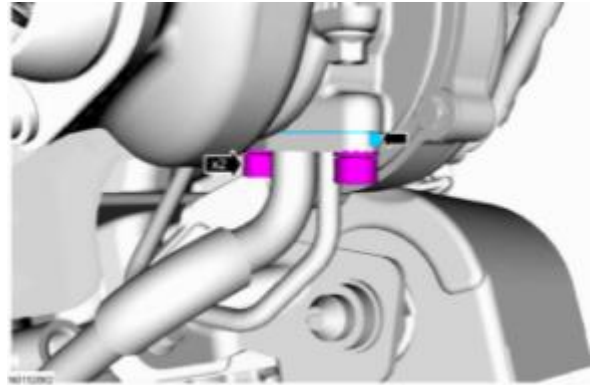

Insert the oil flange gasket. Install and tighten the two oil flange bolts.

**OEM Torque Specification:**  
Torque to **6 ft-lb (71 in-lb) + 30 Degrees**

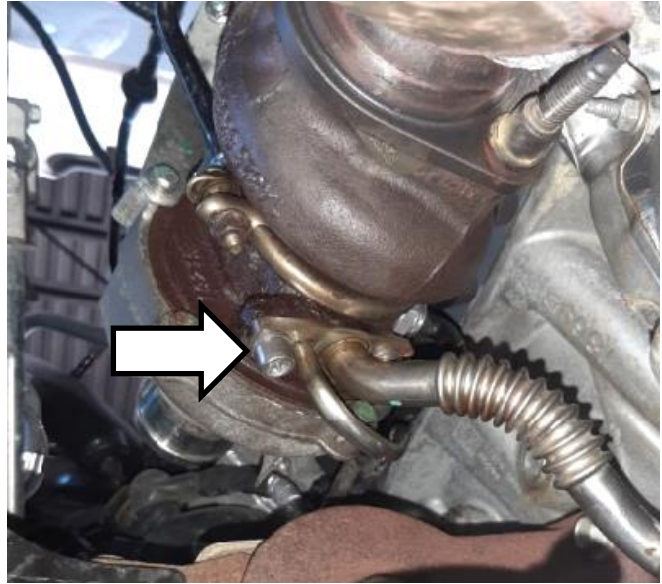

Reconnect all Coolant feed and drain tubes.

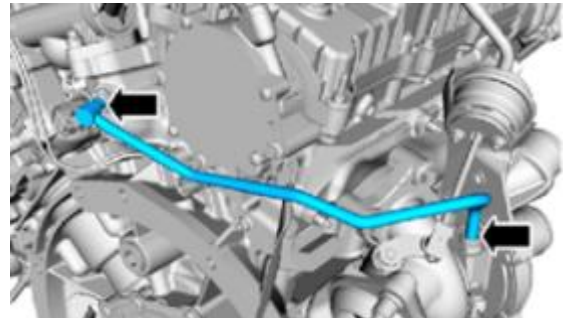

**Note:** If coolant fittings on block are damaged replace with Ford part number **BC3Z-6A968-C**.

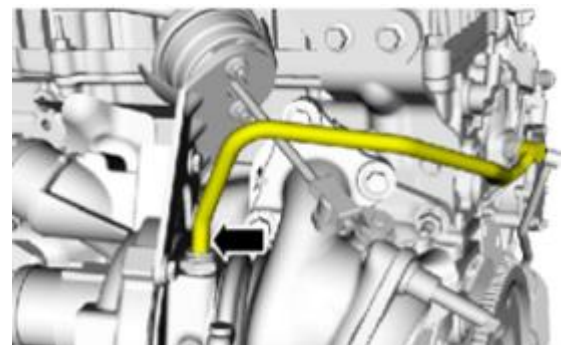

Reconnect the wastegate hose.

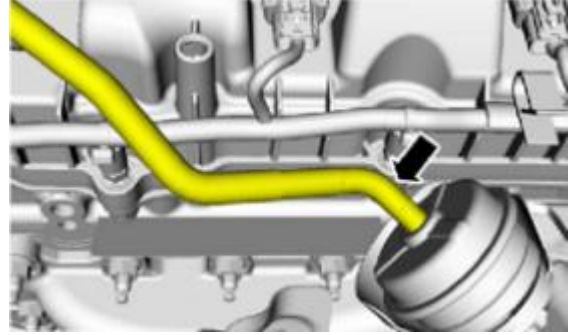

Align and connect the exhaust downpipe flange.

Torque to **30 ft-lb (360 in-lb)**.



Reinstall the starter.

Torque to **35 ft-lb (420 in-lb)**.

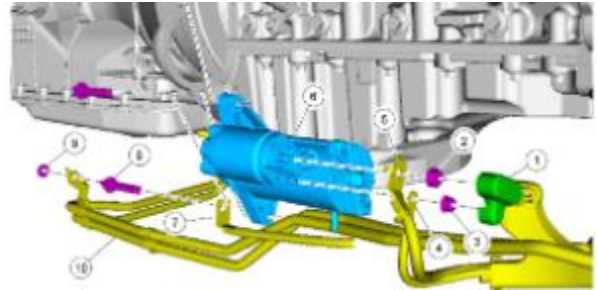

Reinstall and reconnect the turbocharger inlet and outlet tubes.

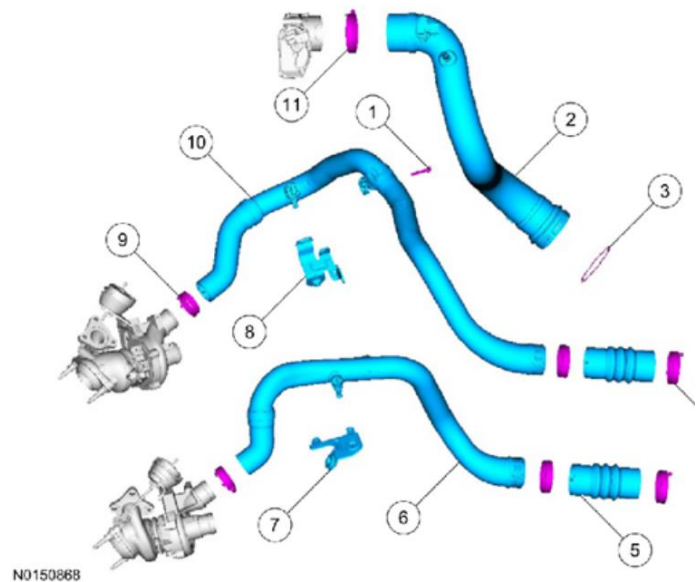

Refer to adjacent pictures for reference

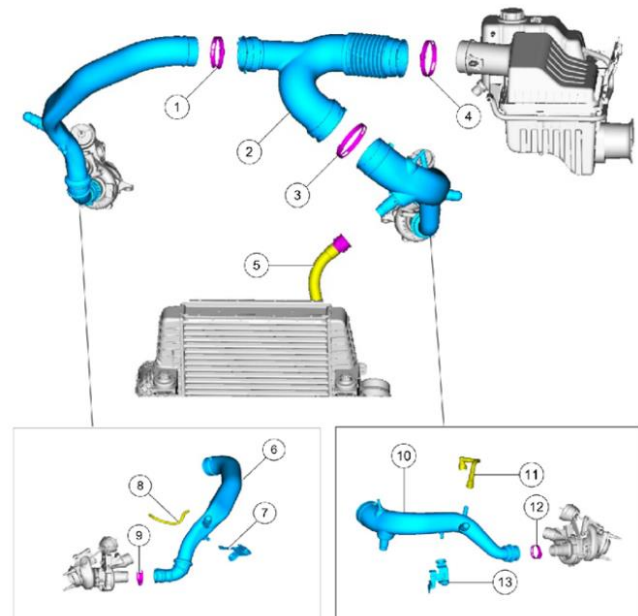

Reinstall both fender liners and front wheels. Confirm all parts have been reinstalled on the vehicle. Once confirmed, Reconnect the battery.

Refill and bleed the coolant system.

**Note:** Use Motorcraft Yellow Antifreeze/Coolant  
 Prediluted: **WSS-M97B57-A2**  
 Concentrated: **WSS-M97B57-A1**



If you do not have a vacuum cooling system filler follow the next steps:

- Fill the radiator through the degas bottle until the coolant level is between the coolant fill level marks. Close the cap.
- Select the maximum heater temperature and blower motor speed settings. Position the control to discharge air at A/C vents in instrument panel.
- Start the engine and allow to idle. While idling, feel for hot air at A/C vents.
- The engine should reach operating temperature. If the air discharge remains cool and the ECT gauge does not move, the engine coolant level is low and must be filled. STOP THE ENGINE. Allow the engine to cool and fill the cooling system.
- Repeat the previous steps as necessary to ensure the coolant system is full.
- Allow the engine to reach operating temperature, hot air should discharge from the A/C vents and the upper radiator hose should feel hot to the touch.
- Shut the engine off and allow the engine to cool.

Check for any leaks from the exhaust system, coolant system or turbocharger oil lines.