

INSTALLATION MANUAL SCHROTH SHR FLEX™

Edition: 02/2016
Part No: EA 15.3

Thank you for choosing our product.

The SHR FLEX is the latest in FHR [Frontal Head Restraint] technology. Designed and developed by the team at SCHROTH, the SHR FLEX provides enhanced comfort, uniquely adapts naturally to different body types and seating positions, and is simple to use versus existing systems on the market.

The new SHR FLEX is a dynamic Frontal Head and Neck Protection [FHR] system with many technological advances. Design highlights include patent pending **dynamic articulation** of the collar, a **rate responsive bump stop** to manage peak neck tension loads, as well as a **stabilizing dual tether system** and **flexible form fitting lower legs** to provide excellent fit and reduce interference with the seat.

The SHR FLEX has been designed with a low collar to be **angle independent** of your seating position. Pliable legs with a low-profile integrated padding system form-fit to your upper body and chest, providing class-leading stability and allow the belts to ride close to the body for enhanced harness performance. Eliminating the external padding systems used by other FHR systems means the SHR FLEX feels planted. We've worked to eliminate the disconcerting floating around feeling that something's loose. And all it takes to clean the SHR FLEX is a simple rinse with warm water and wipe down.

In addition to advanced comfort, the SHR FLEX has **winglets** on the upper collar and SCHROTH's patented **SlipStop system** on the lower legs to assist in belt retention for off-road and rally sport competitors, as well as during secondary impacts.

The SHR FLEX has been designed and tested for use with standard 3" racing belts as well as FHR specific 2" shoulder belts.

This product has undergone and passed SFI Spec 38.1 which evaluates the performance capabilities of Head and Neck Restraint Systems [FHR devices]. It utilizes a dummy seated in a frontal test sled accelerated at 68 G in order to generate high neck forces such as those which may be found during an actual severe frontal crash. Neck tension / compression and the Neck Injury Criterion [Nij] are measured and evaluated against pre-determined injury threshold values. Two direct frontal [0°] impacts and one side [30°] impact are required for certification.

Read and follow all WARNINGS, CAUTIONS and SAFETY INSTRUCTIONS

SAFETY INSTRUCTIONS

- * A SHR FLEX is not a substitute for skill or experience. Do not attempt potentially hazardous maneuvers while wearing a SHR FLEX that you would not attempt without a FHR.
- * SHR FLEX comes in medium and large. Sizing is based on body size and shape. Consult your SHR FLEX reseller for assistance on determining the correct size.
- * Failure to ensure that the SHR FLEX fits correctly will reduce the effectiveness of the FHR and may subject the user to unexpected risks.
- * A cracked, bent, or deformed SHR FLEX or any SHR FLEX worn by a user during an accident or impact should not be used again by anyone. Damage affecting the structural integrity and performance of the SHR FLEX may not be visible to the naked eye.

OVERVIEW



The SHR FLEX is worn over your shoulders and under your safety harness belts.

The centre line [shown in red] defines the lower tip of the SHR FLEX. The shoulder belt length adjusters should rest a maximum of 3" [70 mm] above the tips of the SHR FLEX or a minimum of 1.5" [35 mm] below the tips of the SHR FLEX.



! WARNING

Risk of severe injury or death!
Never modify the hardware, components or body of SHR FLEX. Any modifications to the SHR FLEX may reduce the effectiveness of the product.

HEAD REST CLEARANCE

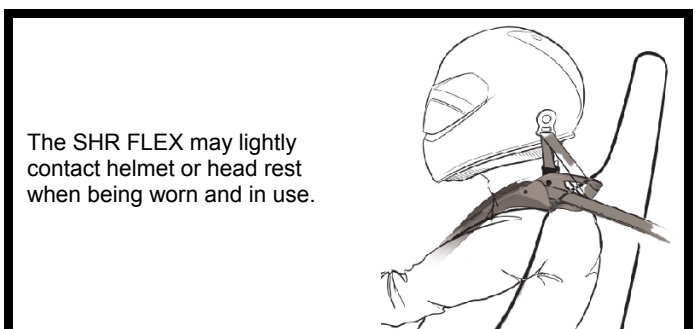

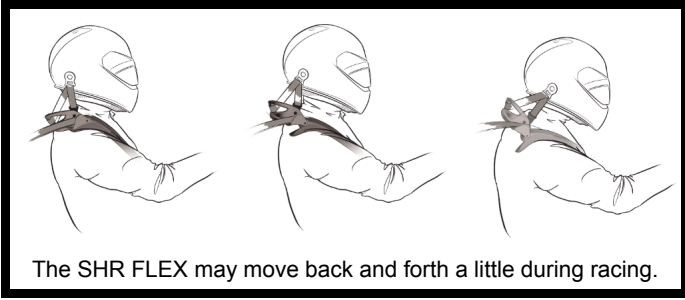

The SHR FLEX may move back and forth a little during racing.

SEAT BELT MOUNTING

Shoulder belt mountings located more than 8" [200 mm] from the back of the user's seat or angled upwards can severely compromise the effective performance of the SHR FLEX and safety harness. Avoid this type of installation. Never use sternum straps in combination with the SHR FLEX.

SHOULDER BELT ANGLES

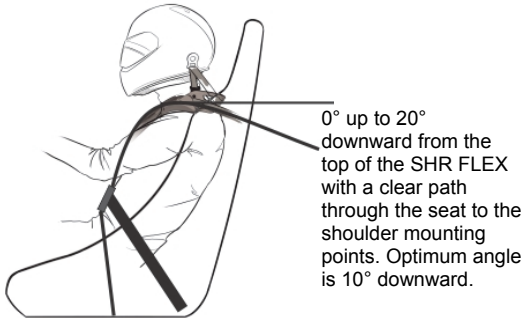

0° up to 20° downward from the top of the SHR FLEX with a clear path through the seat to the shoulder mounting points. Optimum angle is 10° downward.

! WARNING

Risk of severe injury or death!

- Always mount shoulder belts as short as possible to the mounting point. 6" [150 mm] or less is ideal.
- Do not exceed a mounting distance of 8" [200 mm] from the back of the user's seat without mounting and installing the shoulder belts as instructed below.
- Maintain a shoulder belt angle of 0° to 20° DOWNWARD from the top of the SHR FLEX with a clear path through the seat to the shoulder mounting points. Optimum angle is 10° downward.
- NEVER angle the shoulder belts from the SHR FLEX at an upward angle to a mounting point.
- NEVER mount the shoulder belts through seat belt shoulder openings and directly down to the floor behind the seat, without passing over a harness bar at the proper angle.
- Refer to your harness belt installation instructions for further details.

Improper mounting may severely compromise the effective performance of the SHR FLEX and safety harness and may result in severe injury or death.

SHOULDER BELT LENGTHS Always mount shoulder belts as short as possible to the mounting point. 6" [150 mm] or less is ideal. If the shoulder belt mounting point is more than 8" [200 mm] from the seatback, bring the mounting points closer together, touching - or crossing if greater than 20" [500 mm] from the seatback, creating a 20° to 25° angle behind the user's head.

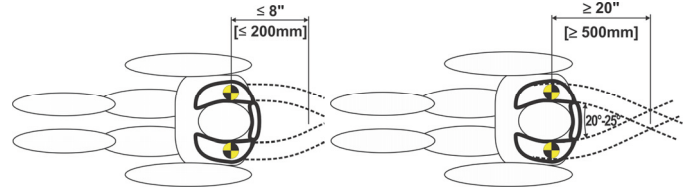

SCHROTH QUICKFIT™ PRO BELTS The SHR FLEX can be used with SCHROTH QuickFit Pro harness belts when installed in a vehicle identified on the belt label in accordance with the QuickFit Pro installation instructions provided for that vehicle. In this approved installation, a downward angle of between 20° to 45° is permitted with attachment to the vehicle's "D" and "E" mounting points. Always ensure that seat belts are clean, undamaged, and in good working order.

! WARNING

DOUBLE SHOULDER BELTS & STERNUM STRAPS

Risk of serious injury!
Do NOT use the SHR FLEX with Double Shoulder belts and/or with any type of Sternum Strap.

SAFETY INSTRUCTIONS

Shorter shoulder belts / mounting points are better!
Target ≤ 8" [200 mm] from back of seat.

SHR FLEX works with 2" or 3" shoulder belts.



3" belts may wrap up SHR FLEX device collar as shown above.

SHR FLEX TETHERS

The SHR FLEX tether system is designed to slide to allow a wide range of movement when worn. The SHR FLEX tethers are not dated. Replace the tethers every 5 years [at the time of device re-certification] or sooner if wear is observed. Check tethers and helmet clips prior to each event / use.

The tethers attach via inserts on the left and right side of the collar.



WARNING

Risk of severe injury or death!
 Use **ONLY** original SCHROTH parts to attach the tether system. Use **ONLY** original SCHROTH SHR FLEX tethers.

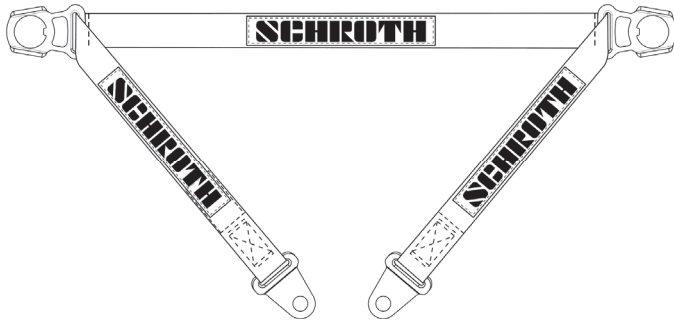

SHR FLEX Tethers are to be installed and routed as shown below.



ANCHOR INSTALLATION INSTRUCTIONS

Helmet / Twist Anchor assembly

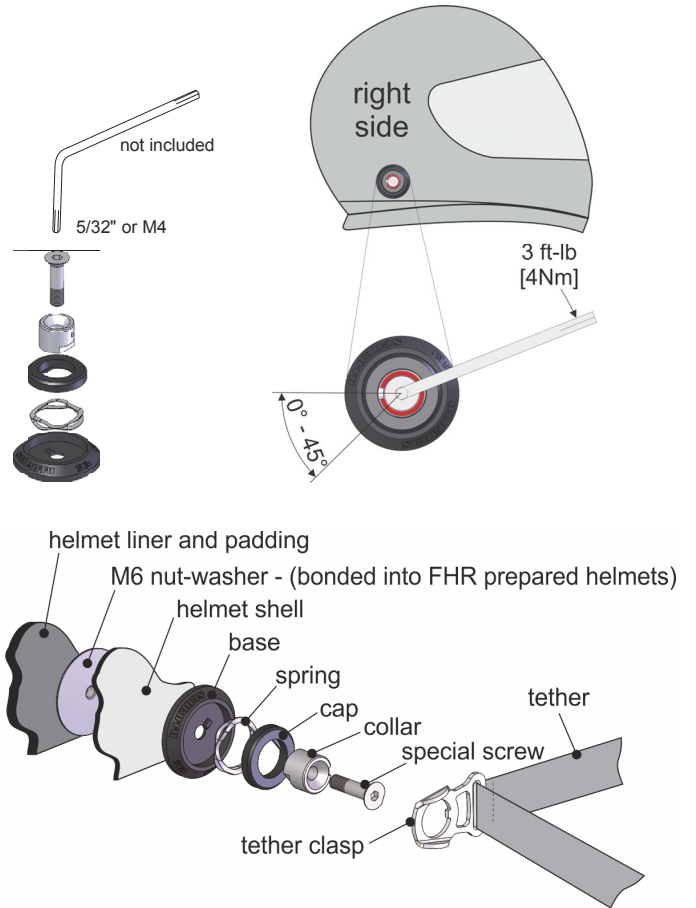

Clip for right side of helmet



Clip for left side of helmet



FHR helmets with factory inserts (M6)

Installation of Twist Anchors into Helmets with Bonded-in Threaded M6 Anchor Terminals

SAH2010, SA2015, FIA 8859, FIA 8860 or FIA 8858 Helmets with bonded-in threaded M6 anchor terminals

You may use one of the helmets marked as certified to the standards listed above for FHR head and neck restraint system use. These helmets have bonded-in threaded M6 terminals or nut-washers [see figure A], making SHR FLEX anchor installation easy.

1) Align the base, spring, cap and collar with hole, engaging the notch in the underside of the cap with the nib on the inside of the base. Insert the special screw through the assembly into the helmet's M6 terminal.

2) Hand tighten until snug, with the tether clasp indexing slot in the twist anchor collar in the desired orientation pointing rearward on the helmet - typically between horizontal and up to 45° down [see figure B]. Twist anchors are "handed" - one fits the left and one fits the right side of the helmet. The tether clasp should rotate DOWN once pushed onto the twist anchor and engaged.

3) Tighten the screw with a 5/32" [4 mm] hexagon socket screw key a 1/4 turn beyond snug [approximately 3 ft-lb (4Nm) of torque] while holding the desired orientation of the twist anchor collar.

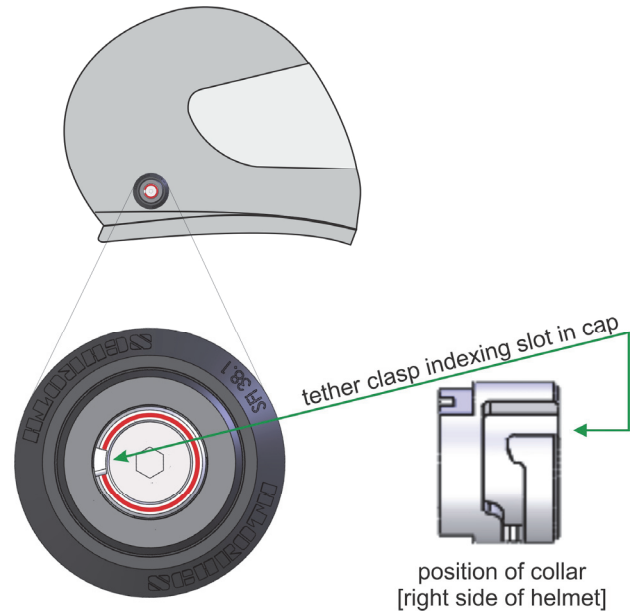

figure B

! WARNING

Risk of serious injury or death!
Use only original SCHROTH SHR FLEX specific parts, including hardware and screws.

Bonded-in threaded M6 anchor terminal on sides of helmet

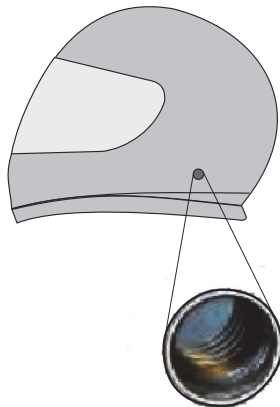

figure A

! WARNING

Risk of severe injury or death!
THREADLOCKER – All SHR FLEX Device anchors are supplied with screws coated with a dry threadlocker compound. Threadlocker is to be used one time only.

Use the screws with threadlocker provided when assembling SHR FLEX helmet anchors.
Failure to use original SHR FLEX screws with threadlocker may result in the twist anchors becoming loose.

Approval stickers - FHR helmets with factory inserts (M6)



Snell SAH2010 decal located inside helmet

Bonded-in terminal on side of helmet

Helmet Compatible with Frontal Head Restraint Systems according to FIA Standard 8858-2010	
Manufacturer Name: Name of Manufacturer	
Serial N°: xxx xxx	
Model : Model Name	
Size : XS	
Date of Manufacture: JAN 2013	

In compliance with: FIA Standard 8860-2010	
Manufacturer Name: Name of Manufacturer	
Serial N°: xxx xxx	
Model : Model Name	
Homologation N° : AH.XXX.XX-X	
Date of Manufacture: JAN 2013	Size: XS

In compliance with: FIA Standard 8859-2015	
Manufacturer Name: Name of Manufacturer	
Serial N°: xxx xxx	
Model : Model Name	
Homologation N° : PH.XXX.XX-X	
Date of Manufacture: JAN 2015	Size: XS

Installation of twist anchors into pre-drilled helmets without M6 terminals (SA2010)

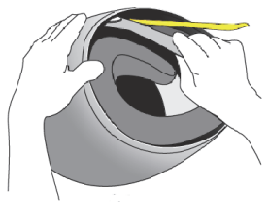

figure C

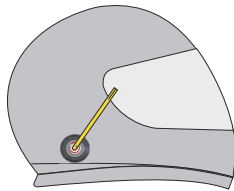

figure D

- 1) Gently pry the helmet liner away from the shell using a thin, blunt instrument [see figure C]. Insert the nut-washer inside the helmet against the shell using a wrench.
- 2) Align the base, spring, cap and collar with the hole, engaging the notch in the underside of the cap with the nib on the inside of the base. Insert the special screw through the assembly into the M6 nut-washer.
- 3) Hand tighten until snug with the tether clasp indexing slot in the twist anchor collar facing rearward on the helmet - typically between horizontal and up to 45° down [see figure B]. The twist anchors are "handed" - one fits the left and one fits the right side of the helmet. The tether clasp should rotate DOWN once pushed onto the twist anchor and engaged.
- 4) Use a 7/16" [11 mm] wrench to hold the nut-washer inside of helmet in position and tighten the screw from the outside [see figure D] with a 5/32" [4 mm] hexagon socket screw key a 1/4 turn beyond snug [approximately 3ft-lb (4Nm) of torque] while holding the desired orientation of the twist anchor collar.

Frequently Asked Questions

I can touch my chin to my chest with the device on. Are my tethers too long?

No. The SHR FLEX Device comes properly adjusted for all drivers. The slack in the tethers is automatically taken up during impact.

What type of shoulder belts work best with a SHR FLEX Device?

Any SFI or FIA approved harness system [e.g., SCHROTH] works with the SHR FLEX Device. Two inch or three inch wide shoulder belts as well as 4-5-6 or more multi-point systems are all fine. Do not use Double Shoulder belts or Sternum Straps with your SHR FLEX Device.

I race on a short track at relatively low speeds. Do I need a SHR FLEX Device?

Yes. Serious head and neck injuries happen at impact speeds as low as 35 mph [55 kph]. On short tracks with tight turns it is easy to be "Q-balled" almost straight into the wall.

Can I share a SHR FLEX Device?

Provided that you are of similar physical size and shape to your partner, chances are good that you can share a SHR FLEX Device. Always use original SCHROTH SHR FLEX Device helmet anchors and hardware.

I have an unusual race car. Do you make a SHR FLEX Device that will fit?

Yes. The SHR FLEX Device can be worn in virtually any vehicle (not just cars) that uses two FIA or SFI shoulder belts as part of the driver restraint harness.

How do I care for my SHR FLEX Device?

SHR FLEX Devices need almost no maintenance but should be kept clean and dry. To protect them, SHR FLEX Devices should be stored out of direct sunlight. They may be cleaned with soapy warm water but avoid solvent-based cleaners. Ensure rubber top surfaces stay clean and free of wear. Tethers should be replaced every 5 years or sooner if wear is observed. Check tethers and helmet clips prior to each event/use.

How long is the SFI certifications acceptable?

Different race series may have different rules regarding age of certifications. As of June 2012, SFI 38.1 requires recertifying your SHR FLEX every 5 years.

Have another question?

eMail us directly at FLEX@schrothracing.com or visit www.schrothracing.com

! WARNING

Risk of serious injury or death!

**Use only original SCHROTH specific hardware and screws.
Use of unapproved parts may result in severe injury or death.**

! WARNING

Risk of injury or death!

**Use care not to damage the helmet shell or EPS liner when inserting the nut-washer into the helmet.
Damage to the EPS liner reduce the overall protection level of the helmet and cause serious injury or death.**

NOTICE

SCHROTH does not recommend using helmets without pre-drilled holes.
REFER TO YOUR SANCTIONING RULES FOR HELMET INSTALLATION.

