

11600**86-89 MAZDA 323 4 DOOR****3/25/2013**

GROSS LOAD CAPACITY WHEN USED AS A WEIGHT CARRYING HITCH: 1,000 LBS. TRAILER WEIGHT & 100 LBS. TONGUE WEIGHT.

*****DO NOT EXCEED VEHICLE MANUFACTURER'S RECOMMENDED TOWING CAPACITY.*****

WARNING: ALL NON-TRAILER LOADS APPLIED TO THIS PRODUCT MUST BE SUPPORTED BY 18050 STABILIZING STRAPS.

**** FAILURE TO PROPERLY SUPPORT NON-TRAILER LOADS WILL VOID PRODUCT WARRANTY****

HAVING INSTALLATION QUESTIONS? CALL TECHNICAL SUPPORT AT 1-800-798-0813

Parts List			
ITEM	QTY	PART NUMBER	DESCRIPTION
1	2	3/8 - 16 x 2	HEX BOLT
2	2	3/8"	FENDER WASHER
3	2	3/8 - 16 x 2 1/2	HEX BOLT
4	4	HFN3816	HEX FLANGE NUT

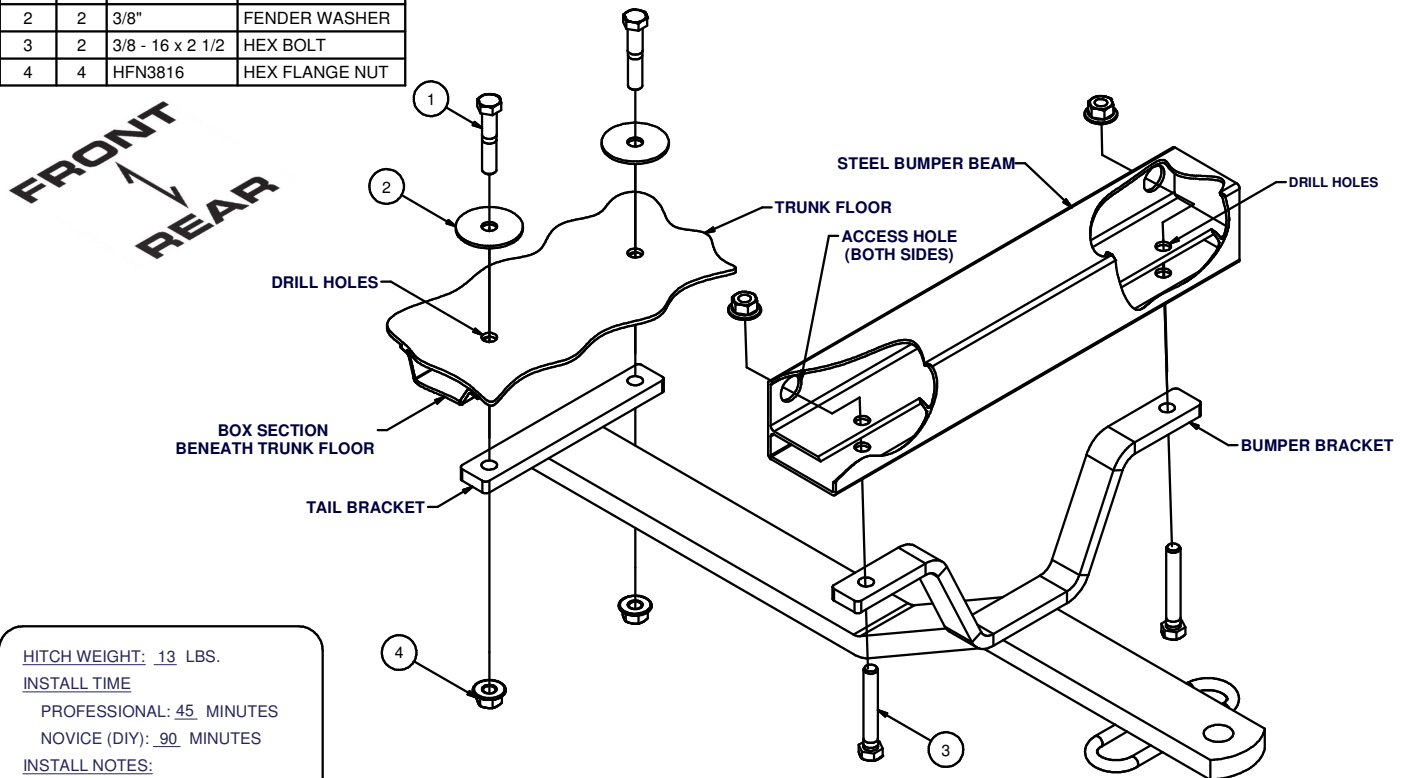
HITCH WEIGHT: 13 LBS.INSTALL TIMEPROFESSIONAL: 45 MINUTESNOVICE (DIY): 90 MINUTESINSTALL NOTES:

- CLEAR TRUNK
- DRILLING REQUIRED
- REMOVE BUMPER
- SILICONE SEAL HARDWARE

INSTALLATION STEPS

1. Temporarily remove all contents from the vehicle's trunk. Place the hitch on the vehicle centered and square so the hitch tail bracket fits on the 1" X 1" boxed section under the trunk floor. The bumper bracket should also make contact with the steel bumper under the fascia.
2. Using the hitch as a template, mark the steel bumper and boxed section beneath the trunk floor for the hitch bracket holes. Centerpunch and drill through (2) metal layers for 3/8" diameter mounting bolts on both bumper and boxed floor section.
3. Temporarily remove the rear bumper. The bumper unbolts inside the trunk at the rear body panel and at the rear of the wheel opening on both sides of the vehicle.
4. Mount the hitch to the bumper beam and trunk floor using fasteners as shown. Access for nuts in bumper is made through holes in front surface of the bumper. as shown Be sure to use fender washers inside of trunk.
5. Torque all 3/8" fasteners to 45 ft-lbs. **Be sure to not crush the box sections.**
6. Use silicone sealant to seal hardware installed through trunk floor.
7. Reinstall bumper and contents removed from trunk.

PERIODICALLY CHECK THIS RECEIVER HITCH TO ENSURE THAT ALL FASTENERS ARE TIGHT AND THAT ALL STRUCTURAL COMPONENTS ARE SOUND.

Curt Manufacturing Inc., warrants this product to be free of defects in material and/or workmanship at the time of retail purchase by the original purchaser. If the product is found to be defective, Curt Manufacturing Inc., may repair or replace the product, at their option, when the product is returned, prepaid, with proof of purchase. Alteration to, misuse of, or improper installation of this product voids the warranty. Curt Manufacturing Inc.'s liability is limited to repair or replacement of products found to be defective, and specifically excludes liability for incidental or consequential loss or damage.