



Safety glasses should be worn at all times while installing this product.

**YEARS: 2013-2018**  
**YEARS: 2014-2015**

**MAKE: HYUNDAI**  
**MAKE: KIA**

**MODEL: SANTA FE (2.0 / 2.4L 4 CYL ONLY)**  
**MODEL: SORENTO**

**STYLE: SUV**

**WARNING: NEVER EXCEED YOUR VEHICLE MANUFACTURER'S RECOMMENDED TOWING CAPACITY**

**WEIGHT CARRYING:**  
**TRAILER WEIGHT: 3500 LBS.**  
**TONGUE WEIGHT: 350 LBS.**

**WARNING:**  
**WE RECOMMEND THE USE OF 18050 STABILIZING STRAPS FOR ALL NON-TRAILER (WHEEL-LESS) LOADS. PLEASE SEE THE CURT CATALOG OR VISIT US ONLINE AT [WWW.CURTMFG.COM](http://WWW.CURTMFG.COM) FOR FURTHER INFORMATION.**

**PRO INSTALL TIME: 20 MIN.**  
**NOVICE INSTALL TIME: 40 MIN.**

*IF YOU ARE HESITANT TO UNDERTAKE THIS TASK ON YOUR OWN, CONTACT AN AUTHORIZED CURT INSTALLER FOR ADDITIONAL ASSISTANCE.*

**INSTALLATION REQUIRES:**

 <b>RATCHET</b>	 <b>TORQUE WRENCH</b>	 <b>6" SOCKET EXTENSION</b>
 <b>7/16" 3/4" 17mm SOCKET</b>	 <b>SCREW DRIVER</b>	 <b>SAFETY GLASSES</b>

**INSTALLATION TIPS:**

- BEFORE YOU BEGIN INSTALLATION, READ ALL INSTRUCTIONS THOROUGHLY.
- TO EASE INSTALLATION, 2 PEOPLE MAY BE REQUIRED.
- USING PROPER TOOLS WILL GREATLY IMPROVE THE QUALITY OF THE INSTALL AND REDUCE THE TIME REQUIRED.
- NEED HELP OR HAVE SOME QUESTIONS? CALL TECHNICAL SUPPORT AT 800.798.0813

**LEVEL OF DIFFICULTY: MODERATE**

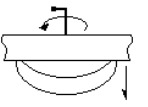
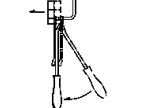
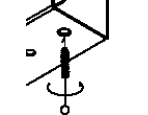
EASY	MODERATE	CHALLENGING
	- NO DRILLING REQUIRED	
	- LOWER SPARE & UNDER BODY PANELS	
	- LOWER EXHAUST	
	- CLEAN EXISTING WELDNUTS	

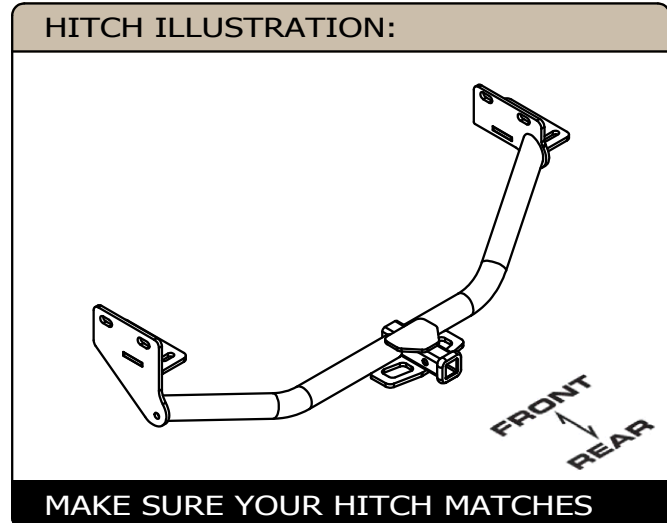

**PERIODICALLY CHECK THIS RECEIVER HITCH TO ENSURE ALL FASTENERS ARE TIGHT AND ALL STRUCTURAL COMPONENTS ARE SOUND**

CURT Manufacturing LLC. warrants this product to be free of defects in material and/or workmanship at the time of retail purchase by the original purchaser. If the product is found to be defective, Curt Manufacturing LLC. may repair or replace the product at their option, when the product is returned, prepaid, with proof of purchase. Alteration to, misuse of, or improper installation of this product voids the warranty. Curt Manufacturing LLC.'s liability is limited to repair or replacement of products found to be defective, and specifically excludes liability for incidental or consequential loss or damage.

For more information log onto [www.curtmfg.com](http://www.curtmfg.com), & for helpful towing tips log onto [www.hitchinfo.com](http://www.hitchinfo.com)

# INSTALLATION WALKTHROUGH:

Parts List			
ITEM	QTY	PART NUMBER	DESCRIPTION
1	4	1/2-13 x 4 1/2	CARRIAGE BOLT
2	4	HFN 1213, GR8	HEX FLANGE NUT
3	4	M10 - 1.25 x 25	HEX BOLT
4	4	3/8"	CONICAL TOOTHED WASHER
5	1	12113-SP	.188" SPACER PLATE

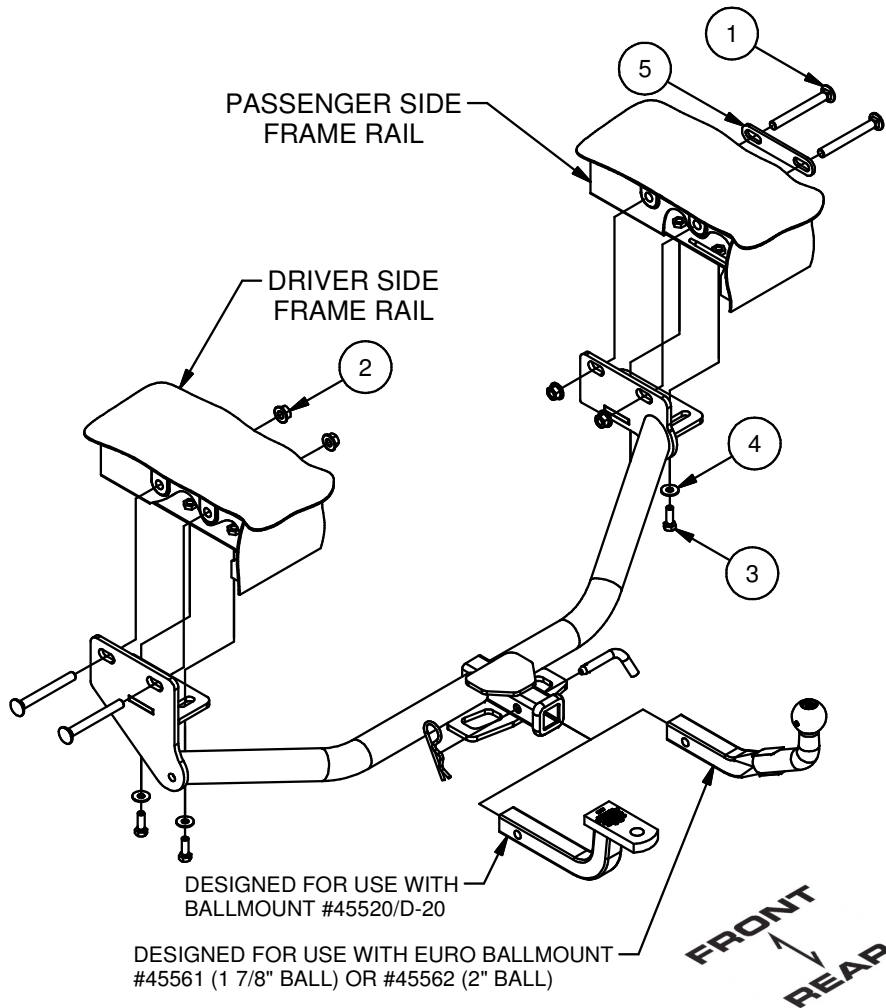

1. Lower and remove spare tire.

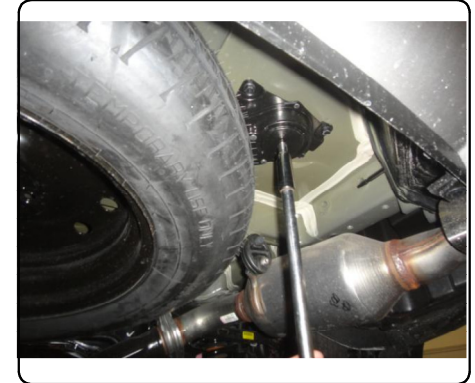
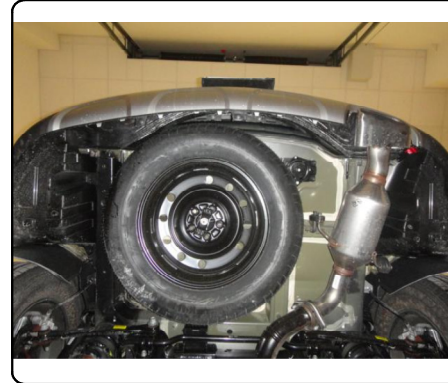

2. Lower exhaust by removing (3) rubber isolators.

### RUBBER ISOLATOR REMOVAL DIAGRAM

This technique can be used if an Exhaust Hanger Removal Pliers is not available.

Using a 5/8" open end wrench, slide the wrench up to the rubber isolator, cradling the hanger rod as shown. Next place the flat edge of a pry bar between the wrench and the hanger stop or hanger rod. Then simply rotate the pry bar toward the wrench to remove the rubber isolator.

Note: Using a spray lubricant or soapy water on the hanger rod and the rubber isolator helps removal.

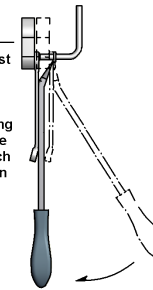

## INSTALLATION WALKTHROUGH:

3. Remove the plastic under body panel from the passenger side and the driver side frame rails. Remove (3) fascia screws from the passenger side and (4) from the driver side. Carefully pull down and set aside.

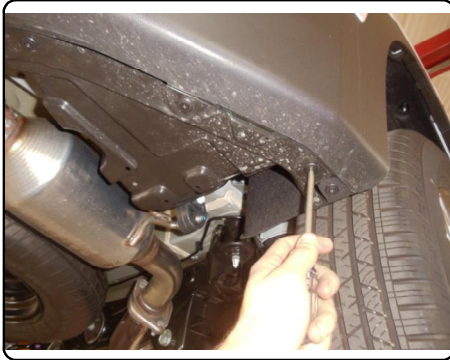

4. Raise hitch into position and secure to the existing weldnuts with M10-1.25 x 25mm bolts and 3/8" conical toothed washers. **Note:** The bumper locator pin may interfere with the hitch hardware. You may need to bend or trim it to allow hardware clearance.

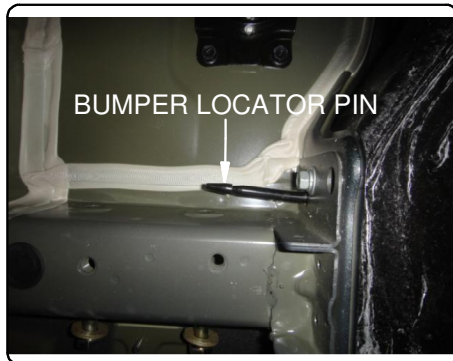

5. Insert 1/2-13 x 4 1/2" carriage bolts through the driver side plate and frame rail, secure using 1/2-13 flange nuts. Insert 1/2-13 x 4 1/2" carriage bolts through the 12113-SP spacer, in the passenger side frame rail and out the passenger side plate, secure using 1/2-13 flange nuts.



6. Torque all 1/2" hardware to 110 ft-lbs. Torque all 10mm hardware to 48 ft-lbs. Raise exhaust and spare tire back into position. Reinstall passenger side and driver side under body panels removed in Step (3).



12113

## KIA SORENTO &amp; HYUNDAI SANTA FE

7/20/2017

GROSS LOAD CAPACITY WHEN USED AS A WEIGHT CARRYING HITCH: 3500 LBS. TRAILER WEIGHT &amp; 350 LBS. TONGUE WEIGHT.

\*\*\*DO NOT EXCEED VEHICLE MANUFACTURER'S RECOMMENDED TOWING CAPACITY.\*\*\*

HAVING INSTALLATION QUESTIONS? CALL TECHNICAL SUPPORT AT 1-800-798-0813

Parts List				
ITEM	QTY	PART NUMBER	DESCRIPTION	
1	4	1/2-13 x 4 1/2	CARRIAGE BOLT	
2	4	HFN 1213, GR8	HEX FLANGE NUT	
3	4	M10 - 1.25 x 25	HEX BOLT	
4	4	3/8"	CONICAL TOOTHED WASHER	
5	1	12113-SP	.188" SPACER PLATE	

## CONICAL TOOTHED WASHER ORIENTATION DIAGRAM

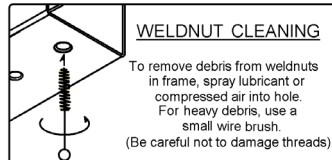
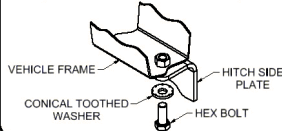

DRIVER SIDE  
FRAME RAIL

RUBBER ISOLATOR  
REMOVAL DIAGRAM

This technique can be used if an Exhaust Hanger Removal Pliers is not available.

Using a 5/8" open end wrench, slide the wrench up to the rubber isolator, cradling the hanger rod as shown. Next place the flat edge of a pry bar between the wrench and the hanger stop or hanger rod. Then simply rotate the pry bar toward the wrench to remove the rubber isolator.

Note: Using a spray lubricant or soapy water on the hanger rod and the rubber isolator helps removal.

BUMPER LOCATOR PIN  
(BOTH SIDES)

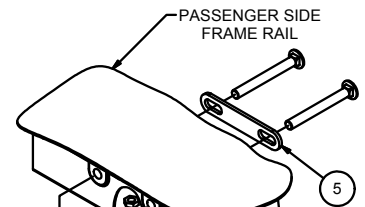

## TOOLS REQUIRED

RATCHET
TORQUE WRENCH
6" SOCKET EXTENSION
7/16" SOCKET
3/4" SOCKET
17mm SOCKET
SCREW DRIVER
SAFETY GLASSES

HITCH WEIGHT: 27 LBS.

## INSTALL TIME

PROFESSIONAL: 20 MINUTES

NOVICE (DIY): 40 MINUTES

## INSTALL NOTES:

- NO DRILL
- LOWER SPARE
- LOWER EXHAUST
- LOWER UNDER BODY PANELS

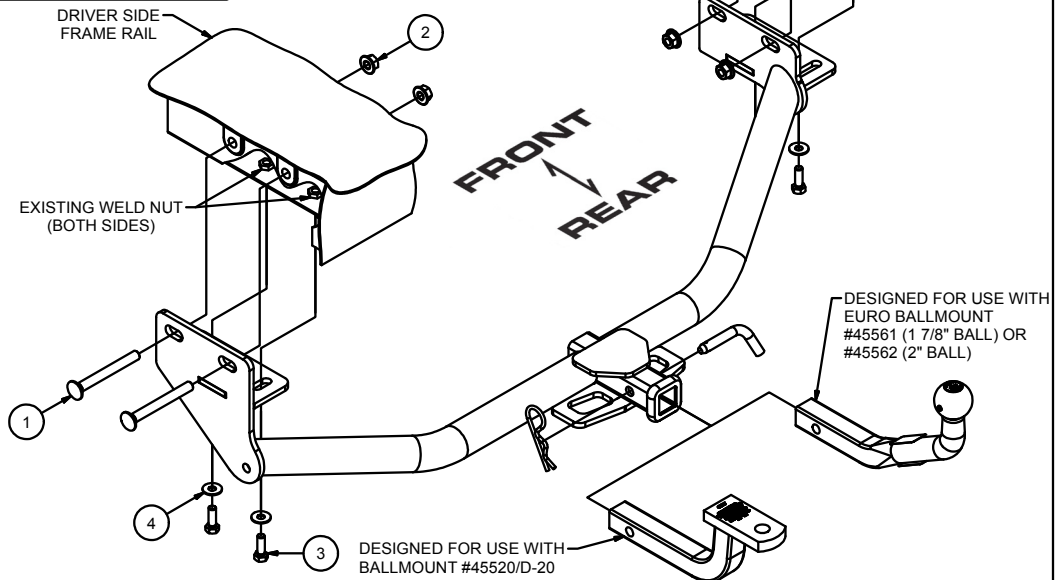

## INSTALLATION STEPS

1. Lower and remove spare tire.
2. Lower exhaust by removing (3) rubber isolators.
3. Remove the plastic under body panel from the passenger side and the driver side frame rails. Remove (3) fascia screws from the passenger side and (4) from the driver side. Carefully pull down and set aside.
4. Raise hitch into position and secure to the existing weldnuts with M10-1.25 x 25mm bolts and 3/8" conical toothed washers.
5. Insert 1/2-13 x 4 1/2" carriage bolts through the driver side plate and frame rail, secure using 1/2-13 flange nuts. Insert 1/2-13 x 4 1/2" carriage bolts through the 12113-SP spacer, in the passenger side frame rail and out the passenger side plate, secure using 1/2-13 flange nuts. **Note:** The bumper locator pin may interfere with the hitch hardware. You may need to bend or trim it to allow hardware clearance.
6. Torque all 1/2" hardware to 110 ft-lbs.  
Torque all 10mm hardware to 48 ft-lbs.
7. Raise exhaust and spare tire back into position. Reinstall passenger side and driver side under body panels removed in Step (3).

**PERIODICALLY CHECK THIS RECEIVER HITCH TO ENSURE THAT ALL FASTENERS ARE TIGHT AND THAT ALL STRUCTURAL COMPONENTS ARE SOUND.**

Curt Manufacturing LLC., warrants this product to be free of defects in material and/or workmanship at the time of retail purchase by the original purchaser. If the product is found to be defective, Curt Manufacturing LLC., may repair or replace the product, at their option, when the product is returned, prepaid, with proof of purchase. Alteration to, misuse of, or improper installation of this product voids the warranty. Curt Manufacturing LLC.'s liability is limited to repair or replacement of products found to be defective, and specifically excludes liability for incidental or consequential loss or damage.