

13064 / 757664

98-99 NISSAN FRONTIER ALL

10/3/2011

GROSS LOAD CAPACITY WHEN USED AS A WEIGHT CARRYING HITCH: 5,000 LBS. TRAILER WEIGHT & 500 LBS. TONGUE WEIGHT.
GROSS LOAD CAPACITY WHEN USED AS A WEIGHT DISTRIBUTION HITCH: 6,000 LBS. TRAILER WEIGHT & 600 LBS. TONGUE WEIGHT
DO NOT EXCEED VEHICLE MANUFACTURER'S RECOMMENDED TOWING CAPACITY.

Parts List			
ITEM	QTY	PART NUMBER	DESCRIPTION
1	4	CM-SP1	.250 x 1.50 x 2.00" SQUARE HOLE SPACER
2	4	HFN 1213	HEX FLANGE NUT
3	4	1/2-13 x 1 3/4	CARRIAGE BOLT

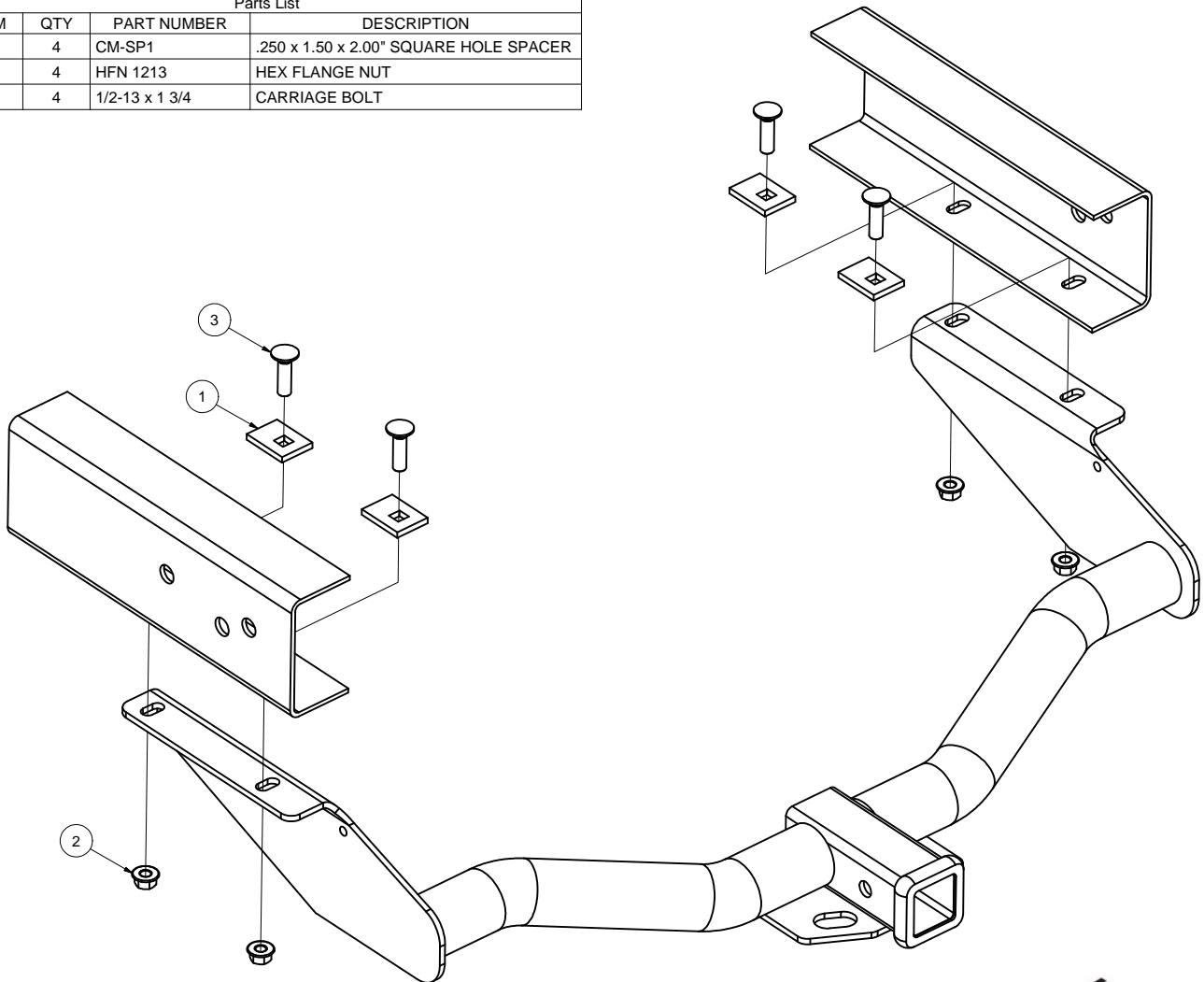

HITCH WEIGHT: 33 LBS.

INSTALL TIME: 30 MINUTES

INSTALL NOTES:
- NO DRILL REQ.

INSTALLATION STEPS

- 1) Raise the hitch into position at the end of the vehicle's frame rails.
- 2) Install fasteners as shown.
- 3) Torque all 1/2" fasteners to 75 lb-ft.

PERIODICALLY CHECK THIS RECEIVER HITCH TO ENSURE THAT ALL FASTENERS ARE TIGHT AND THAT ALL STRUCTURAL COMPONENTS ARE SOUND.

Curt Manufacturing Inc., warrants this product to be free of defects in material and/or workmanship at the time of retail purchase by the original purchaser. If the product is found to be defective, Curt Manufacturing Inc., may repair or replace the product, at their option, when the product is returned, prepaid, with proof of purchase. Alteration to, misuse of, or improper installation of this product voids the warranty. Curt Manufacturing Inc.'s liability is limited to repair or replacement of products found to be defective, and specifically excludes liability for incidental or consequential loss or damage.