

# INSTALLATION INSTRUCTIONS

RB10 SIDE STEPS

## TOYOTA TUNDRA DOUBLE CAB

2007 - 2015

# 63441580T

Parts list				
Item	QTY	Códe	Description	Max Torque
1	1 set	630087T	Side steps	
2	1 set	6344154AA	Front Bracket	
3	2 sets	6344154BA	Rear and rear center bracket	
4	1 set	634415CA	Front center bracket	
5	8 piece	6300874AA	U-bracket	
6	16 piece		5/16" x 1" hex head bolt black plate	11 Lb. Ft.
7	16 piece		5/16" flat washer black plate	
8	16 piece		5/16" lock washer black plate	
9	16 piece		M8" x 25mm hex heat bolt zinc plate	25 Lb. Ft.
10	16 piece		5/16" flat washer zinc plate	
11	16 piece		5/16" lock washer zinc plate	

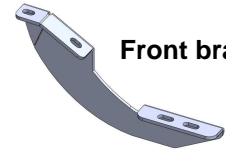

**Front bracket**

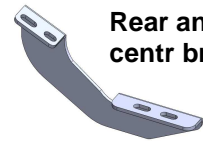

**Rear and rear center bracket**

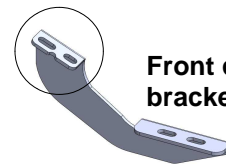

**Front center bracket**

### Required Tools (Not included)

- A. Ratchet w/ extension
- B. 12 mm socket
- C. 13 mm socket
- D. 15 mm socket

- 1.- Before beginning the installation, please read all directions carefully and verify that all necessary hardware is accounted for. If any parts are missing, stop the installation and contact your distributor immediately.
- 2.- To maintain and care this product keep it clean and do not use abrasive cleaners or polish waxes. We recommend to use only non-abrasive automotive wax such as pure carnauba to avoid scratches and rust.
- 3.- The approximate installation time is 45 min.

1. Before beginning the installation read all instructions carefully and verify that all hardware is accounted for. If there are any listed parts missing, please notify your distributor immediately.

2. See pictures 1, 2 Y 3 and locate the holes where the brackets are going to be installed.

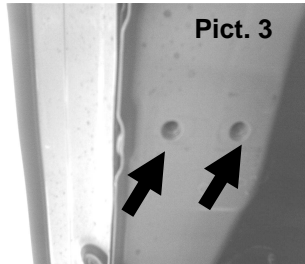
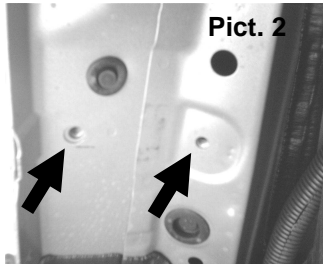
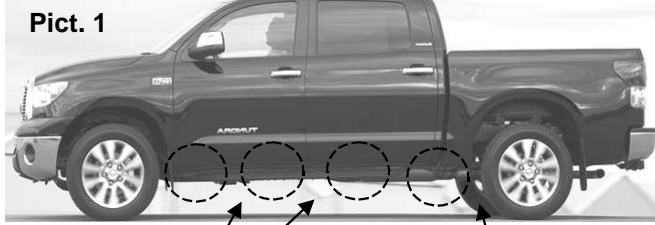

4. To install **middle and rear brackets** use two M8x25 hex head galvanized bolts, two flat washers and two lock washer for each bracket. See **Picture 4** and repeat it in the opposite side. Leave loose.

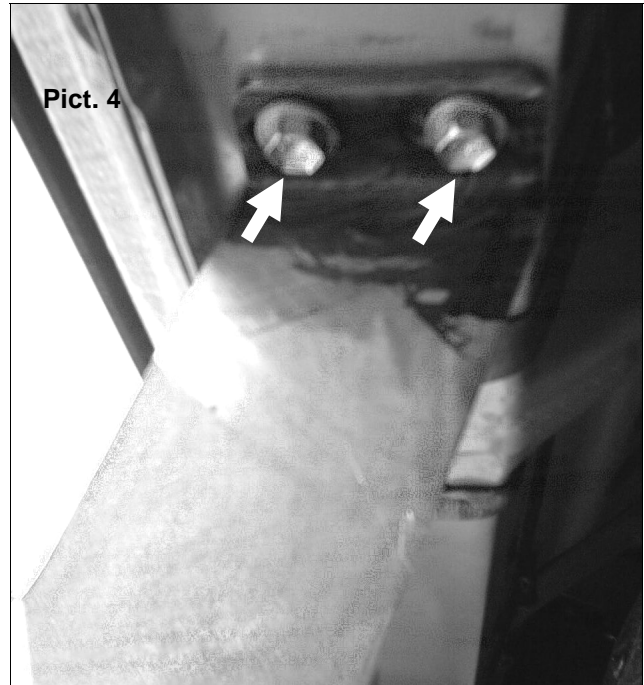

3. For the **Front bracket** install two M8x25 hex head galvanized bolts, two flat washers and two lock washers. See **Picture 5** and repeat it in the opposite side of the vehicle. Leave loose.

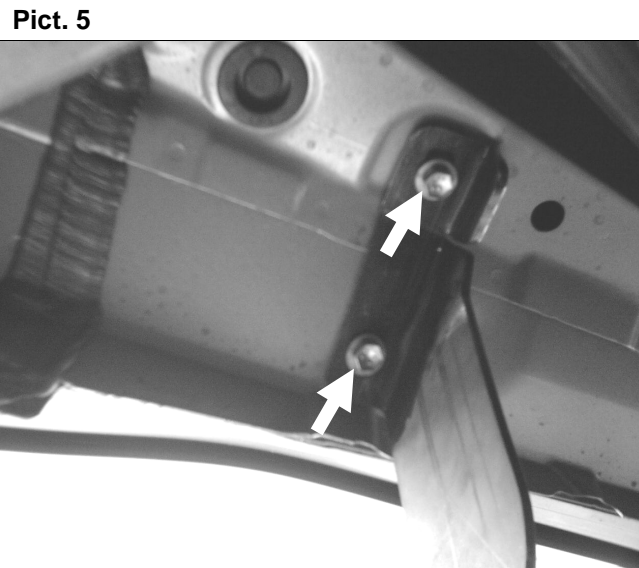

7. Place the sidebar on top of the mounting brackets. Position (3) of the U-brackets (included with the side step) inside the sidebar body, and align the U-brackets with the mounting brackets. Attach the side step and U-brackets to each mounting brackets using (2) 5/16" Hex head bolts, (2) 5/16" flat washers and (2) 5/16" lock washers. **ILLUSTRATION 1.**

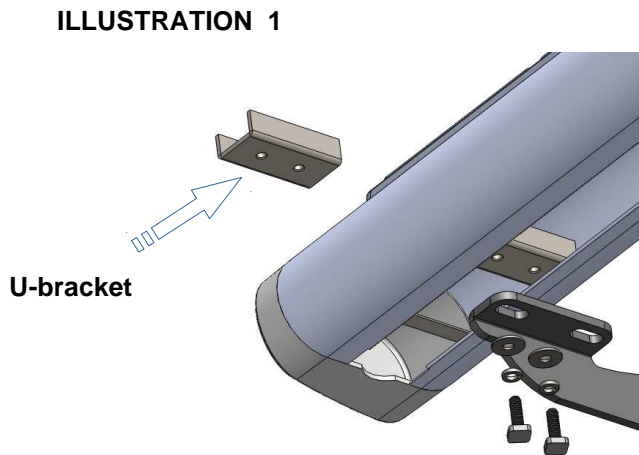

**Pict. 6**

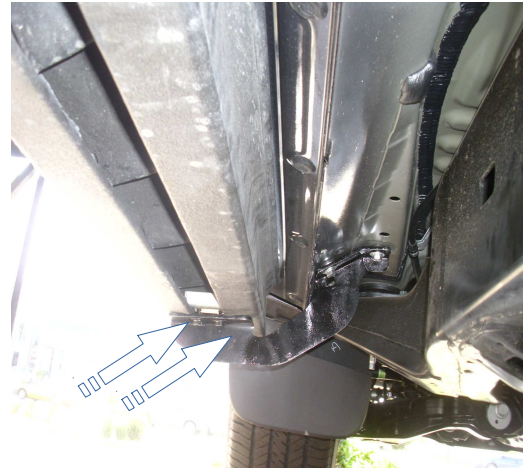

8. Align side bar RB10 and then tighten all bolts.
9. Periodically check your product because it may need a re-tighten of bolts.
10. Fill the warranty card and place it inside your vehicle's glove box.

**Pict. 7**

