



IMPORTANT WARRANTY & INSTALLATION INSTRUCTIONS ATTACHED

*Please Forward All Attached Information to Consumer
Warranty Not Valid Unless Returned to CORSA Exhaust*

We ask that you take a few moments to complete our warranty registration form:

TO ACTIVATE YOUR LIMITED LIFETIME WARRANTY GO TO:

CORSAPERFORMANCE.COM/WARRANTY



For Full-Color Installation Instructions, Please Visit:

CORSAPERFORMANCE.COM and Search by Part Number

Please be sure to review the enclosed instructions prior to beginning the installation process. If you have any questions about the enclosed parts, instructions or encounter a problem during Installation: **CALL CORSA PERFORMANCE TECHNICAL ASSISTANCE AT 800.486.0999**

Please take time to read and understand these installation instructions.

CORSA recommends that installation of this system be performed by a qualified service center or professional muffler installer who has the necessary equipment, tools and experienced personnel. However, if you decide to perform this install, the use of a hoist and an additional person will be required.

CAUTION: Never work on a hot exhaust system. Allow time for the vehicle to cool. Always wear eye protection when working under a vehicle.

Tools Needed: Safety glasses, 15mm socket with an extension, 5/16" allen wrench, torque wrench and needle nose pliers.

INSTALLATION NOTE:

Be sure to apply the provided anti-seize lubricant to all bolts, fasteners and clamps. A pouch is included with the hardware kit. Apply the supplied anti-seize lubricant to the threads **ONLY** of all TORCA band clamps. Failure to follow this procedure can cause the nuts to seize on clamps and potentially damage threads. **WARNING:** Be sure to thoroughly clean hands after use. Anti-seize lubricant will tarnish stainless steel parts.

All TORCA clamps should be tightened using a properly calibrated Torque Wrench. Using an air impact gun will damage the clamp and reduce its ability to effectively seal the joint. It may also cause the joint to separate thereby causing damage to your exhaust system and your vehicle.

Exhaust System Removal:

1. Using a 15mm socket, remove the two lower flange bolts (See Fig. A).
2. Using a 15mm socket, remove the two upper flange nuts (See Fig. B).
3. Remove the metal retaining clip, located above the passenger exhaust pipe, with needle nose pliers (See Fig. C).

NOTE: Be sure to save all retaining clips and rubber isolators removed from the vehicle. They will be used to install the CORSA Performance exhaust system in later steps.

4. The rubber isolator should now be free to slide off of both the exhaust system and the vehicle. Remove the rubber isolator (See Fig. D).
5. Support the exhaust system, and repeat steps 3 and 4 for the five other rubber isolators.
6. Remove the exhaust system.



FIG. A

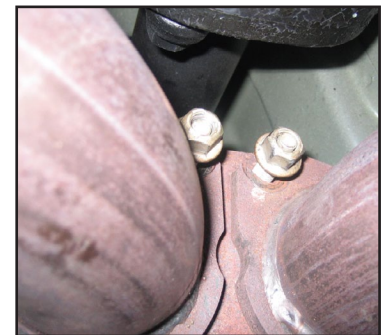

FIG. B



FIG. C



FIG. D

CORSA Performance Exhaust System Installation:

1. Remove all exhaust system components from the shipping cartons, including clamps. NOTE: There are four 2-1/2 inch clamps supplied for a SPORT system and six 2-1/2 inch clamps supplied for a TOURING system.

NOTE: Apply the anti-seize lubricant (supplied) to the threads ONLY of all the TORCA band clamps and flange bolts. Failure to follow this procedure can cause nuts to seize on clamps and potentially destroy threads.

After applying anti-seize lubricant, be sure to thoroughly clean hands as lubricant will tarnish stainless steel.

2. Locate x-pipe assembly, flange gaskets, nuts and bolts (See Fig. E and Fig. F). NOTE: Fig. E shows the TOURING x-pipe.
3. Place the flange gaskets over the flange after the catalytic converter, and using a 15mm socket with an extension and a 5/16" allen wrench install the x-pipe assembly. Snug the flange bolts; do not tighten completely (See Fig. G and Fig. H).

NOTE: Steps 4 and 5 for TOURING System ONLY.

4. Locate the TOURING mufflers and place a TORCA clamp on the inlet of each muffler (See Fig. I).
5. Slide TOURING muffler assembly inlets onto x-pipe pipe assembly outlets. Snug fit clamps (See Fig. J).
6. Locate the driver side rear pipe assembly and place a clamp on inlet end of assembly (See Fig. K).

For technical assistance, call (800) 486-0999.



FIG. E



FIG. F



FIG. G

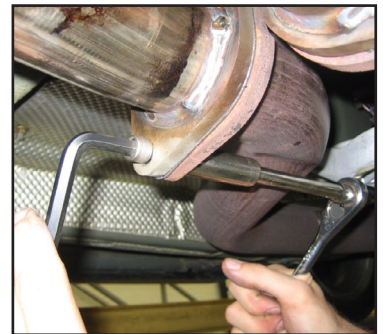

FIG. H



FIG. I



FIG. J



FIG. K

7. Slide one of the rubber isolators over the control shoulder of the driver side exhaust hanger on the rear pipe. Then slide the rubber isolator onto the exhaust hanger on the vehicle (See Fig. L).
8. Position the inlet of the rear pipe assembly over the outlet of the SPORT x-pipe assembly or TOURING muffler. Snug fit clamp.
9. Replace retaining clip (See Fig. M).
10. Repeat steps 6-9 for passenger side rear pipe assembly (See Fig. N).
11. Locate the driver side muffler assembly and place TORCA clamp on inlet end of assembly (See Fig. O).
12. Slide two rubber isolators onto muffler assembly. Then slide the rubber isolators onto the exhaust hangers on the vehicle (See Fig. P).
13. Slide muffler assembly inlet onto rear pipe assembly outlet. Snug fit clamp (See Fig. Q).
14. Replace retaining clips.
15. Repeat steps 11-14 for passenger side muffler assembly .
16. Visually inspect the exhaust system position, tip alignment, clamp orientation (See Fig. R) and exhaust pipe clearances. Make any necessary adjustments at the various slip joints. Check that X0-pipe is level and torque flange bolts to **40 ft.-lbs.** (See Fig. H)
17. When the exhaust system is in the desired location, tighten all TORCA clamps working from the front to rear of vehicle.

Torque Setting: 45 ft.-lbs.

18. It is strongly suggested that all clamps be checked and tightened after road testing the vehicle once the system has cooled.



FIG. O

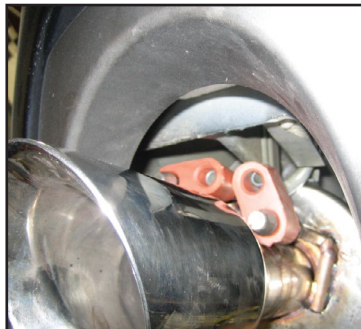

FIG. P



FIG. L



FIG. M



FIG. N



FIG. Q

CORSA Performance Exhaust System Adjustment Section:

There are adjustment points at every clamp location with the CORSA Performance Exhaust system for the 2005 Pontiac GTO system:

- Length adjustments can be made at every clamp joint.
- Rotational adjustments can be made at every clamp joint.

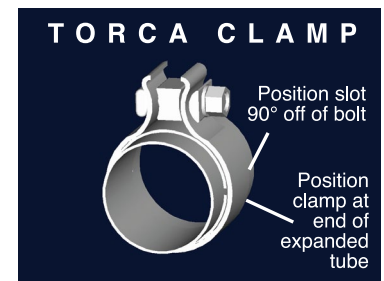
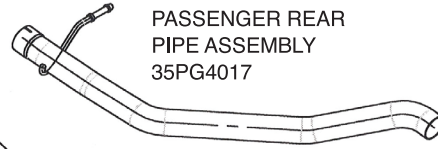
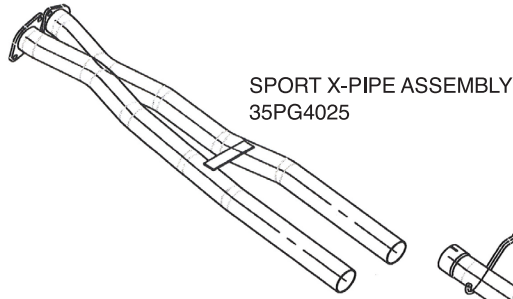
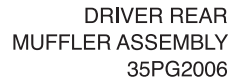
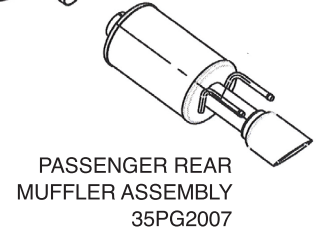
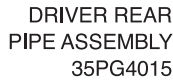
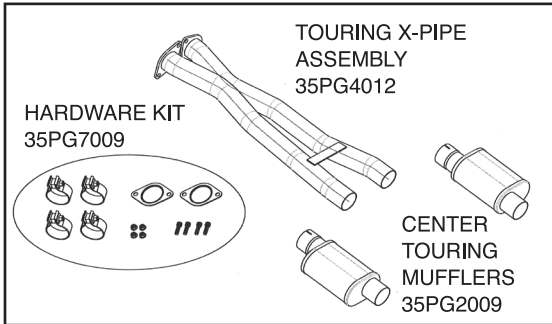

FIG. R

PN 14189
2005 Pontiac GTO
Sport Exhaust System
w/ 4.0" Pro-Series Tips



PN 14191
2005 Pontiac GTO
Sport to Touring Conversion Kit



PN 14190
2005 Pontiac GTO
Touring Exhaust System
w/ 4.0" Pro-Series Tips

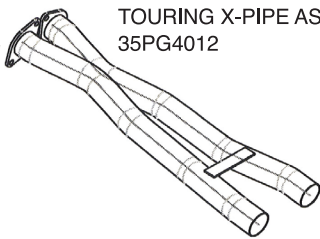

PN 14192
2005 Pontiac GTO
Touring to Sport Conversion Kit

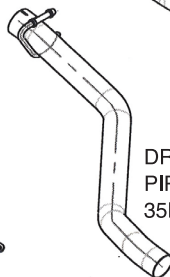
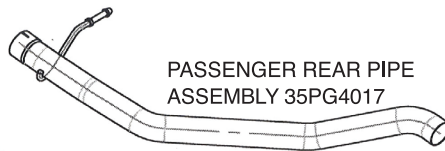
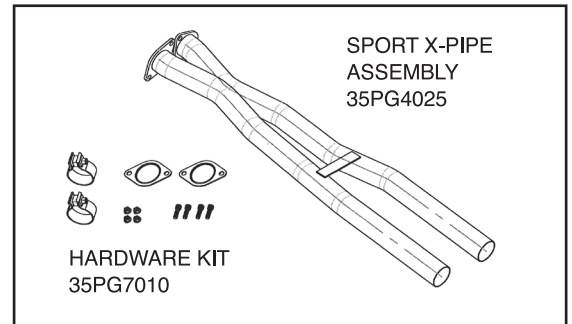

NOTE: During cold weather start-ups, you may experience an exhaust sound that is deeper and louder in tone than usual. This is temporary and will diminish to normal levels once your engine has reached its normal operating temperature.

NOTE: Immediately following the installation of your CORSA exhaust system, you may experience a trace of smoke after initial start-up. DO NOT be alarmed. The smoke is caused by the burning of a small amount of forming oil residue used in the manufacturing process.