



IMPORTANT WARRANTY & INSTALLATION INSTRUCTIONS ATTACHED

*Please Forward All Attached Information to Consumer
Warranty Not Valid Unless Returned to CORSA Exhaust*

We ask that you take a few moments to complete our warranty registration form:

TO ACTIVATE YOUR LIMITED LIFETIME WARRANTY GO TO:

CORSAPERFORMANCE.COM/WARRANTY



For Full-Color Installation Instructions, Please Visit:

CORSAPERFORMANCE.COM and Search by Part Number

Please be sure to review the enclosed instructions prior to beginning the installation process. If you have any questions about the enclosed parts, instructions or encounter a problem during Installation: **CALL CORSA PERFORMANCE TECHNICAL ASSISTANCE AT 800.486.0999**

Please take time to read and understand these installation instructions.

CORSA recommends that the installation of this system be performed by a qualified service center or professional muffler installer who has the necessary equipment, tools and experienced personnel. However, if you decide to perform this install, the use of a hoist and an additional person will be required.

CAUTION: Never work on a hot exhaust system. Allow time for the vehicle to cool. Always wear eye protection when working under a vehicle.

Recommended Tools:

- | | | |
|-------------------------|------------------|-------------------|
| • Soap & Water Solution | • Safety Glasses | • Grommet Pullers |
| • 12" Ratchet Extension | • 3/8" Ratchet | • 13mm Socket |
| | • 15mm Socket | • Torque Wrench |

Please confirm that all parts are present before beginning the factory exhaust system removal and CORSA Exhaust system installation.

Bill of Materials:

- 1 - Driver Side Rear Muffler Assembly (17CH2234 - SPORT) & (17CH2236 - XTREME)
- 2 - Passenger Side Rear Muffler Assembly (17CH2233 - SPORT) & (17CH2235 - XTREME)
- 3 - Tunnel Muffler Assembly (17CH2206)
- 4 - Driver Side Axle Pipe (17CH4290)
- 5 - Passenger Side Axle Pipe (17CH4291)
- 6 - X-Pipe Assembly (17CH4321)
- 7 - Hardware Kit (17CH7094)



Anti-Seize Lube Pouch (1)

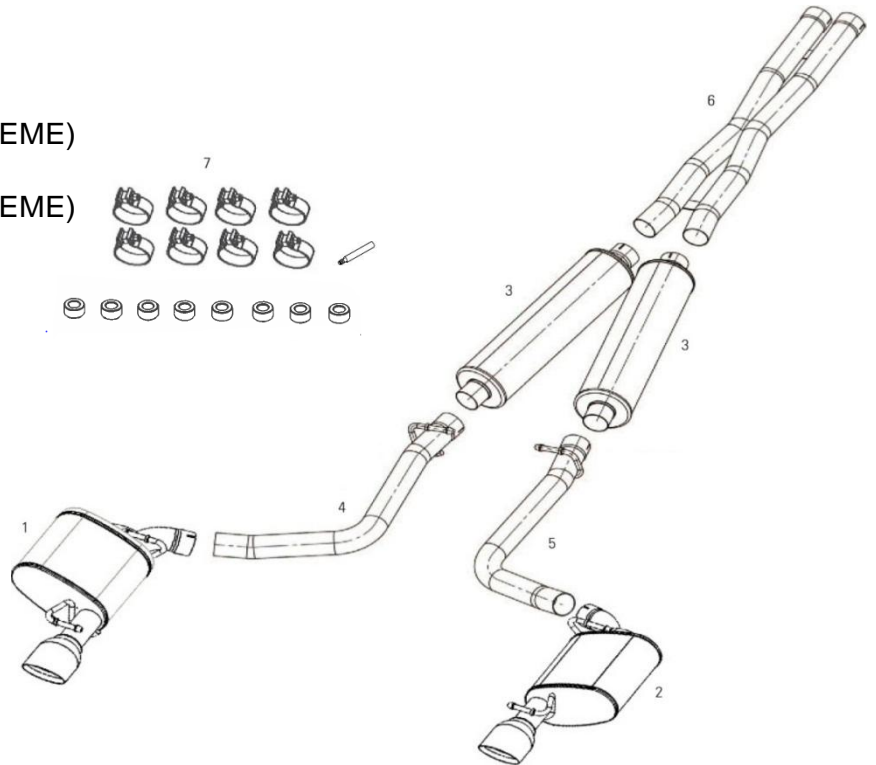

Factory Exhaust System Removal:

NOTE: Penetrating spay lubricant will assist removal.

1. Loosen the nuts and bolts at the flange connection on the driver side of the tunnel muffler using a 13mm wrench or socket. (See Fig A)
2. Remove the driver side factory hangers from the chassis using a 13mm socket and 12" extension attached to a 3/8" ratchet. (See Fig. B & C)
3. Remove the driver side axle pipe hanger from the grommet using grommet pullers or a similar device. Carefully remove the rear driver side section of the stock exhaust from the vehicle. (See Fig. D)
4. Remove the grommets and chassis hangers from the stock muffler and retain for CORSA exhaust install. (See Fig. E)
5. Loosen the tunnel brace bolts below the crossover pipe using a 13mm socket. Remove the tunnel braces from the chassis. (See Fig. F)
6. Remove the grounding clip from the passenger side rear muffler. (See Fig. G)
7. Repeat step 2 to remove the passenger side factory chassis hangers.
8. Using a 15mm socket, loosen the clamps at the front of the stock exhaust system. (See Fig. H)



FIG. A



FIG. B



FIG. C



FIG. D



FIG. E



FIG. F



FIG. G



FIG. H

9. Remove the passenger side axle pipe hanger from the rubber grommet. Carefully remove the remaining stock exhaust system from the vehicle. **(See Fig. I & J)**
10. Repeat step 4 for the passenger side. Remove the passenger side chassis hangers and grommets from stock mufflers and retain for CORSA exhaust install.



FIG. I



FIG. J

CORSA Exhaust Installation:

NOTE: Apply the anti-seize lubricant (supplied) to the threads ONLY of all the clamps and flange bolts. Failure to follow this procedure can cause nuts to seize on clamps and potentially destroy threads. After applying anti-seize lubricant, be sure to thoroughly clean hands as lubricant will tarnish stainless steel.

All clamps should be tightened using a properly calibrated Torque Wrench. Using an air impact gun will damage the clamp and reduce its ability to effectively seal the joint. It may also cause the joint to separate thereby causing damage to your exhaust system and your vehicle.

NOTE: Align all clamps so that the center of the clamp bolt is 90 degrees from the notch in the pipe **(See Fig. K)**

1. Remove all exhaust system components from shipping carton, including the eight supplied clamps.
2. Locate the CORSA X-pipe assembly, and two of the 2.75" clamps. **(See Fig. L)** Place the two clamps over the inlet side of the X-pipe, then slide the X-pipe over the retained stock pipes as shown, until it is around 1/2" from bottoming out. Make sure the X-pipe is oriented properly when installed. Next, verify the clamps are oriented as shown, and then snug the clamps using a 15mm socket and ratchet, leaving them loose enough for later adjustment. **(See Fig. M)**

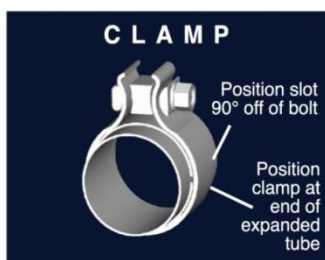

FIG. K



FIG. L



FIG. M

3. Locate one of the CORSA tunnel muffler assemblies and a 2.75" clamp. **(See Fig. N)** Place the clamp over the inlet side of the tunnel muffler, and then slide the muffler inlet onto the passenger side outlet of the X-pipe assembly as shown. Make sure the tunnel muffler is oriented properly when installed. **(See Fig. 1)** Next, verify the clamp is oriented as shown, then snug the clamp using a 15mm socket and ratchet leaving it loose enough for later adjustment. **(See Fig. O)**



FIG. N



FIG. 1

NOTE – IMPORTANT: Make sure that small drain holes of each tunnel muffler face down when Installed.

4. Repeat step 3 for the other tunnel muffler assembly, which gets installed onto the driver side outlet of the X-pipe assembly. Verify that the two tunnel mufflers are not touching each other, and have adequate clearance to the front edge of the cavity in the chassis.
5. Locate the driver side axle pipe assembly and another 2.75" clamp. **(See Fig. P)** Place the clamp over the inlet side of the pipe, then slide the pipe onto the end of the tunnel muffler assembly until it is around 1/4" from the muffler end cap. Next, insert the axle pipe hanger into the factory grommet. Rotate the axle pipe until the hanger is horizontal as it passes through the grommet, then snug the clamp using a 15mm socket and ratchet, leaving it loose enough for later adjustment. **(See Fig. Q)**
6. Repeat step 5 for the passenger side axle pipe assembly. This pipe should be around 1/4" from the muffler end cap when properly positioned. **(See Fig. R & S)** Both axle pipe hangers should be swung slightly forward of vertical, and be positioned directly across from each other, when the front to back position of both axle pipe assemblies are correct. **(See Fig. T)**
7. Replace the factory tunnel braces to their original locations. Torque the nuts to 18ft-lbs. using a shop stand **(See Fig. U)** or a spacer block create 1/2" clearance between the crossover pipe and the factory tunnel brace. The 1/2" gap will be maintained between the pipe and tunnel brace when tightening the clamps. If more clearance is needed, insert spacers provided in hardware kit between the vehicle floorboard and the brace.



FIG. O



FIG. P



FIG. Q



FIG. R



FIG. S



FIG. T

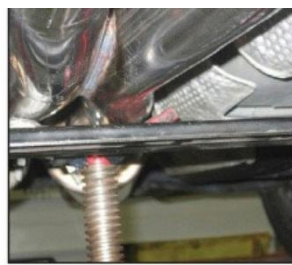

FIG. U

NOTE: The unbolted hanger assemblies from the removal process should now be installed onto the corresponding hangers on both of the CORSA rear mufflers by pushing the rubber grommets onto the hangers. Once again, a soapy water solution will aid in this installation process. **(See Fig. V & W)**

8. Locate the passenger side rear muffler assembly and another 2.75" clamp, as well as the retaining bolts for the factory hanger mounts. Place the clamp over the inlet side of the muffler, then slide the pipe onto the end of the axle pipe assembly. Align the hanger mounts with the mounting holes in the chassis, and secure with the 13mm bolts. **(See Fig. X & Y)** Using a torque wrench, torque the 13mm bolts to 18 ft-lbs.
9. Adjust the amount of overlap of the passenger side muffler inlet pipe onto the axle pipe until the exhaust tip looks properly positioned in the bumper opening, and then snug the clamp using a 15mm socket and ratchet, leaving it loose enough for later adjustment. **(See Fig. Z)** The minimum amount of pipe overlap should be just enough to prevent any gap from showing through at the base of the notch in the inlet pipe.
10. Insert the factory grounding clip onto the passenger side rear muffler hanger on the inlet side of the muffler.
11. Push the wire bundle, which sits just above the passenger side axle pipe outlet, up into the chassis to make sure that it does not sit too close to the axle pipe. **(See Fig. AA)**
12. Repeat steps 7 and 8 for the driver side rear muffler assembly. All rear muffler hangers should be swung noticeably forward of vertical when the front to back position of the rear muffler assemblies are correct. **(See Fig. BB)**
13. Visually inspect the exhaust system position, tip alignment, clamp orientation, and exhaust pipe clearance. Make any necessary adjustments at the slip joints.



FIG. V



FIG. W



FIG. X

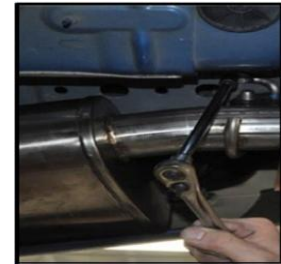

FIG. Y



FIG. Z



FIG. AA



FIG. BB

NOTE: The driver side axle pipe has to pass through the point of least clearance in the chassis, between the driver side rear suspension mount and the spare tire well. The pipe should have a finger width or so minimum clearance to the rear suspension mount, and should favor the front of this channel, as the pipes will grow rearward when heated during vehicle operation. (See Fig. CC) Adjusting the amount of pipe overlap at the X-pipe inlet clamping location will allow the entire system to be moved in the front to back direction, which is the easiest way to optimize the clearance at this location.



FIG. CC

14. With the tips held in the desired location, start at the front of the vehicle and tighten the nuts on the clamps. Torque nuts to 45 ft-lbs. Verify clearances to underbody components after tightening.
15. It is **STRONGLY SUGGESTED** that all clamps be checked and re-tightened, if necessary, to the recommended torque after initial road testing of the vehicle, as thermal cycling has occurred on the system. Please wait until system has fully cooled to perform step.

NOTE: During cold weather start-ups you may experience an exhaust sound that is deeper and louder in ton than usual. This is temporary and will diminish to normal levels once your engine has reached its normal operation temperature.

NOTE: Immediately following the installation of your exhaust system, you may experience a trace of smoke after initial start-up. **DO NOT** be alarmed. The smoke is caused by the burning of a small amount of forming oil residue used in the manufacturing process.

Back Pressure Sensor Restrictor Pill Installation

1. Locate the exhaust back pressure sensor line on the passenger side of the exhaust system. It is on the stock piping upstream of the tunnel muffler.(**Fig. DD**)
2. Using pliers, release the clamp from the tubing and carefully pull the tubing off of the sensor's barb.(**Fig. EE and FF**) Leave the clamp on the stock tubing.
3. Insert the white barb fitting into the stock tubing. Using the pliers again, slide the clamp onto the joint to secure the stock tubing onto the barb.(**Fig. GG**)
4. Slide the new tubing over the back pressure sensor's barb. The fit will be tighter than the stock tubing so no clamp should be needed.

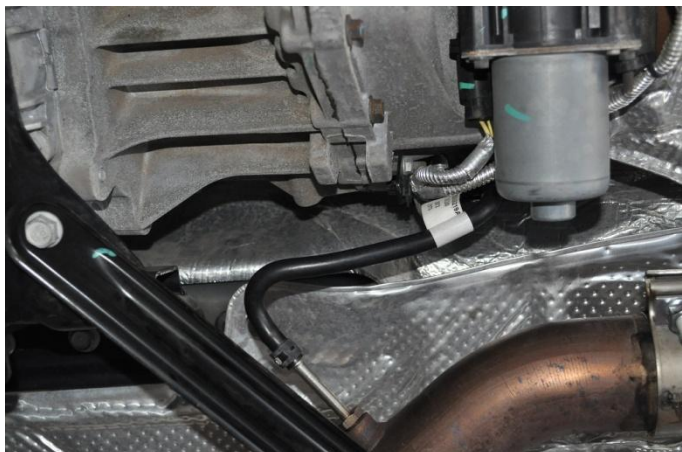

Fig. DD



Fig. EE

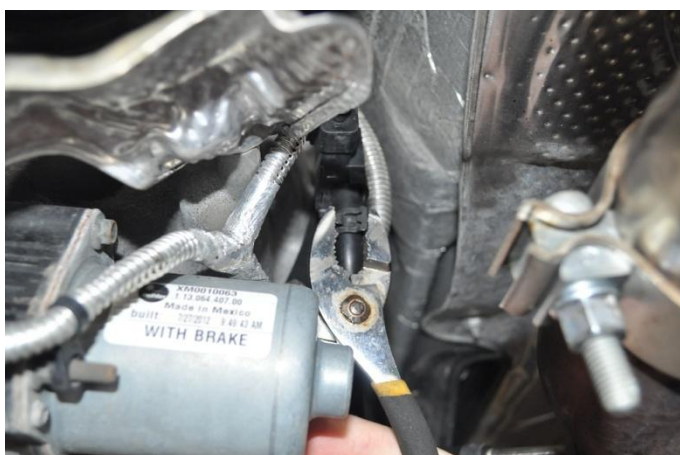

Fig. FF

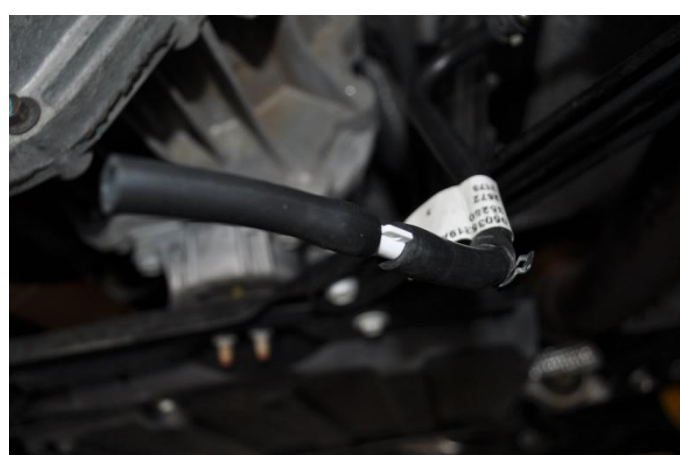

Fig. GG