

Please take time to read and understand these installation instructions.

CORSA recommends that installation of this system be performed by a qualified service center or professional muffler installer who has the necessary equipment, tools and experienced personnel. However, if you decide to perform this install, the use of a hoist and an additional person will be required.

CAUTION: Never work on a hot exhaust system. Allow time for the vehicle to cool. Always wear eye protection when working under a vehicle.



Please confirm that all parts are present before beginning the factory exhaust system removal and CORSA exhaust system installation.

Bill of Materials:

- Driver Muffler Assembly (15CV2030) Touring / (15CV2044) Sport
- Passenger Muffler Assembly (15CV2029) Touring / (15CV2043) Sport
- Hardware Kit (18VP7031)
- Packet of Anti-Seize

Recommended Tools:

- Safety glasses
- 15mm socket and ratchet
- Saw or chain-style pipe cutter
- Torque wrench
- File or sanding device for deburring
- Grommet pullers
- Soap and water solution

Passenger Muffler Assembly
 (15CV2029) Touring
 (15CV2043) Sport

Driver Muffler Assembly
 (15CV2030) Touring
 (15CV2044) Sport

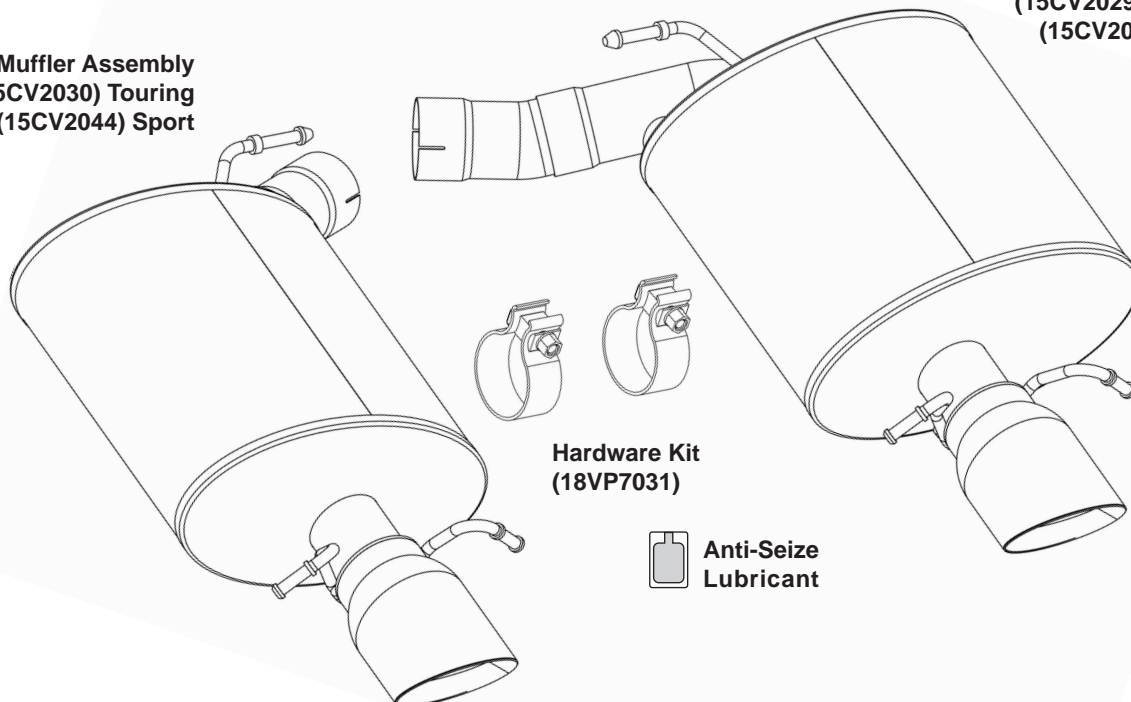

Hardware Kit
 (18VP7031)

Anti-Seize
 Lubricant

Removal Of Stock Exhaust:

1. Measure from the inlet weld of the rear muffler and mark the passenger side pipe at 6.5 inches. Repeat on the driver side. **(See Fig. A)**
2. Using a saw or chain style pipe cutter, cut each pipe at the marks. **(See Fig. B)** Deburr the cut edge of the retained factory pipe, using a file or sanding device, to aid in the installation process.
3. Using grommet pullers or a similar device, remove the passenger side front hanger from the rubber isolator. **(See Fig. C)** Use caution as the stock muffler assembly may drop down on the front side when it is only being retained by the two rear hangers.

NOTE: The use of a soapy water solution may aid in the removal and later installation of the hangers in the rubber isolators.

4. Using grommet pullers or a similar device, remove the passenger side inner and outer rear hangers from the rubber isolators. **(See Fig. D & E)** This will free the stock passenger side muffler assembly from the vehicle. **(See Fig. F)**
5. Repeat steps 3 & 4 for the driver side.
6. Removal is complete. Installation of your CORSA Performance exhaust system can now begin. See Page 3.

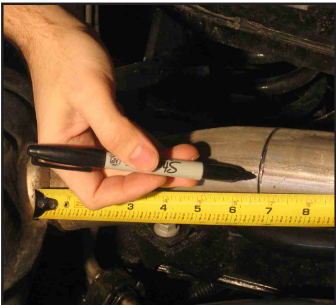

FIG. A

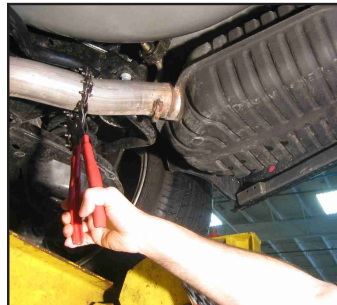

FIG. B

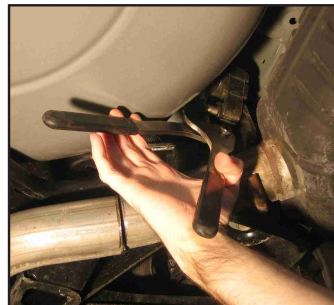

FIG. C

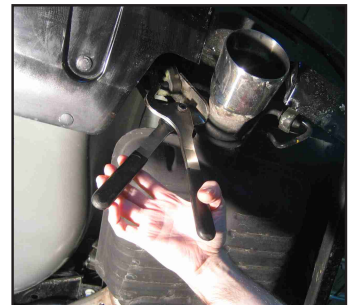

FIG. D

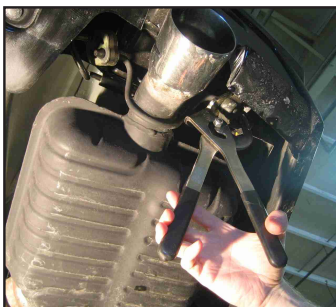

FIG. E

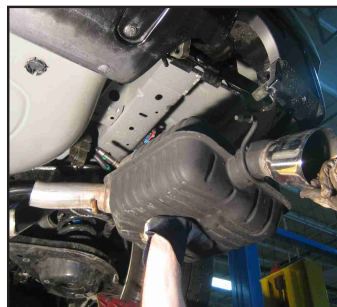

FIG. F

If at any time you need technical assistance, call (800) 486-0999 to speak with a CORSA Representative.

Installation of CORSA Exhaust System:

NOTE: Apply the anti-seize lubricant (supplied) to the threads **ONLY** of all the clamps and flange bolts. Failure to follow this procedure can cause nuts to seize on clamps and potentially destroy threads. After applying anti-seize lubricant, be sure to thoroughly clean hands as lubricant will tarnish stainless steel. All clamps should be tightened using a properly calibrated Torque Wrench. Using an air impact gun will damage the clamp and reduce its ability to effectively seal the joint. It may also cause the joint to separate thereby causing damage to your exhaust system and your vehicle.

NOTE: Align all clamps so that the center of the clamp bolt is 90 degrees from the notch in the pipe (See Fig. G)

1. Remove all exhaust system components from the shipping carton, including the two clamps.
2. Locate the passenger side muffler assembly, and one pipe clamp. Properly align the clamp (see above note) on the muffler inlet and slide the muffler inlet over the passenger side factory pipe. **(See Fig. H)** Make sure the muffler inlet is over the stock pipe deep enough that no gap shows through in the pipe notch.
3. Insert all of the hangers into the corresponding rubber isolators, starting with the two rear hangers, **(See Fig I & J)** and then moving to the front muffler hanger. **(See Fig. K)** Once again, a soapy water solution will aid in the installation process.
4. Adjust the amount of overlap of the muffler inlet pipe onto the passenger side factory pipe until the exhaust tip looks properly positioned in the bumper opening, **(See Fig. L)** and then snug tighten the clamp on the muffler inlet pipe using a 15mm socket and ratchet. **(See Fig. M)**
5. Repeat steps 2-4 for the driver side.

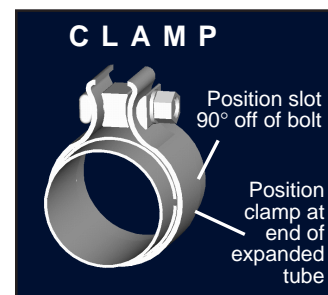

FIG. G



FIG. H

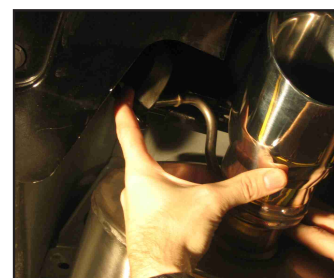

FIG. I

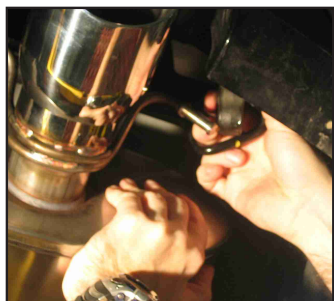

FIG. J

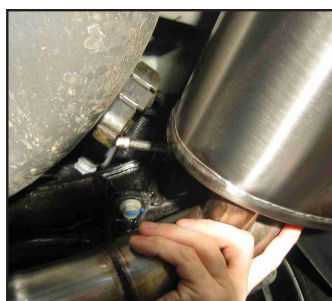

FIG. K

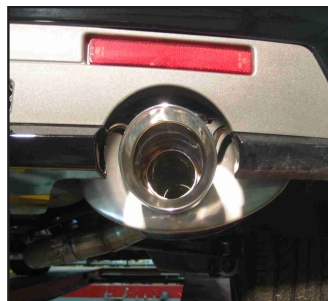

FIG. L



FIG. M

6. Visually inspect the exhaust system position, tip alignment, clamp orientation, and exhaust pipe clearance. Make any necessary adjustments at the slip joints.
7. When the exhaust system is in the desired location, **(See Fig. N)** tighten the nuts on the clamps. **Torque nuts to 45 ft-lbs (61 N-m).**



FIG. N

8. It is **STRONGLY SUGGESTED** that all clamps be checked and re-tightened (if necessary) to the recommended torque after initial road testing of the vehicle, as thermal cycling has occurred on the system. Please wait until system has fully cooled to conduct this process.

NOTE: During cold weather start-ups, you may experience an exhaust sound that is deeper and louder in tone than usual. This is temporary and will diminish to normal levels once your engine has reached its normal operating temperature.

NOTE: Immediately following the installation of your CORSA exhaust system, you may experience a trace of smoke after initial start-up. DO NOT be alarmed. The smoke is caused by the burning of a small amount of forming oil residue used in the manufacturing process.