



INSTALLATION INSTRUCTIONS

ATOMIC-COOL TRANSMISSION COOLER KIT

PART # 15950

Please read these instructions completely before starting the installation.

KIT CONTENTS

QTY. DESCRIPTION	QTY. DESCRIPTION
1 Oil Cooler Assembly	1 In-line Thermostat Fitting
2 -8AN x 5/8" Male Adapter	4 Hose Clamp
1 -8AN Male x 1/2" Barb Fitting	4 1/4"-20 x 1" Hex Bolt
3 -8AN Female x 1/2" Barb Fitting	8 1/4" Washer
10ft 1/2" OEM Spec Hose	4 1/4"-20 Lock Nut
2 1/2" Compression Fitting	4 6" Zip Ties
2 1/2" NPT Female x 1/2" Barb Fitting	1 #10 Blue Ring Terminal
1 Thermostat Switch	2 Blue Female Connectors
	1 Blue Wire Tap Connector

TOOLS NEEDED

Standard Screw Driver	7/8" Open End Wrench
or 5/16" Nut Driver	1 1/8" Open End Wrench
7/16" Socket & Ratchet	Teflon Tape
13/16" Open End Wrench	Razor Knife
15/16" Open End Wrench	Marker
3/4" Open End Wrench	Tubing Cutter

IMPORTANT

Always use backup wrenches when tightening fittings. The AN fittings supplied in this kit do not require any thread sealant.

COOLER LOCATION

The purpose of a remote mount cooler is to be able to mount the cooler away from the front of the vehicle therefore not blocking airflow to the radiator/condenser. This cooler can be mounted anywhere space permits. Always keep in mind that the cooler still needs access to airflow to perform at its peak.

COOLER INSTALLATION

1. Identify the two -8AN x 5/8" Male Adapters.
 2. Install the fittings onto the cooler with the o-ring side toward the cooler.
- Note:** Thread sealant is not necessary on o-ring fittings.
3. Using a 1 1/8" Open End Wrench, tighten fittings.
 4. Hold the Oil Cooler Assembly in the desired location.
 5. Using a marker, mark the four hole locations.
 6. Using a drill and 9/32" drill bit, drill the four mounting holes.
 7. Identify the 1/4"-20 x 1" Bolts, 1/4" Washers & 1/4" Lock Nuts supplied and attach the Oil Cooler Assembly.

Diagram #1

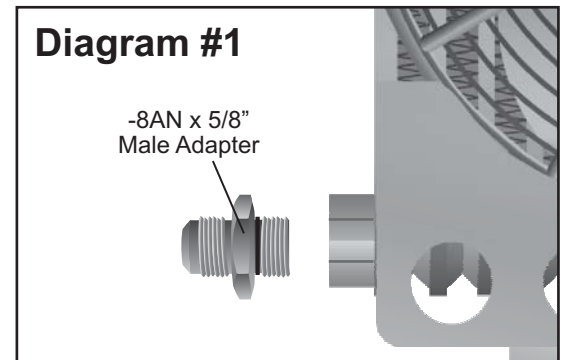

IN-LINE THERMOSTAT INSTALLATION

Mounting Location

The recommended location for the In-line Thermostat Fitting is on the INLET side of the oil cooler, so the oil line that provides the cooler fluid from the transmission.

Warning: Always use two wrenches when tightening the In-line Thermostat Fitting to the oil cooler; failure to use a back up wrench could cause damage to the cooler core.

There are two options for installing the In-Line Thermostat.

1. Cooler inlet installation (See Diagram #2)

The In-line Thermostat Fitting is provided with a -8AN male and female threads.

- a) Attach the In-line Thermostat Fitting onto the INLET fitting on the oil cooler.
- b) Using Loctite or suitable sealant, carefully HAND TIGHTEN ONLY the Thermostat Switch clockwise onto the In-line Thermostat Fitting.

Warning: Do not use a wrench or damage to the Thermostat Switch could occur.

2. Hose installation (See Diagram #3)

The kit provides two brass fittings that are only used with this option. They are designed to adapt the AN fittings to hose barsbs.

- a) Using the -8AN Male x 1/2" Barb Fitting provided, attach the fitting to the female side of the In-line Thermostat Fitting.
- b) Using the -8AN Female x 1/2" Hose Barb Fitting provided, attach the fitting to the Male Adapter now installed on the cooler.
- c) Using the OEM Spec Hose and Hose Clamps provided, cut the hose to the desired length and attach one end of the hose to the oil cooler inlet and the other to the In-line Thermostat.
- d) Using Loctite or suitable sealant, carefully HAND TIGHTEN ONLY the Thermostat Switch clockwise onto the In-line Thermostat Fitting.

Warning: Do not use a wrench or damage to the Thermostat Switch could occur.

(Continues on Page 2)

Diagram #2

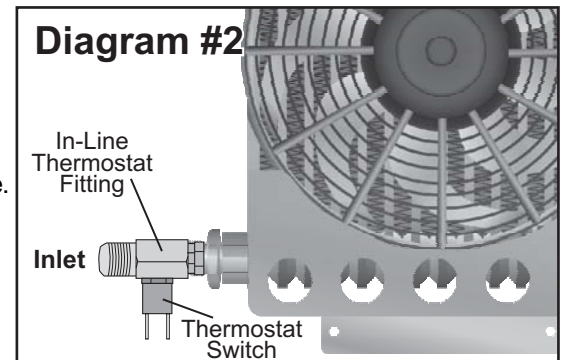
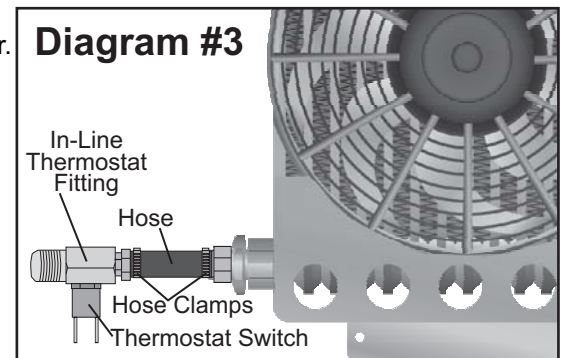

Diagram #3



IN-LINE THERMOSTAT SWITCH WIRING (See Diagram #4)

Specifications- Electric Fan rating: 4.8 Amps

Thermostat Switch: Maximum of 15 continuous Amps

1. Using the supplied #10 Blue Ring Terminal, attach the Negative (-) wire on the Electric Fan to a good chassis Ground (-).
2. Using the Blue Female Connector supplied, attach the Positive (+) wire on the Electric Fan to EITHER terminal on the Thermostat Switch.
3. Using the Blue Female Connector and the Blue Wire Tap Connector supplied, attach the remaining Thermostat Switch terminal to a 12V Positive (+) Switched Ignition source.

Diagram #4

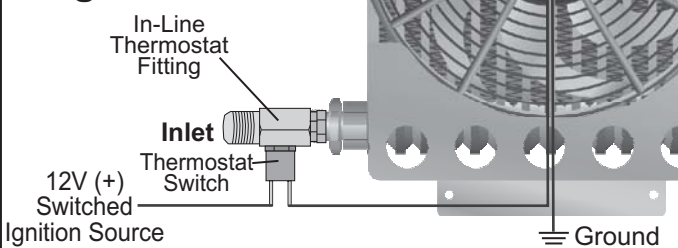

Warning: If this wire is connected directly to the vehicles battery the Electric Fan will run after the vehicle has been shut off.

CONNECTING COOLER TO TRANSMISSION

IMPORTANT: This kit includes two fitting options to attach the cooler to the transmission cooler lines. This will allow hose to be connected to the transmission cooler line without having to flare factory line.

1/2" Compression Fittings - Designed to install onto all 1/2" Diameter transmission lines.

PRIMARY COOLING

Transmission (See Diagram #5 & 6)

1. Disconnect the factory transmission lines and plug the factory transmission line fittings on the radiator. (If Applicable)
2. Using a tubing cutter, cut the transmission lines to length in the desired location.
3. Determine which diameter transmission lines are on the vehicle. Using a tape measure, measure the outside of the transmission line from one side to the other.
4. For 1/2" lines, identify the two 1/2" Compression Fittings and two 1/2" Female NPT x 1/2" Barb Fittings.
5. Using Teflon Tape of suitable sealant, attach the 1/2" Female NPT x 1/2" Barb Fittings onto the Compression Fittings & tighten.
6. Install the Compression Fittings onto the cooler lines and tighten. (See Diagram #5)

Cooler (See Diagram #6)

7. Identify the two -6AN Female x 3/8" Barb Fittings.
8. Install the fittings onto the cooler/In-line Thermostat Fitting and tighten.

Note: No thread sealant is necessary for AN fittings.

9. Using the Hose and Hose Clamps supplied, slide one Hose Clamp over each end of the Hose.
10. Using a dab of oil, lubricate each end of the hose and install onto the cooler fittings forming a loop with the hose.
11. Secure in place using the Hose Clamps.

Routing Hoses (See Diagram #6)

12. Using the Zip Ties supplied, carefully route the looped hose now attached to the cooler toward the Compression Fittings.

Warning: When routing hoses, be sure to keep all hoses away from sharp edges, moving parts and hot engine components. Hoses should be routed carefully and should not be bent in less than a 3" radius.

Important: A kinked hose will restrict flow and could cause transmission failure.

13. Using a supplied Hose Clamp, cut hose to desired length & attach the Inlet hose on the cooler to the feed line on the transmission.
14. Using a supplied Hose Clamp, cut hose to desired length and attach the remaining hose on the cooler to the return line on the transmission.

Diagram #5

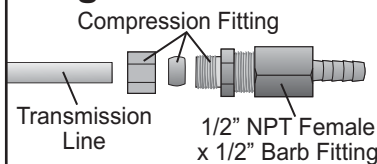

Diagram #6 Primary Cooling

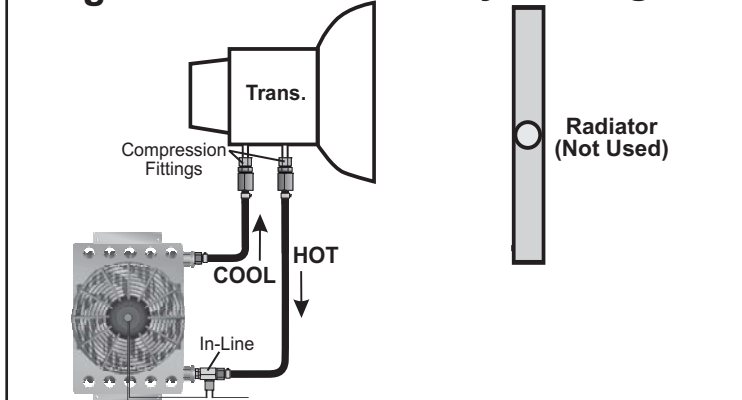
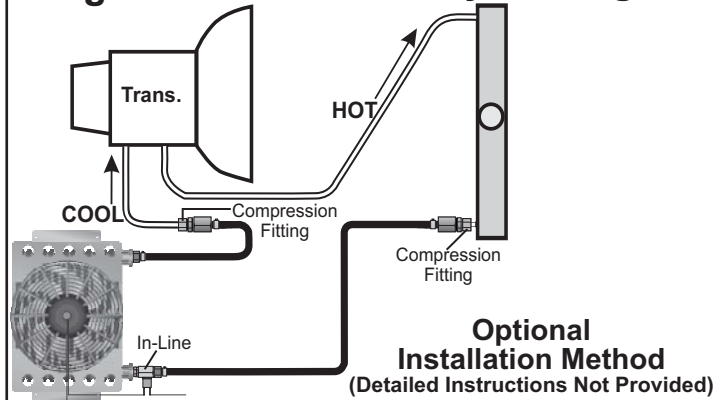

Diagram #7 Secondary Cooling



SYSTEM CHECK

1. Start the vehicle and quickly check all connections for leaks.
2. With the vehicle in neutral, check the transmission fluid level. Add fluid as needed.
3. Drive vehicle making sure transmission is warm, then recheck fluid level.

Warning: Installation of accessories should only be undertaken by those with mechanical knowledge and are familiar with working on vehicles. Always use eye protection (goggles, safety glasses or shield). Park the vehicle in a well lit area, on level ground and apply the parking brake. Only work on a cold vehicle that has been sitting overnight, failure to do so will result in severe burns and injury. Before starting the vehicle, make sure no tools or any other items are left under hood that could interfere with or be drawn into moving parts of the engine. Failure to follow instructions can lead to severe damage and personal injury.