

# TINY MONSTER<sup>®</sup>

**XTREME BULB**  
SERIES

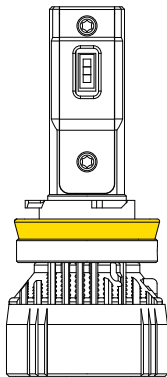

## OWNER'S MANUAL



2X LED BULBS



COOL WHITE



PLUG & PLAY



SUPER BRIGHT

# THANK YOU!

Thank you for purchasing ARC Lighting products. Read this instruction manual thoroughly for proper use of the product. After completing your installation, please keep this manual for future reference.

For additional product information and resources please visit [www.arc.lighting/user-guide](http://www.arc.lighting/user-guide)

## PARTS

**2X LED BULBS**

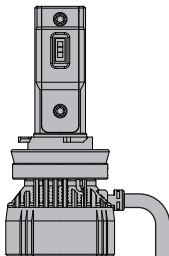

**1X HEX KEY**



**2X SET  
SCREWS**



(9005, 9006, 9012,  
H11, H10 BULBS ONLY)



**2X LED DRIVERS**

# NOTES

- This product is a 12V bulb for vehicles. Do not install it in 24V or 48V vehicles.
- Handle the bulb only at its cool condition. Make sure not to touch the base of the LED bulb when it is turned on. The LED bulb can get very hot when operating.
- Be careful not to apply excessive force to the light emitting part. Prevent any type of oil or dirt from adhering to the product.
- When operating, the micro-cooling fan will produce noise. This is normal.
- Do not look directly at the operating lamp as it is extremely high intensity.

## STEP 1

Access the rear of the factory assembly for the bulb you are replacing. Locate and remove your factory bulb. Refer to the vehicle's installation manual for proper instructions to access the correct bulb.

Note: Some housings have rubber or plastic dust caps. Remove the dust cap to access the stock bulb.

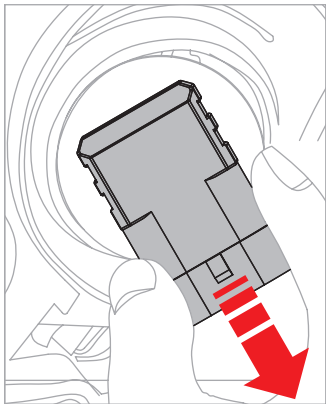

## STEP 2

Install the bulbs into the assembly.  
For most bulb types, use the same install steps as replacing the stock bulbs.

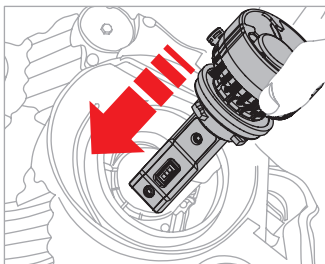

For bulbs H4/H7/9004/9007, the collar on the LED bulb needs to be removed before installation. To do so, push the bulb base inward and turn the collar counter clockwise 180°. Secure the collar inside the headlight socket or mounting adapter. Finally, insert the bulb back inside the collar and turn the bulb clockwise to lock. Note: The bulb shaft has two small tabs of different sizes that match the notches on the collar. It can only be inserted one way.

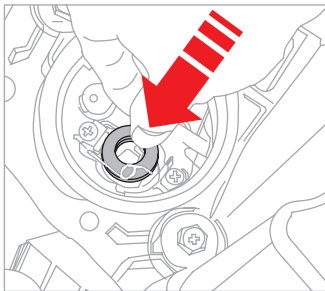
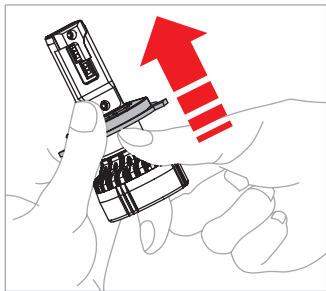

## STEP 3

Check to make sure the position of the diodes (LED chips) are in a horizontal side to side orientation. (See bulb orientation instructions).  
Note: If the bulb is tilted at an angle when installed on your vehicle, correct it by adjusting the rotatable collar. (See collar adjustment instructions).

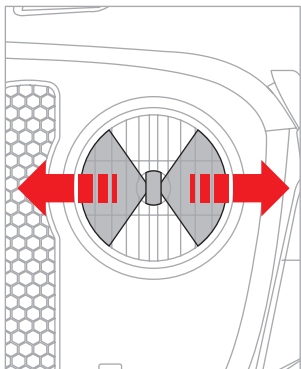

## STEP 4

Insert the connectors of the LED bulb into the factory harness socket.

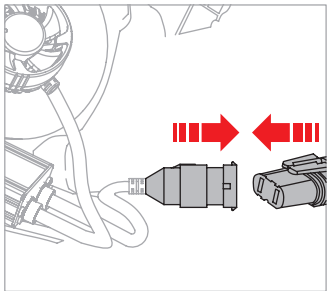

## STEP 5

**OPTIONAL:** If you ordered additional Decoder Harnesses to correct power signals on certain vehicles, plug the Decoder Harness in to the factory socket first, then connect the LED bulb to the Decoder Harness module. (See Decoder Harness instructions for detailed steps).

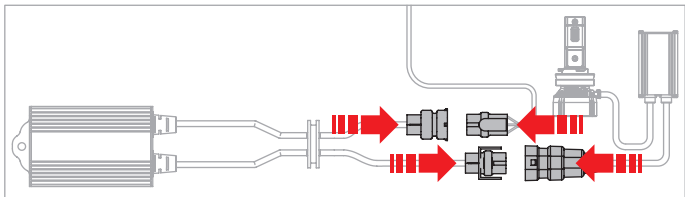

## STEP 6

**OPTIONAL:** LED bulbs are polarity sensitive. Please check the positive (+) and negative ground (-) signs before connecting the wires. If the bulb doesn't light up, disconnect the electrical connector and reverse it 180°, then reinstall.

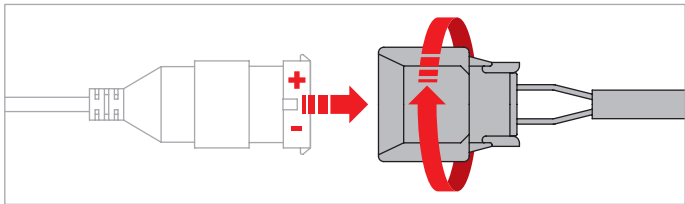

## CAUTION

Do not install the fan cooling LED bulbs in fog light applications without dust caps. Exposing the fan to excessive elements will shorten the life of the LED bulb considerably.

Do not press the fan at any time during installation. Too much force on the fan will damage the part and can cause premature failure.

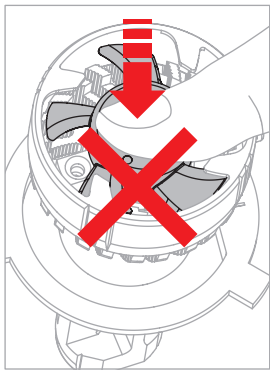

## STEP 7

Tuck and secure all wiring. If your lamp assembly use dust caps, the driver box and wiring can be tucked into the lamp assembly and sealed inside using the dust cap.

## STEP 8

As a result of replacing the bulb, the axis of the light may become misaligned. Confirm the alignment of your lamp assembly by following lamp assembly aiming procedures in your vehicle manual. Enjoy the modern LED appearance and increased output from your new Tiny Monster LED bulbs!

# ORIENTATION

Check to make sure the position of the diodes (LED chips) are in a horizontal side-to-side orientation.

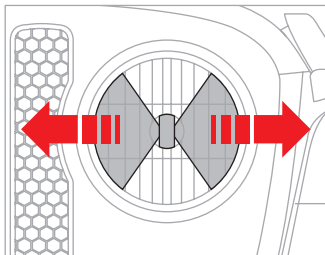
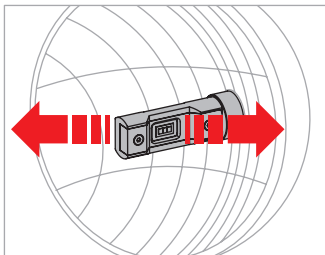

**NOTE:** Dual filament bulbs have two sets of LED chips. Ensure the chip alignment matches the illustration below.

## H4

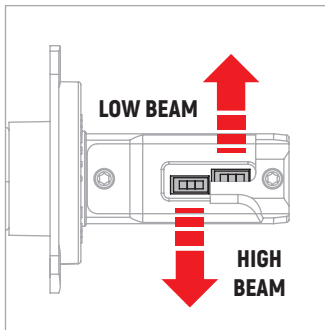

## H13/9007/9004

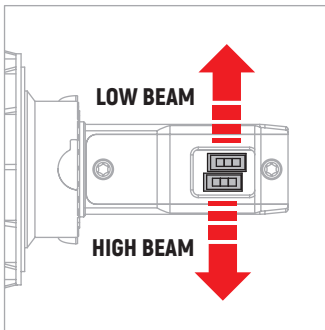



# **XTREME BULB**

## **SERIES**

Our Tiny Monster bulbs pack scary power in slim, sleek designs. They're compact and powerful and packed with the latest LED technology.

<b>COLOR TEMPERATURE</b>	<b>6500K</b>
<b>LEDS</b>	<b>HIGH-OUTPUT LEDS</b>
<b>POWER</b>	<b>40W / BULB</b>
<b>CURRENT</b>	<b>2.9A @ 13V DC / BULB</b>
<b>VOLTAGE</b>	<b>9 - 16V DC</b>
<b>WATERPROOF</b>	<b>IP65</b>

## **FEATURES**

- Powerful white light for improved visibility
- Precision optics designed for long range visibility and zero glare
- Vacuum heat pipes allows for efficient cooling
- Built in advanced temperature regulation provides dependable operation at full intensity
- Bulb head rotates 360° for optimal beam shape
- 2 year warranty



ARC LIGHTING  
(888) 608-2220 | [WWW.ARC.LIGHTING](http://WWW.ARC.LIGHTING)



# ADJUSTMENT

## H8/H9/H11/9005/9006/9012

1. Observe the angle of the LED diodes and to the correct angle needed.
2. Locate the set screw on the LED bulb collar.
3. Use the hex wrench provided to loosen the set screw.
4. Rotate the collar to the required position to achieve correct installation alignment.
5. Tighten the set screw.

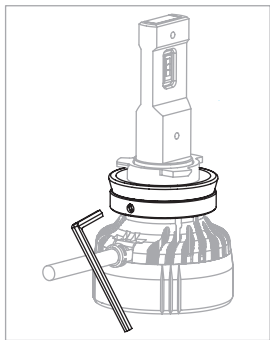

**CAUTION: Do not forcibly pull the bulb head or rotate it in excess of 180°.**

## H4/H7/H13/9007/9004

1. Observe the angle of the LED diodes and decide the correct angle for adjustment.
2. To adjust, push the bulb base inward with moderate force and turn the bulb counter clockwise to the correct angle.
3. Don't perform these steps while the bulbs are turned on. Adjust only when the bulb is in cool condition otherwise it may damage the bulb collar.

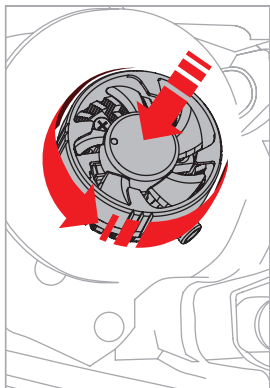

# TROUBLESHOOTING

## **1. Lights do not turn on:**

If the bulb does not light up, disconnect the electrical connector and reverse it 180°, then reinstall.

## **2. Incorrect beam pattern:**

If the beam pattern does not appear correct, or is skewed, carefully inspect the mounting and position of the bulb in the assembly. In most cases, this is due to misalignment or a problem with rotation. Make sure the bulb is vertically aligned in the socket, and adjust the rotation if necessary.

## **3. Light flickering / lights turn on and off intermittently / bulb out error on dash:**

If you experience flickering while the vehicle is running, or a bulb out error, you may need the decoder harness for your vehicles electrical system. Please contact us if the issue persists after the decoder harnesses are installed.

## **4. Fitment:**

In certain vehicles with dust caps, the LED bulb may not fit due to constraints off available space. Please contact us for assistance if it does not appear that the bulb will fit properly in your vehicle.

For more troubleshooting details please visit  
[www.arc.lighting/troubleshooting](http://www.arc.lighting/troubleshooting)

# REGULATIONS FOR USE OF LED BULBS IN HALOGEN HEADLIGHTS

ARC Lighting LED bulbs are tested as street legal in the United States for fog light use only. They are not compliant with DOT / FMVSS108<sup>①</sup> and are therefore not street legal in the USA for use as headlights. ARC Lighting LED bulbs are legal for off road use as headlights on Snowmobiles, ATVs, construction equipment and off road racing and enthusiast vehicles. International street legality will vary by country.

**Please note:** This usage regulation is not unique to ARC Lighting LED bulbs. Regardless of their marketing claims, all LED bulbs from other brands are prohibited from street use in halogen headlights in the United States<sup>②</sup>

① In the United States, lamps, reflective devices and associated equipment are regulated by the US Department of Transportation (DOT) National Highway Traffic Safety Administration's FMVSS108 document. DOT / FMVSS108 applies to all vehicles used on public streets in the United States. DOT regulated products must comply with DOT / FMVSS108 in order to be street legal in the United States. For example, headlights are regulated by DOT / FMVSS108 and must comply with DOT / FMVSS108 to be street legal in the USA. However, fog light bulbs are not regulated by DOT / FMVSS108 and are considered street legal in the USA.

② Vehicle lighting bulbs are classified by 'base fitment' type, universally by OEM and aftermarket industry standards. Fitment does not confirm street legality in the USA. Street legality in the United States for retrofitting bulbs varies by both vehicle usage and light type. Bulbs are not available for purchase for illegal street usage. We recognize select vehicles could be used on public streets or off road (not on public streets). Only vehicles which are strictly and 100% exclusively limited to off road use qualify as off road vehicles.

# DOT COMPLIANCE ACKNOWLEDGEMENT

Please check your usage on the chart below and confirm that you will not use the bulbs for illegal street usage:

<b>USAGE</b>	<b>DOT / FMVSS108 REGULATED</b>	<b>STREET- LEGAL</b>	<b>SALABLE</b>
Fog Lights (any vehicle)	NO	YES	YES
Street Driven Vehicle (DOT registered with license plates)	YES	NO	NO
Mixed use Vehicle (DOT registered with license plates, driven both on-road and off-road)	YES	NO	NO
Snowmobile, ATV, Off Road Racing or Enthusiast Vehicle, International Vehicle, Construction Equipment (Off-road use only)	YES	YES	YES

# WARRANTY

## Terms of this Warranty

ARC Lighting warranties all products from defects in material and workmanship for (2) two years from the retail date of purchase. This warranty applies only to the original purchaser and is non transferable. Your original sales receipt will serve as proof of purchase for this warranty. Before credit can be issued on a warranty claim, proof of defect may be required. This can be determined at the time of the claim.

## Exclusions of this Warranty

Not covered under this warranty is failure due to neglect, improper installation including any modifications, alterations, abuse, accident, weather related damage or by any type of impact.

## Repair and Replacement

In the event that your part is found to be defective under the terms of this warranty, it is at the discretion of ARC Lighting to repair or replace the defective part. All repairs must be made under the direction of ARC Lighting. ARC Lighting is not responsible for any removal, installation, reinstallation, or transportation costs associated with the warranted claim.

Please submit any warranty claim at [www.arc.lighting/warranty](http://www.arc.lighting/warranty). It only takes a few minutes to complete and streamlines the process.