

GENUINE ACCESSORIES

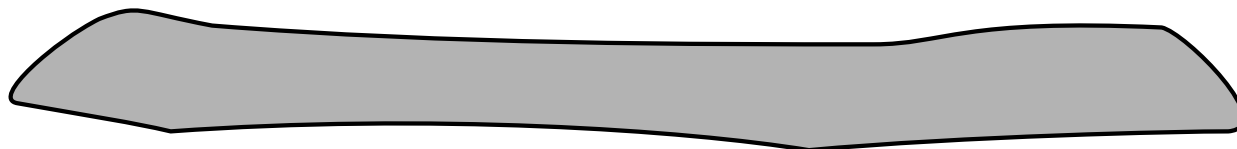

GB

INSTALLATION INSTRUCTION FRONT AIR DEFLECTOR

E

INSTRUCCIONES DE MONTAJE DEFLECTOR DE AIRE FRONTAL

F

NOTICE DE MONTAGE DÉFLECTEUR D'AIR AVANT

JP

取り付け説明 フロントデフレクター

Subject to alteration without notice
Reservadas modificaciones técnicas
Sous réserve de modifications techniques



07-2000

I-844

© DAIMLERCHRYSLER

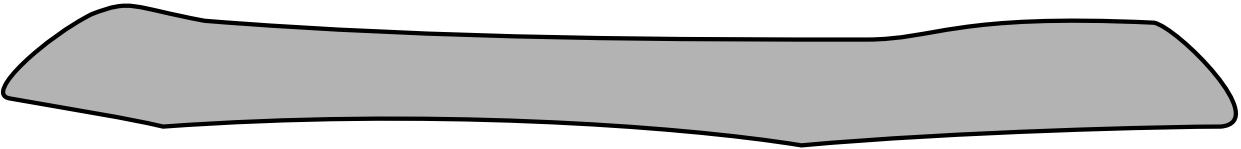
GENUINE ACCESSORIES

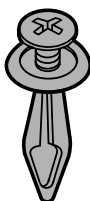
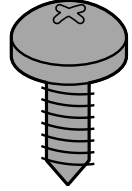
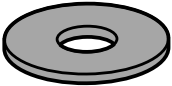
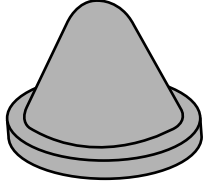

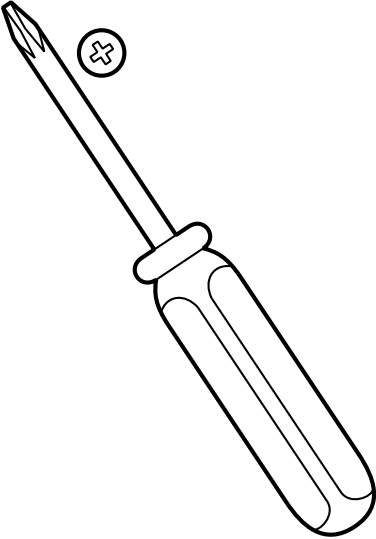
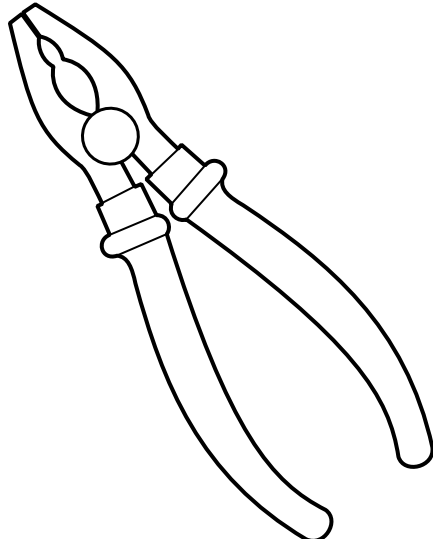
A			
X4		X2	
B		C	#14 x 1/2"
X2		D	X4
E			
F			
			

GENUINE ACCESSORIES

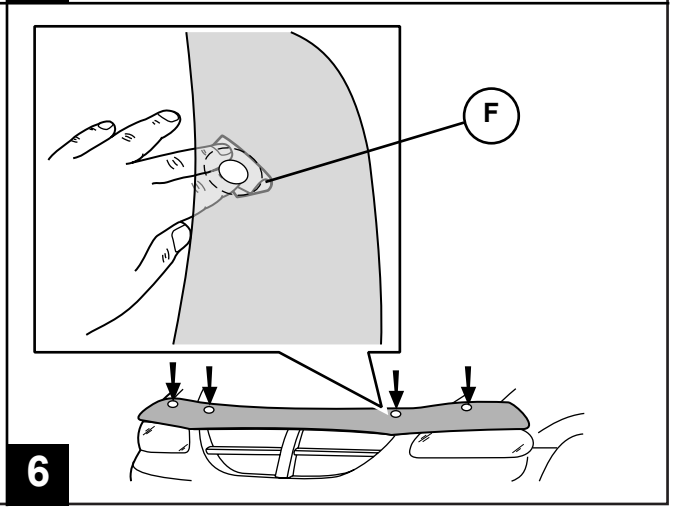
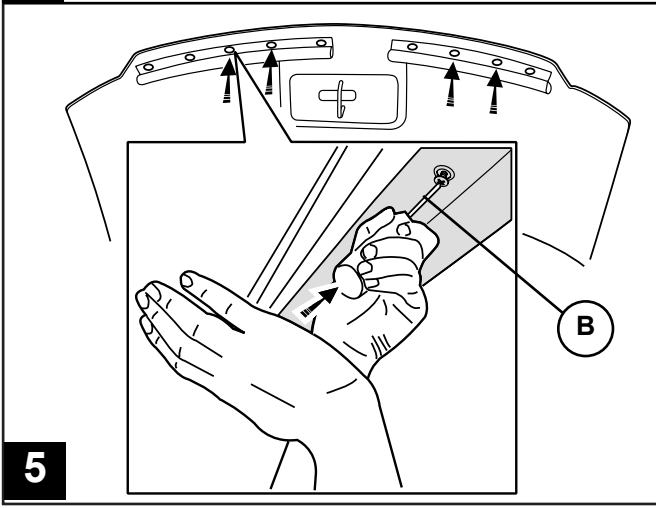
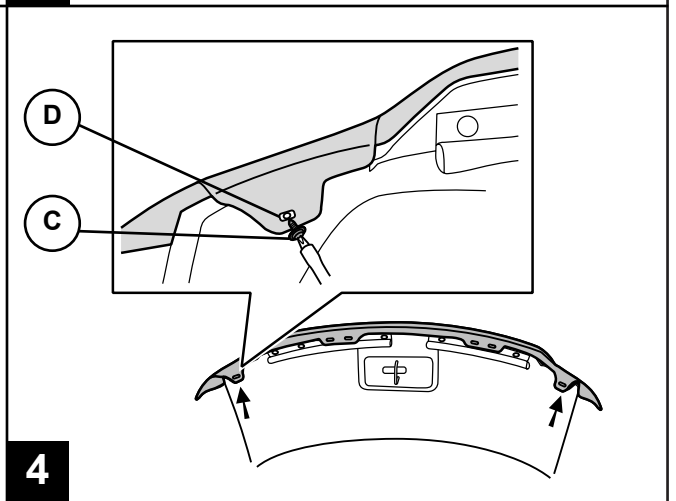
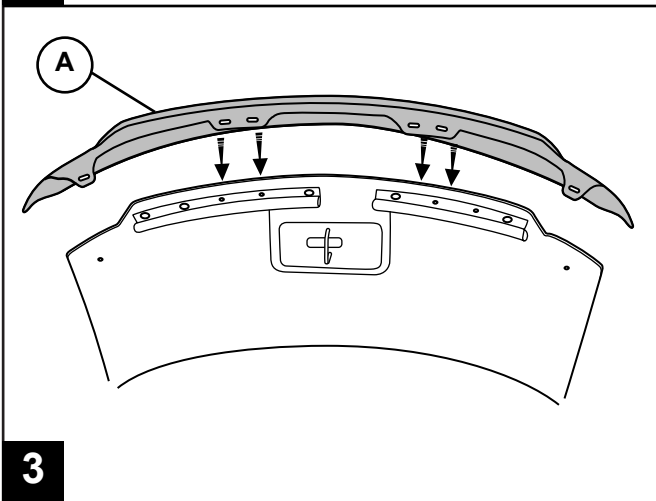
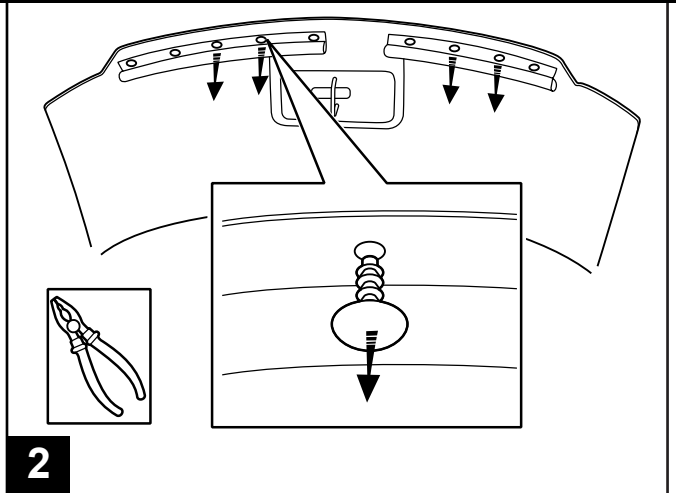
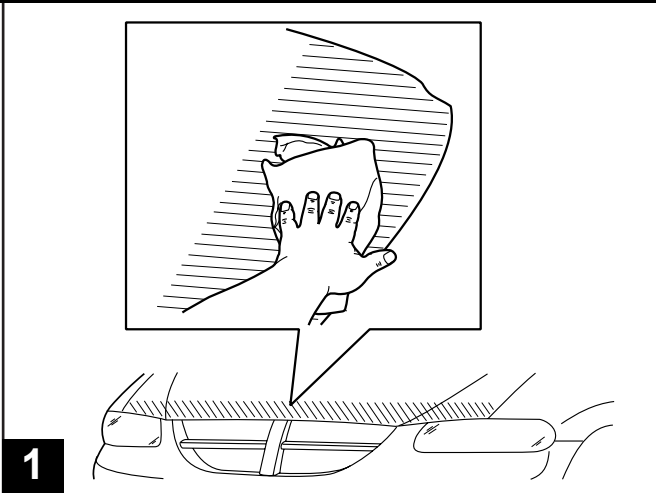



GENUINE ACCESSORIES

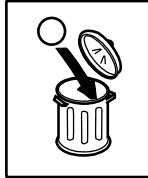
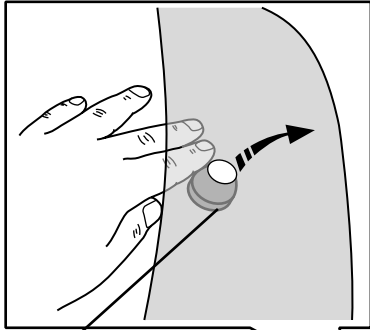

E

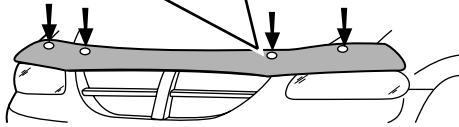

7