

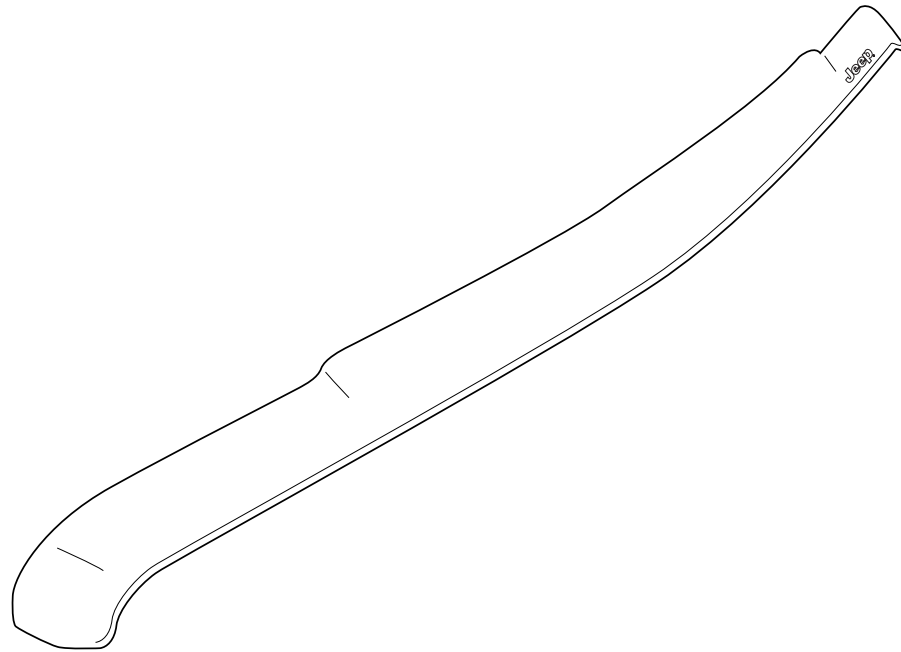

2007 thru 2012 w/o SEAL / 2013 and later w/SEAL Jeep Patriot Front Air Deflector

GENUINE ACCESSORIES



A X1



B X1



C X4



D X4



E X2

GB

INSTALLATION INSTRUCTION

FRONT AIR DEFLECTOR

Parts must not be fitted until registration of the vehicle has been obtained.

F

NOTICE DE MONTAGE

AIR AVANT DÉFLECTEUR

Ne pas monter les pièces avant l'enregistrement du véhicule.

E

INSTRUCCIONES DE MONTAJE

CUBIERTA PARA CAPÓ DELANTERO

No se permite montar las piezas antes de registrar el vehículo.

Subject to alteration without notice
Reservadas modificaciones técnicas
Sous réserve de modifications techniques

Expert Fitment Required
Montaje sólo por el concesionario
Montage par spécialiste nécessaire

GENUINE ACCESSORIES

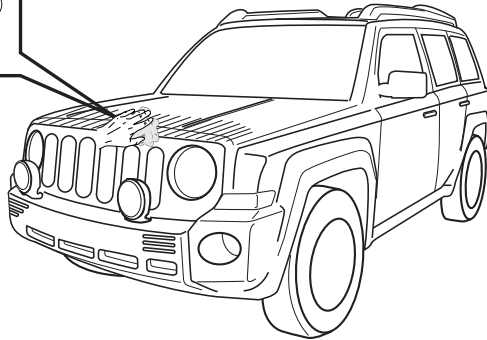

1

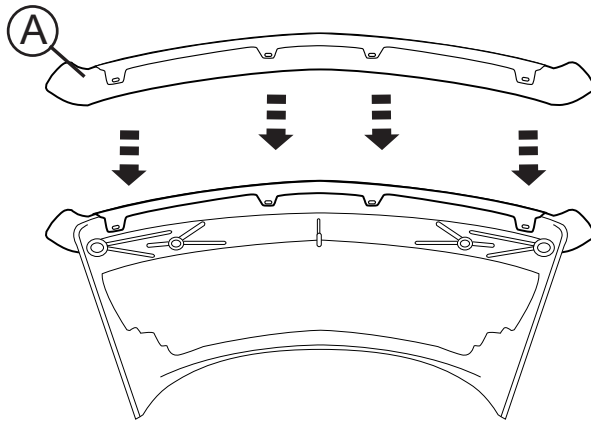

2

On vehicles equipped with seals insert deflector shield between seal and hood outer.
Sur les véhicules équipés de joints insert déflecteur bouclier entre le joint et le capot externe.
En los vehículos equipados con sellos de inserción escudo deflector entre el sello y la capucha externa.

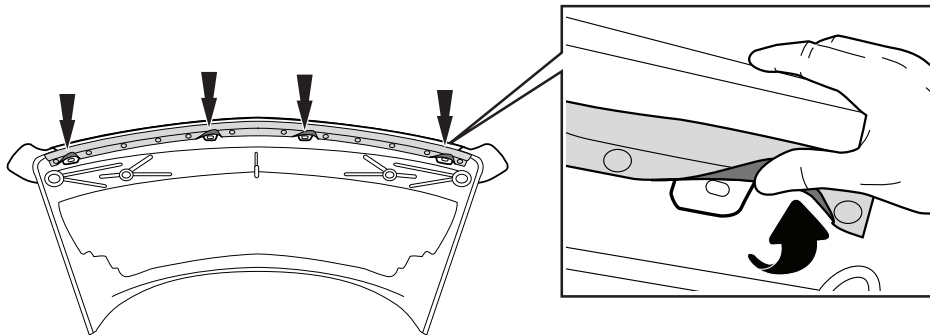

3

GENUINE ACCESSORIES

 x4

On hood inner mark location's to be drilled with grease pencil 4 places.
Le capot lieu de recherche interne est à forer avec un crayon gras 4 places.
En la campana marque la ubicación interior es a perforar con lápiz graso 4 lugares.

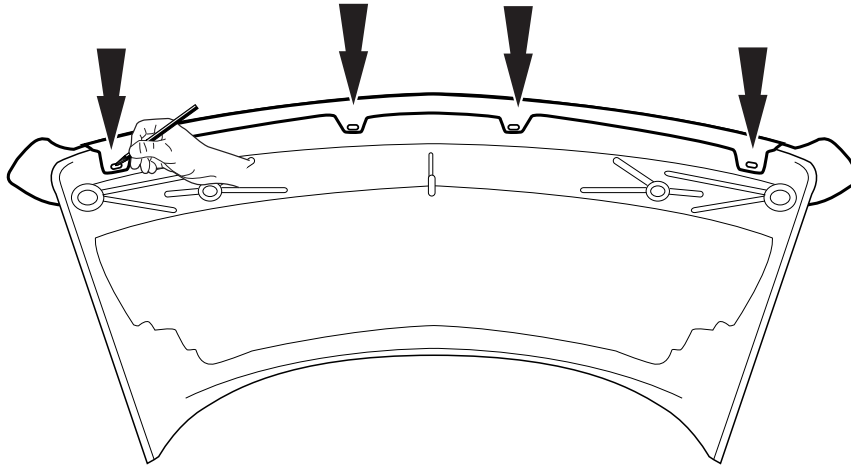

4

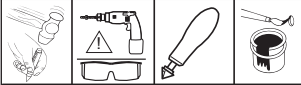

Remove deflector and center punch and using a 4.5mm, or .177 drill hole in hood inner being sure not to drill through hood outer. Apply anti-corrosion to drilled holes.

Retirer déflecteur et le centre punch et en utilisant un 4.5mm, ou .177 trou dans le capot intérieur étant sûr de ne pas percer le capot extérieur. Appliquer anti-corrosion de trous percés.

Retire el deflector y el punzón y el uso de un 4,5 mm o 0,177 perforación en la capilla interna asegurándose de no perforar a través de la campana exterior. Aplicar contra la corrosión a los agujeros perforados.

x4

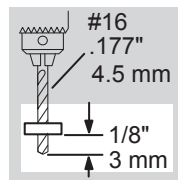
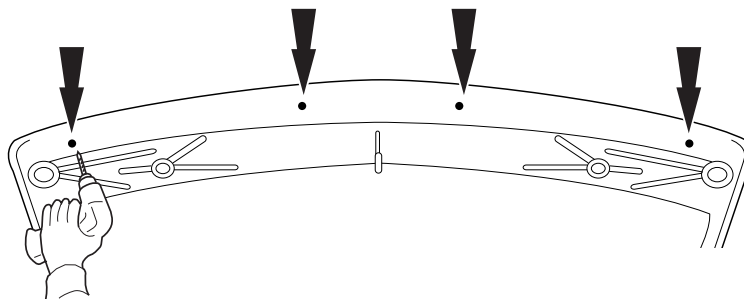

NOTE: DO NOT DRILL THROUGH HOOD.

NOTE: Ne pas percer PAR HOOD.

NOTA: NO perforar a través de la campana.

5

GENUINE ACCESSORIES



Remove adhesive backing from pad and apply to the 2 inner tab locations.
Retirez revers adhésif de tampon et appliquez les 2 emplacements de languette intérieure.
Quite el forro adhesivo de la almohadilla y se aplican a los 2 lugares lengüeta interior.

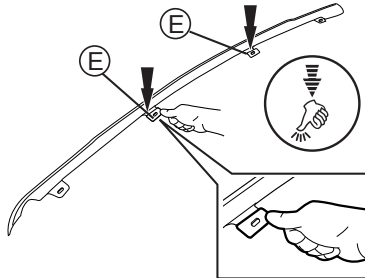

6

Reinsert deflector between the seal and the hood inner, remove other backing from pad and press in to location over holes in hood inner.

Réinsérer déflecteur entre le joint et le capot intérieur, retirez autre support de pad et appuyez sur l'endroit sur les trous dans le capot intérieur.
Vuelva a colocar el deflector entre la junta y la parte interna del capó, retire otro de respaldo de la almohadilla y pulse en la ubicación sobre los agujeros en la capilla interna.

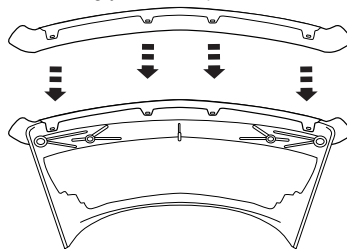

7



x4

Using supplied fasteners attach deflector to hood inner as indicated.
Utilisant les fixations fournies attacher déflecteur capot intérieur comme indiqué.
Utilizando elementos de fijación suministrados adjuntar deflector interno del capó como se indica.

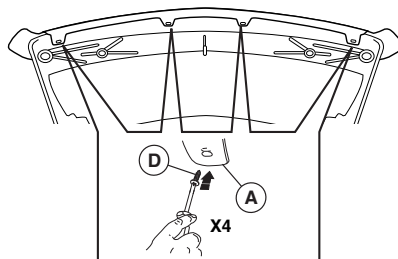

8



Using supplied alcohol wipe clean hood where rubber bumper to be installed and install as indicated.

Consommer de l'alcool fourni essuyer capot propre où pare-chocs en caoutchouc pour être installé et installer comme indiqué.

El uso del alcohol suministrado limpie hood limpio donde deba instalarse parachoques de goma e instalar como se indica.

x4

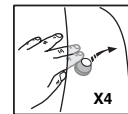
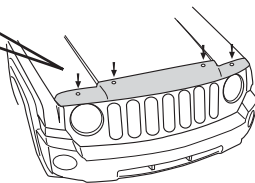
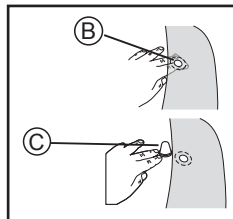

9