

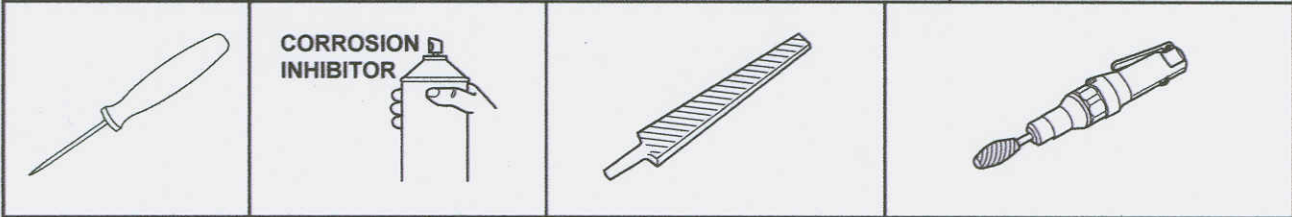

5th Wheel/Gooseneck Harness Kit Installation and Operation Instructions

MOPAR®

Be sure that this document is given to the end user of this product. This contains many important items relating to the proper usage of this product.

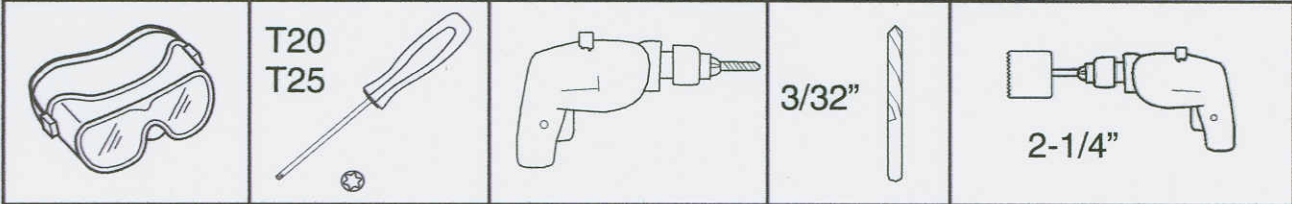
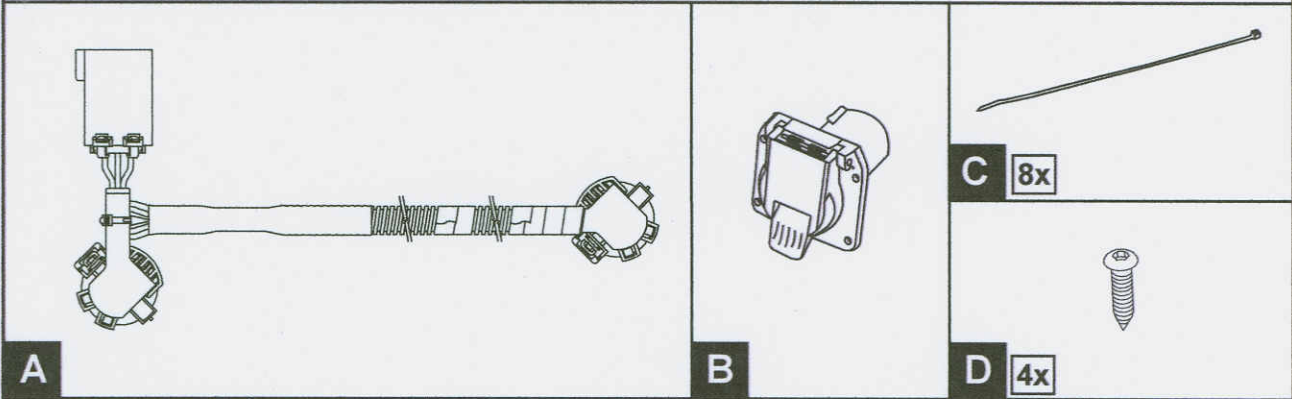

Begin installation by removing the driver side tail light. Using a T20 Torx driver, remove the two screws, and carefully pry the tail light housing away from the vehicle. Set screws aside in an area where they will not be lost.

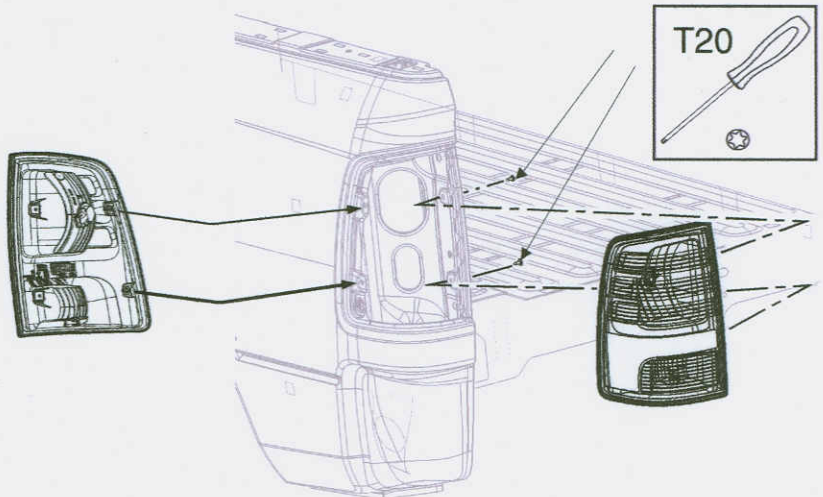

1

Locate the vehicle's two tail light connectors. Separate the connectors by pulling back locking clip. Gently pull the connectors apart while holding down the connector locking latch. Set tail light aside in an area where it will not be damaged.

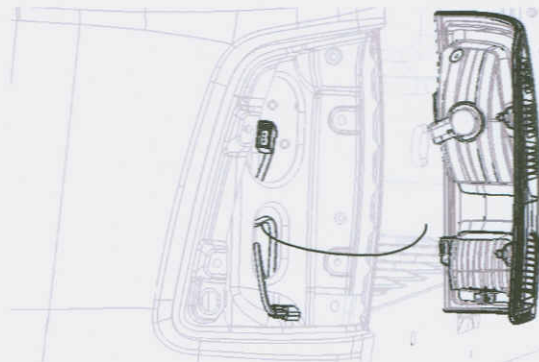

2

Locate the vehicle's factory trailer light wiring harness. The harness will be connected to the vehicle's 7-Way/4-Flat connector which is mounted to the bumper at the rear of the vehicle. The harness will have a connector similar to the paired connectors on the Gooseneck/5th Wheel Harness #A

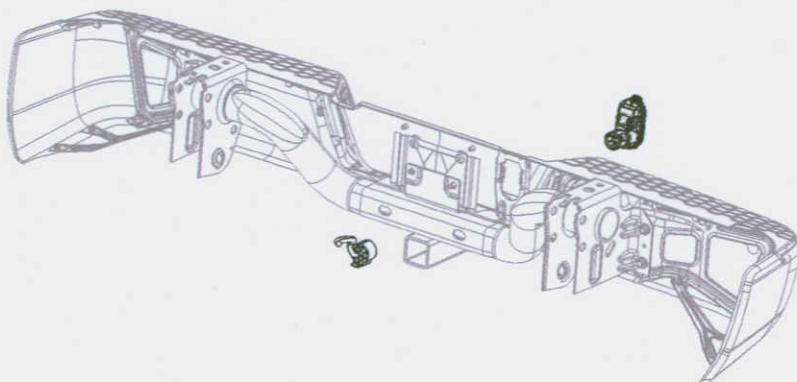

3

Separate the 7-Way connector from the vehicle wiring harness by gently pulling the connector and harness apart while holding down the connector locking latch.

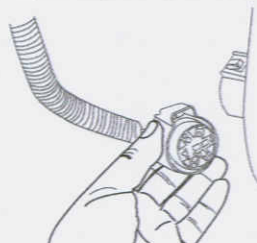

4

Position the paired connectors of the Gooseneck/5th Wheel Harness #A between the factory trailer light wiring harness and the 7-Way/4-Flat connector. Insert the longer of the paired connectors into the vehicle's harness connector, firmly pressing together until locking tabs engage. Insert the shorter of the paired connectors into the rear of the 7-Way/4-Flat socket, pressing firmly to engage the locking tab.

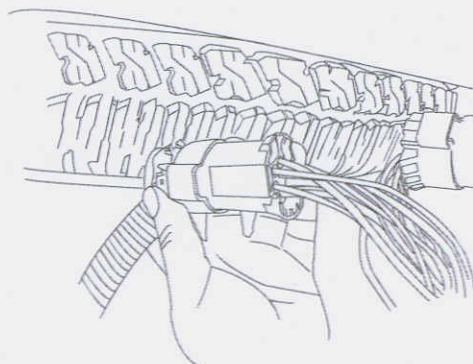

5

Route the remainder of the harness over the frame rail and through the bottom of the tail light pocket hole area on the Driver side. See Illustration. Using the (8) Cable Ties #C. Secure harness to the vehicle.

CAUTION: Make sure to avoid areas that could cut, pinch or burn the wires when routing the harness across the vehicle.

Continue to route the harness to the tail light pocket area.

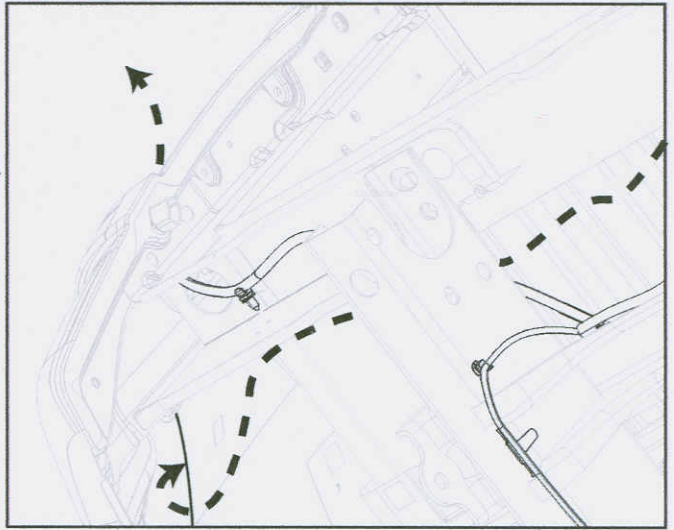

6

This vehicle has two different bed options. On Standard Models, the opening in the tail light pocket is too small for the harness to route through to the tail light pocket area, follow optional steps 8 or 9 to allow harness to be routed out to the tail light pocket area.

If the vehicle is a Dually Model, route harness through the opening as illustrated in the Dually Model Illustration and proceed to step 10.

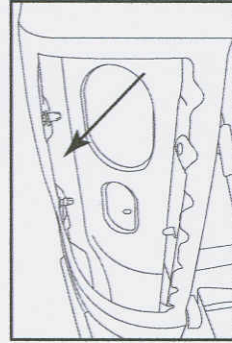

Standard Models

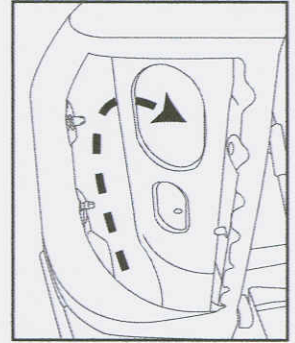

Dually Models

7

OPTIONAL: From underneath the vehicle on the Driver side, locate the access hole that exits at the tail light pocket area. Using a grinder or file, open the hole large enough for the harness connector to pass through the hole to exit to the tail light pocket area. Spray Corrosion Inhibitor on any area that was ground, filed or cut.

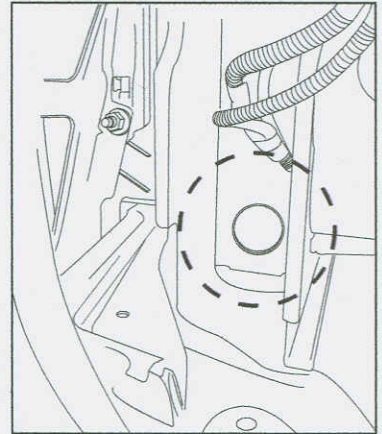
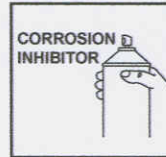
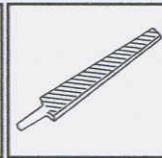
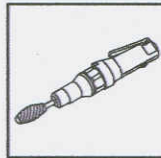

8

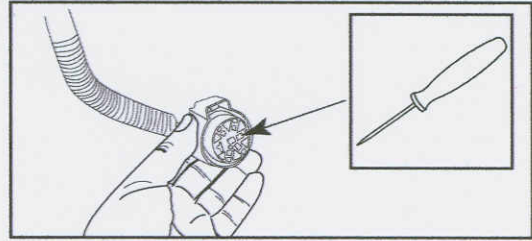
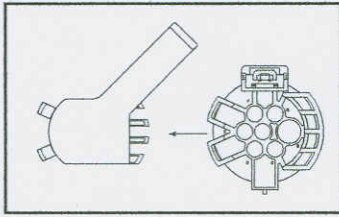

OPTIONAL: Untape the split loom tubing at the end of the harness near the connector. Remove the grey connector lock. Using a small pick tool, gently pull up each locking tab and slide terminal out of the cavity. Repeat this procedure for all Seven (7) cavities. Tape terminals together to prevent damage and route harness out through to the tail light pocket area. After the harness is routed out to the tail light pocket area, follow the illustration to the right to re-assemble the harness connector. Place the grey connector back onto the connector and re-tape.

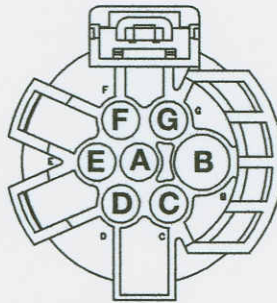

A	Red Wire
B	White Wire
C	Blue Wire
D	Green Wire
E	Black Wire
F	Brown Wire
G	Yellow Wire

(Connector Shown on Wire Side)

9

Using a 2-1/4" Hole Saw, drill a hole in the pillar area as shown through to the tail light pocket area.

NOTE: If a bedliner is present, a hole will first need to be drilled through the bedliner. Remove the plastic that was drilled out and then continue to drill through the pillar. Spray Corrosion Inhibitor in the cut area.

CAUTION: Ensure the vehicle is not equipped with a bed extender. If a bed extender is present, drill the hole above the extender bracket making sure there is enough clearance for the bed extender to rotate without interference from the 7-Way connector.

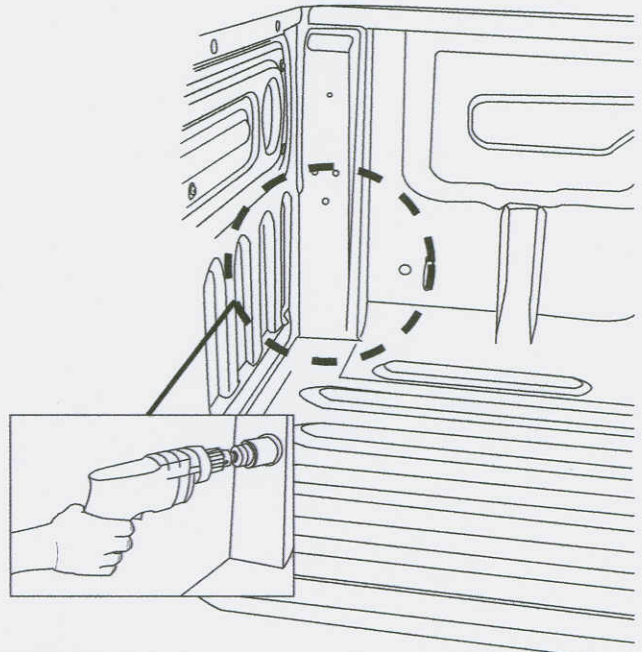

10

Place the 7-Way Connector #B into the drilled hole. Using the connector as a template. Drill the four mounting holes.

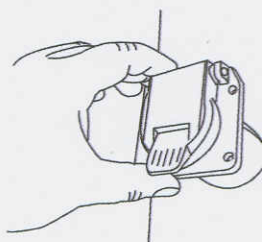

11

Route the harness that was routed out of the tail light pocket area through the 2-1/4" drilled hole.

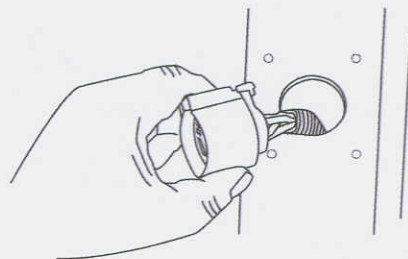

12

Insert the harness connector into the rear of the 7-Way Connector #B, pressing together firmly to engage locking tab. Route the wiring back into the hole. Line up the 7-Way Connector mounting holes with the holes drilled in Step 8. Using a T25 Torx driver, mount the 7-Way Connector #B using the (4) Mounting Screws #D. Confirm harness operation with a test light or a properly equipped trailer.

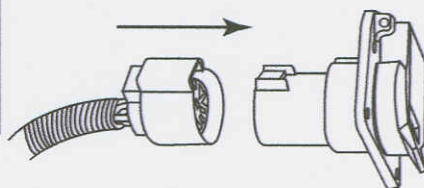
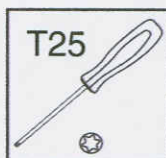

13

Reinstall the vehicle's tail light assembly removed in Step 2. Begin by connecting the two tail light connectors. Be sure to press firmly to ensure locking of the connectors. Align the tail light housing up with the mounting tabs and put tail light back into place. Using a T20 Torx driver, reinstall the two screws removed in Step 1.

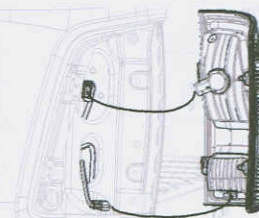
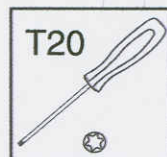

14

For information or Technical Support regarding this product call: 1-800-344-3230