

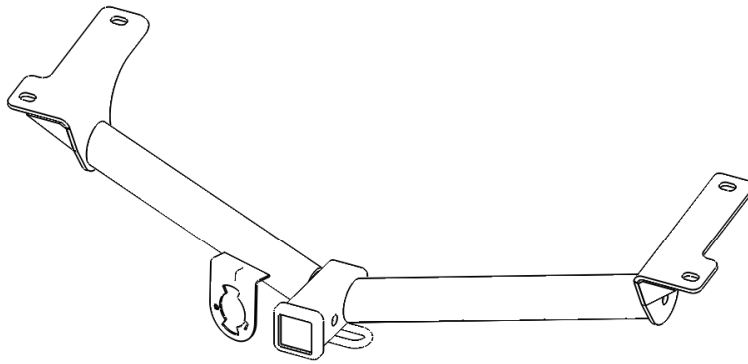

DODGE JOURNEY

Trailer Hitch

1



**A**

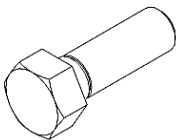

**B** 2x

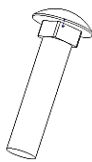

**C** 2x

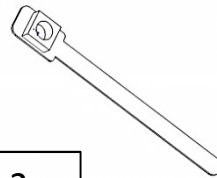

**D** 2x

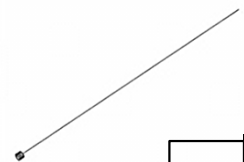

2x **E**

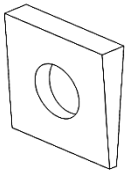

**F** 4x



**G** 2x

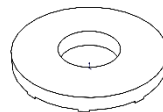

**H** 4x

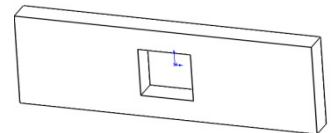

**I** 2x

**Tools Required**

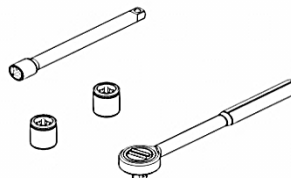
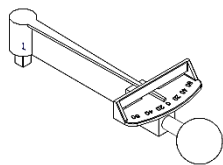
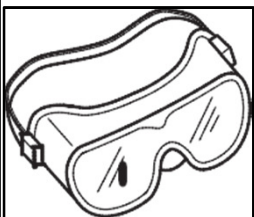

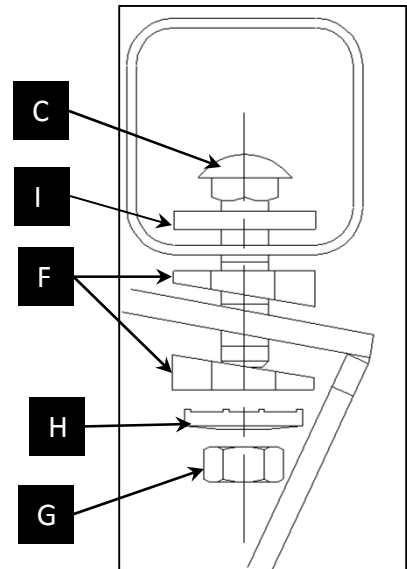
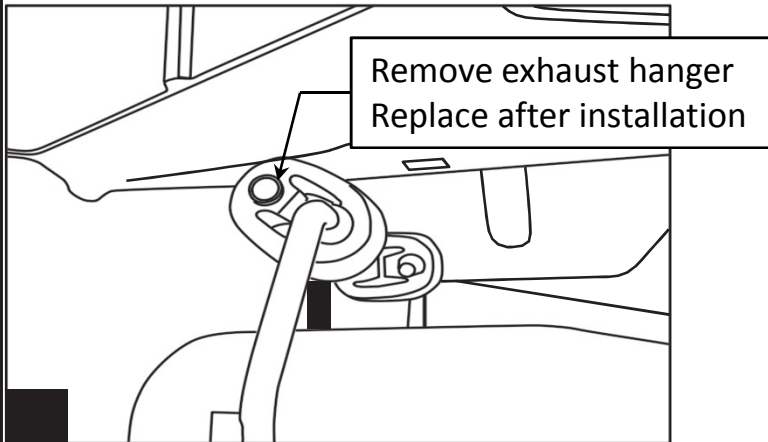

Wrap 'E' around threads (C). Slip through hole in frame. Pull bolt until seated. Remove and discard after use

Note: Fasteners typical both sides

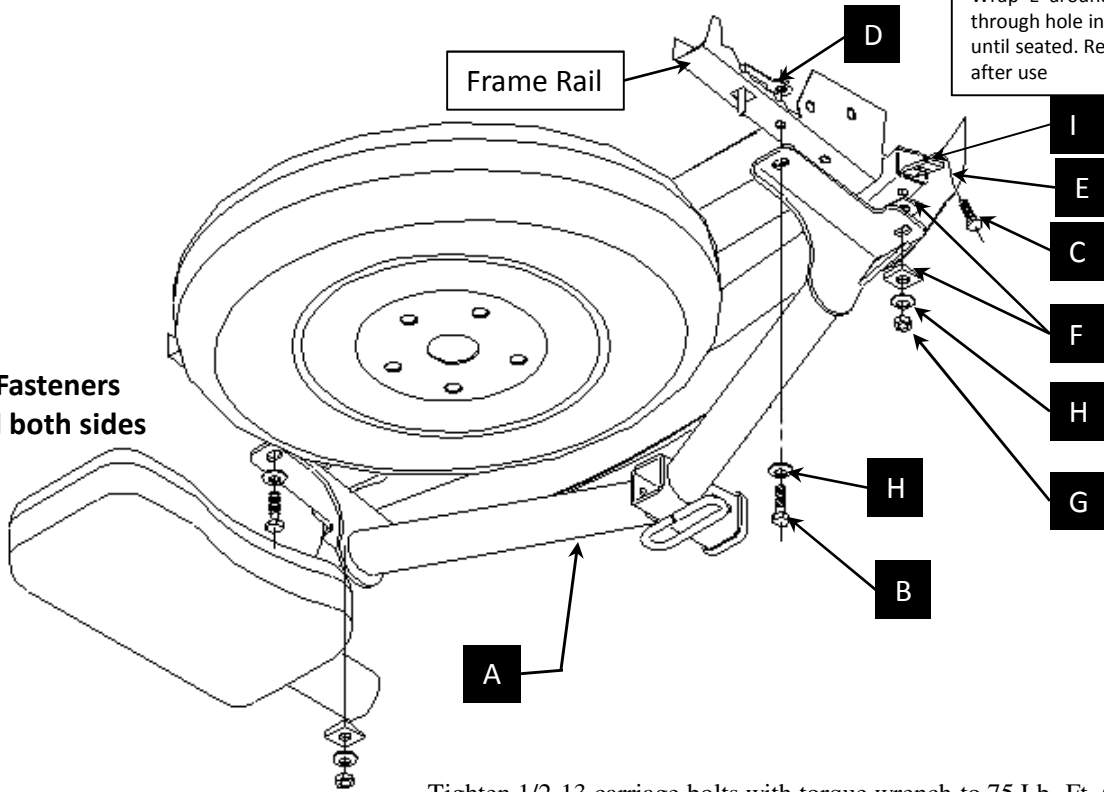

Tighten 1/2-13 carriage bolts with torque wrench to 75 Lb.-Ft. (102 N\*M)  
Tighten 1/2-13 Handle nuts with torque wrench to 50 Lb.-Ft. (68 N\*M)

Note: check hitch frequently, making sure all fasteners and ball are properly tightened. If hitch is removed, plug all holes in trunk pan or other body panels to prevent entry of water and exhaust fumes. A hitch or ball which has been damaged should be removed and replaced. Observe safety precautions when working beneath a vehicle and wear eye protection. Do not cut access or attachment holes with a torch. This product complies with safety specifications and requirements for connecting devices and towing systems of the state of New York, V.E.S.C. Regulation V-5 and SAE J684.