

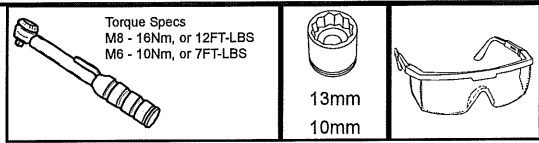

RAM SIDE STEP  
ESTRIBO RAM  
MARCHEPIED DE RAM

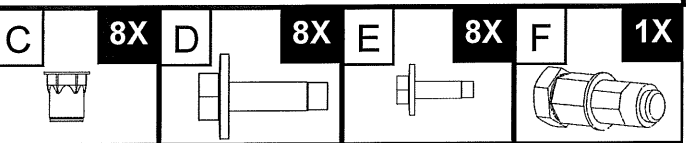
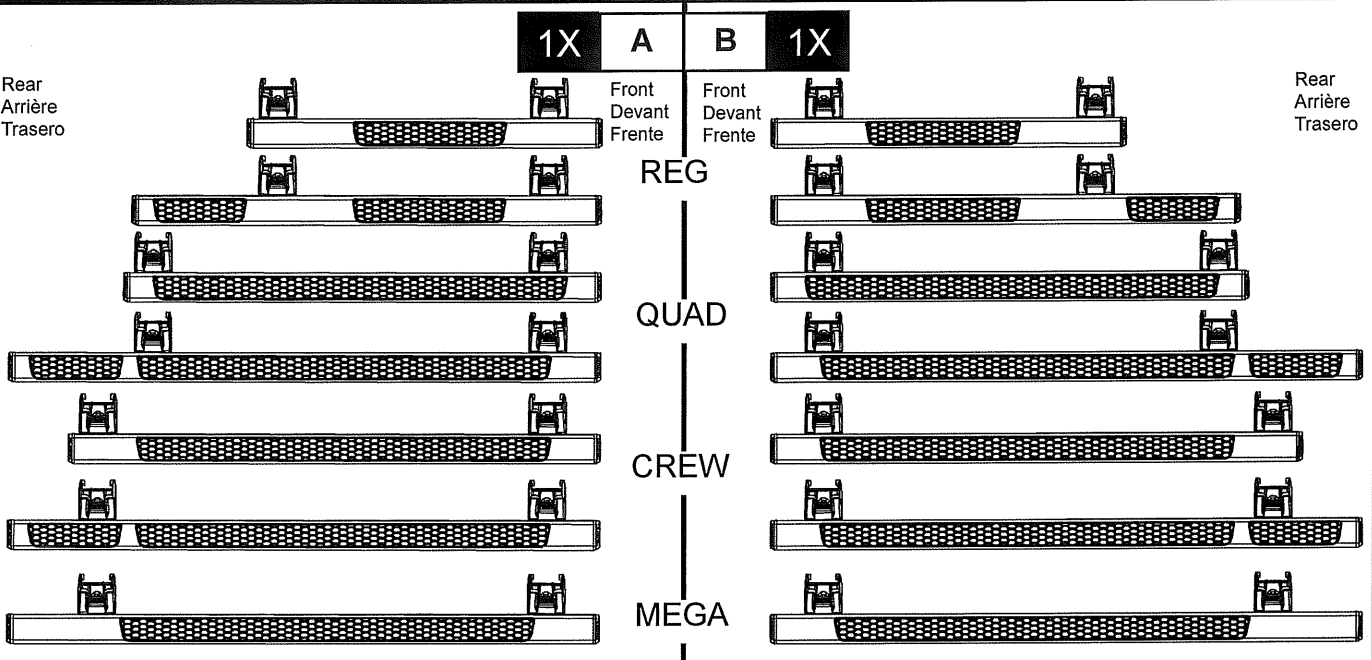

Lubricate the riv-nut tool using fresh motor oil for lubricant and clean rivnut threads with brake cleaner after installed on vehicle.

Apply 25Nm +/-1.5Nm of torque to the riv-nut tool. If a torque wrench is not available rotate the riv-nut tool for 3.5 turns +/- 0.25 turn to ensure riv-nut is fully collapsed.

Important: Upon installation riv-nut flange should be flat and tight to the sheet metal. Riv-nut should not have any slack.

Caution: Use riv-nut tool pt# 82212003 to properly install riv-nuts. Do not use any other method to collapse riv-nuts.

1 Re-lubricate the riv-nut tool before installing every rivnut.

FRONT OF VEHICLE  
DEVANT DU VEHICULE  
PARTE DELANTERADEL VEHICULO

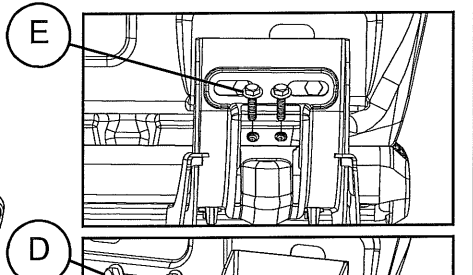
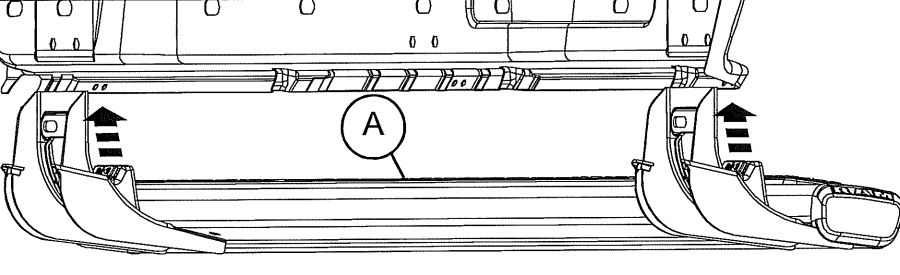
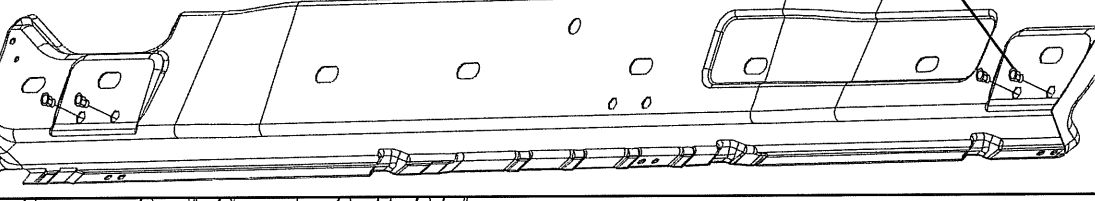

Warning: This side step reduces your vehicle's ground clearance. It is not intended for off-road use.  
La advertencia: Este paso del lado reduce el espacio libre del suelo de su vehículo. No es pensado para el uso todoterreno.  
Avertissement : Cette étape latérale réduit le dégagement du sol de votre véhicule. Il n'est pas voulu pour l'usage tout-terrain.

Care: Chrome Cleaner - Excellent chrome surfaces cleaner. Ideally suited for all bright metals. Specifically formulated for use on surfaces that are exposed to weather or water. Part No. 04318013  
Soin : Le Nettoyeur chromé - le chrome Excellent apparaît le nettoyeur. Idéalement adapté pour tous les métaux brillants. En particulier formulé pour l'usage sur les surfaces qui sont exposés pour l'eau ou temps. Part No. 04318013

2 El cuidado: Cromo Limpiador - Excelente limpiador de superficies de cromo. Idealmente convenido para todos los metales brillantes. Especificamente formulado para el uso en superficies que son expuestas de capear o regar. Part No. 04318013

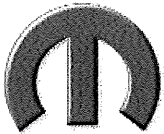

RAM WHEEL TO WHEEL SIDE STEP  
 ESTRIBO RUEDA DE RUEDA RAM  
 MARCHPIED UNE ROUE À L'AUTRE RAM

MOPAR®

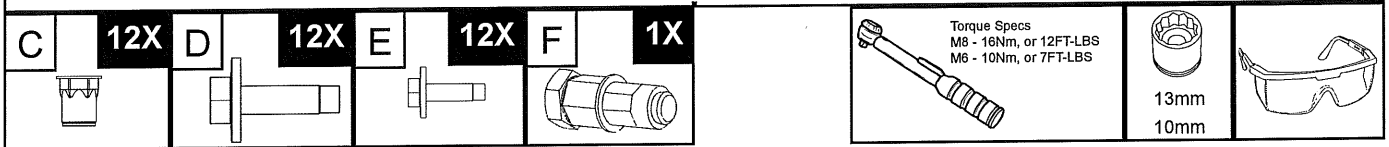
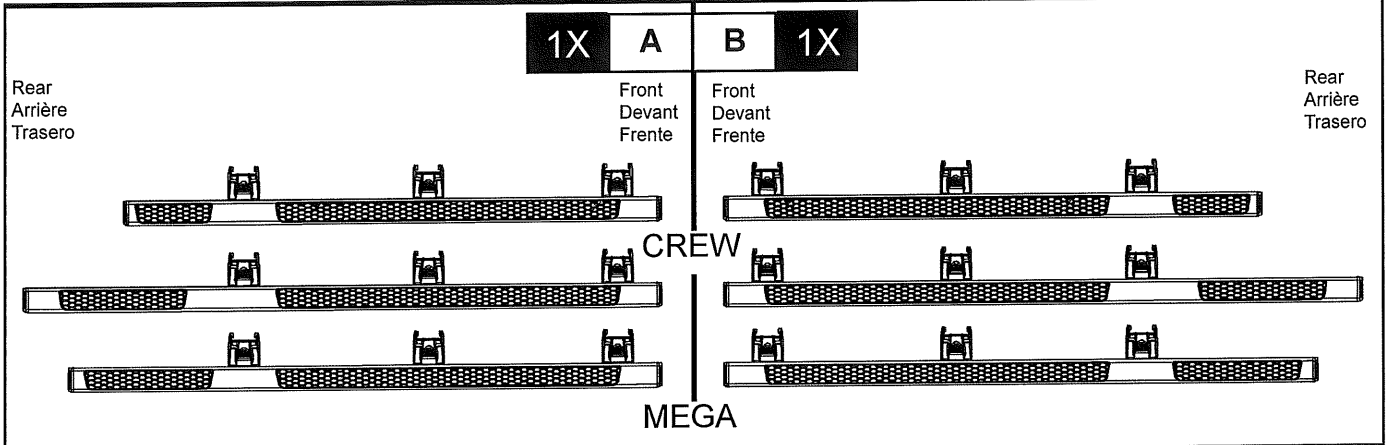

Lubricate the riv-nut tool using fresh motor oil for lubricant and clean rivnut threads with brake cleaner after installed on vehicle.

Apply 25Nm +/-1.5Nm of torque to the riv-nut tool. If a torque wrench is not available rotate the riv-nut tool for 3.5 turns +/- 0.25 turn to ensure riv-nut is fully collapsed.

Important: Upon installation riv-nut flange should be flat and tight to the sheet metal. Riv-nut should not have any slack.

Caution: Use riv-nut tool pt# 82212003 to properly install riv-nuts. Do not use any other method to collapse riv-nuts.

Re-lubricate the riv-nut tool before installing every rivnut.

FRONT OF VEHICLE  
 DEVANT DU VEHICULE  
 PARTE DELANTERA DEL VEHICULO

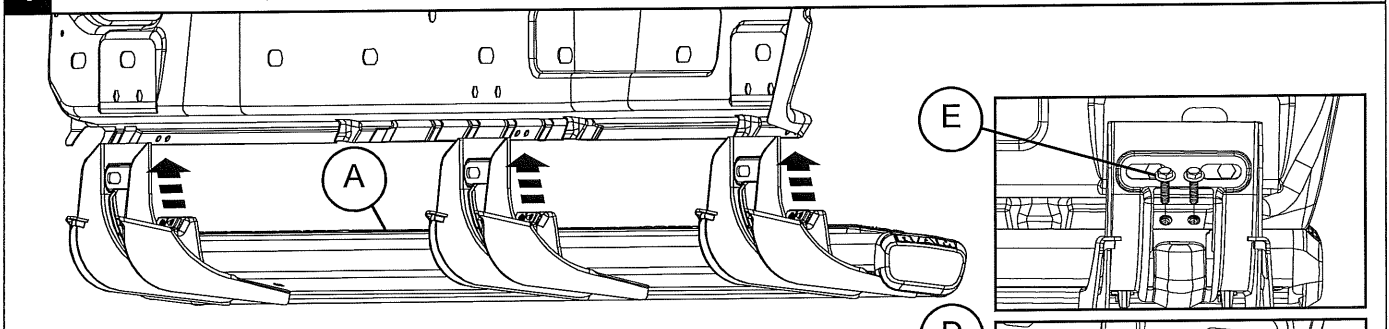
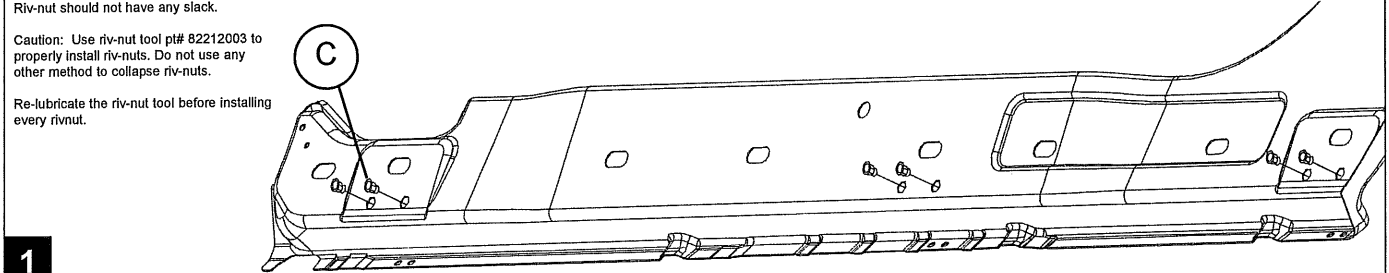

Warning: This side step reduces your vehicle's ground clearance. It is not intended for off-road use.  
 La advertencia: Este paso del lado reduce el espacio libre del suelo de su vehículo. No es pensado para el uso todoterreno.  
 Avertissement: Cette étape latérale réduit le dégagement du sol de votre véhicule. Il n'est pas voulu pour l'usage tout-terrain.

Care: Chrome Cleaner - Excellent chrome surfaces cleaner. Ideally suited for all bright metals. Specifically formulated for use on surfaces that are exposed to weather or water. Part No. 04318013  
 Soin: Le Nettoyeur chromé - le chrome Excellent apparaît le nettoyeur. Idéalement adapté pour tous les métaux brillants. En particulier formulé pour l'usage sur les surfaces qui sont exposés pour l'eau ou temps. Part No. 04318013  
 El cuidado: Cromo Limpiador - Excelente limpiador de superficies de cromo. Idealmente convenido para todos los metales brillantes. Específicamente formulado para el uso en superficies que son expuestas de cepear o regar. Part No. 04318013

