

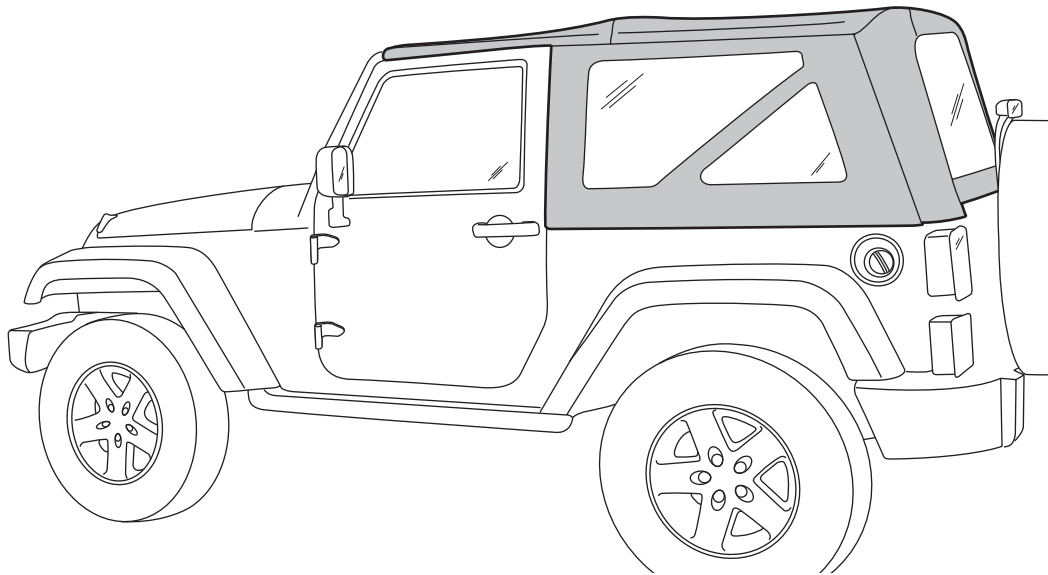

JEEP WRANGLER

2 Door Top Kit



82213649
82213650

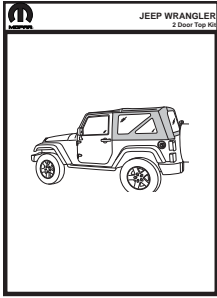

K6861727

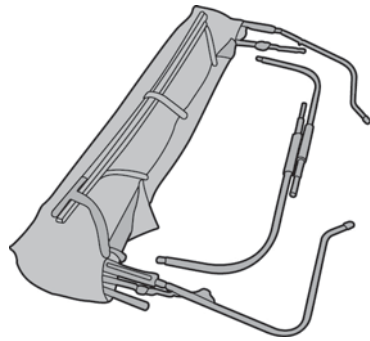

A 1X

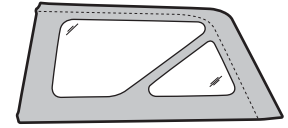

B 1X LH

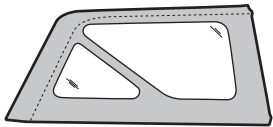

C 1X RH

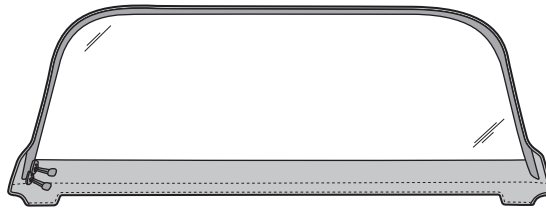

D 1X

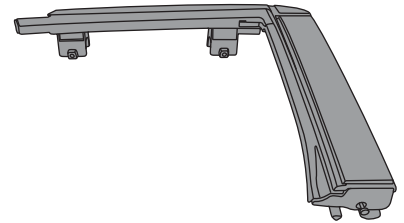

E 1X LH

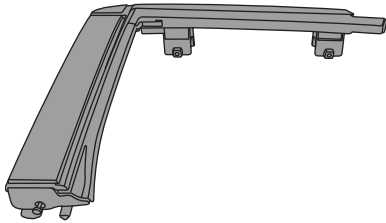

F 1X RH

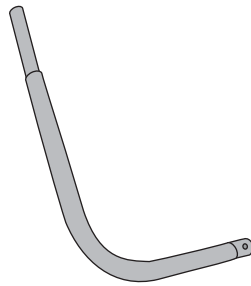

G 1X LH

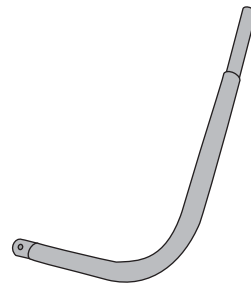

H 1X RH

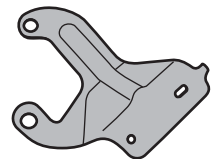

I 1X LH

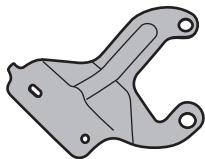

J 1X RH

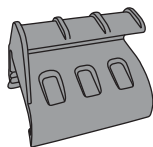

K 1X LH

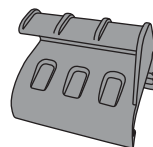

L 1X RH



M 1X

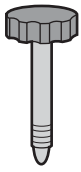

N 4X

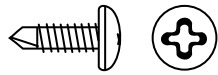

O 2X

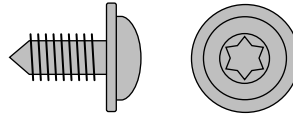

P 4X

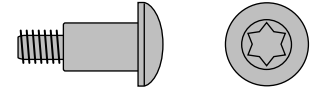

Q 4X

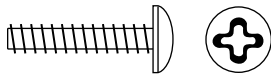

R 2X

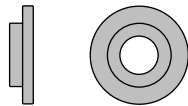

S 4X

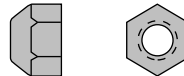

T 2X

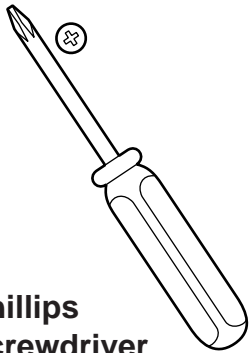

**Phillips
Screwdriver
Sizes 1, 2 and 3**

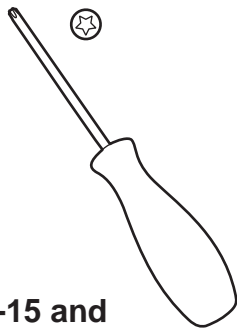

**T-15 and
T-30 Torx**

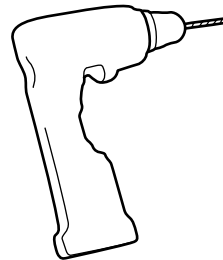

**Drill
#2 Phillips Bit**

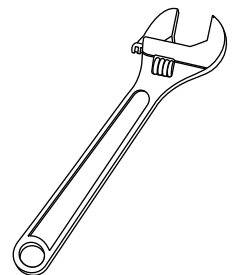

**Adjustable
Wrench**

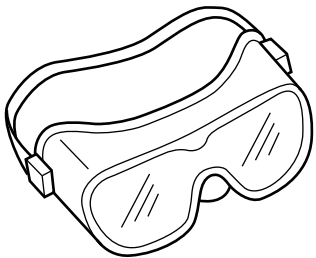

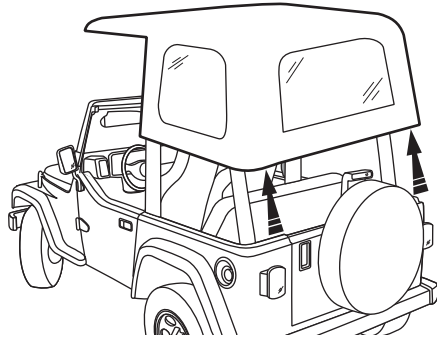

Remove the hard top.
Refer to owner's manual
for instructions.

1

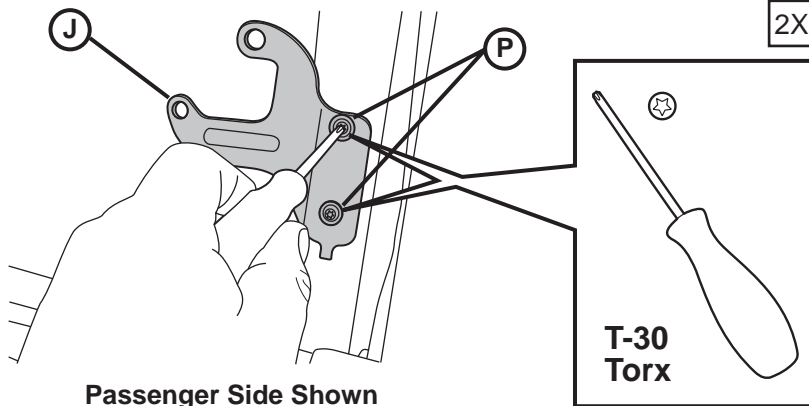

Use Bracket Screws
to install Bow Mount
Brackets on rear sport
bar.

2

Passenger Side Shown

T-30
Torx

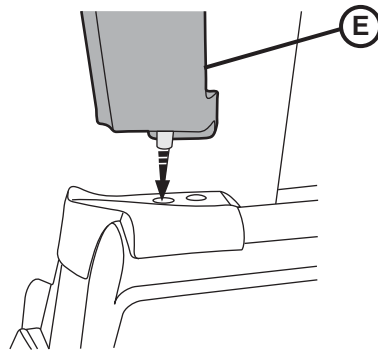

Locate the left and right
Door Surrounds. Insert
the pin in the bottom of
the Door Surround into
the hole in the belt rail
behind the door.

3

Driver's Side Shown

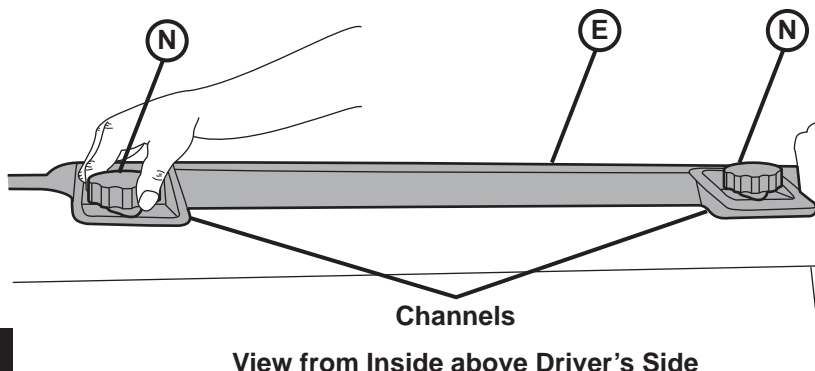

Press the channels
along the top of the
Door Surround around
the horizontal sport bar,
above the door opening.
Insert two Knobs into
the Door Surround and
tighten them down.

4

Channels
View from Inside above Driver's Side

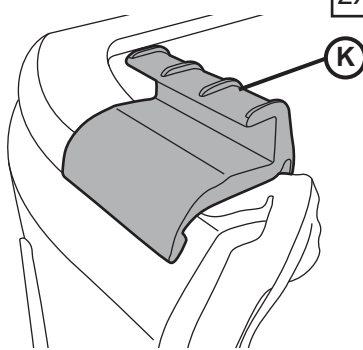

2X

Locate the left and right Tailgate Mounts. Orient them on the vehicle. Hook the bottom of one mount under the belt rail and roll it toward the inside of the vehicle until it clips into place. Repeat this with the other Tailgate Mount.

5

Driver's Side Shown

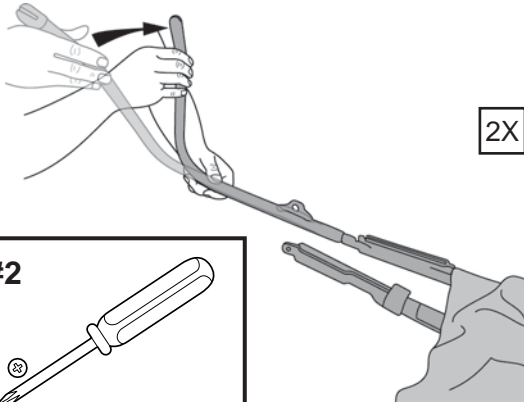
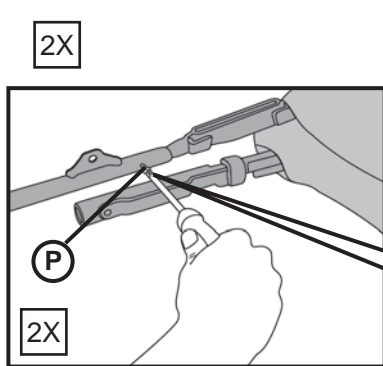

2X

2X

Rotate Side Bow 90 degrees until vertical. Insert screw into existing hole and tighten using Phillips screw driver.

P

#2

2X

2X

6

Passenger Side Shown

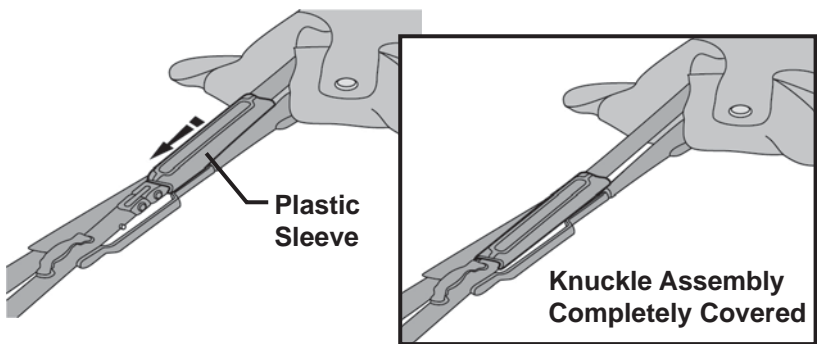

Slide plastic sleeve over knuckle assembly.

Plastic Sleeve

Knuckle Assembly Completely Covered

7

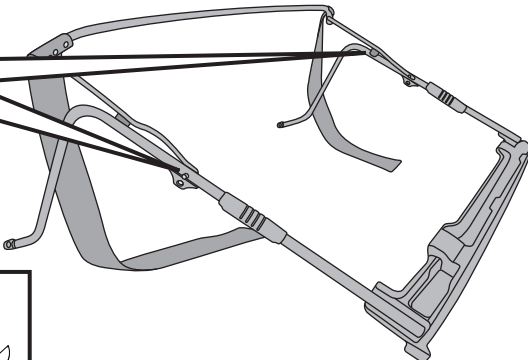
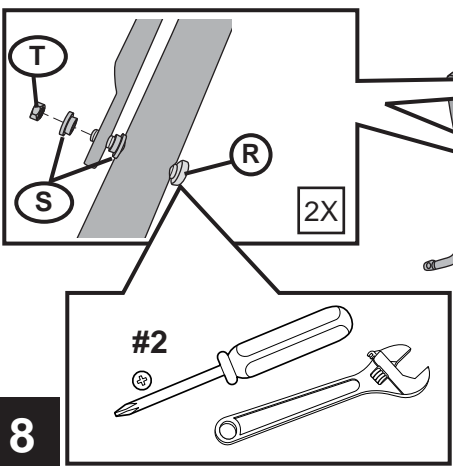

Locate the Center Bow Assembly. Align hole to the Side Bow Assembly and secure.

Use an M5 x 30 Machine Screw with two (2) Bushings and an M5 Nylock Nut.

2X

#2

2X

8

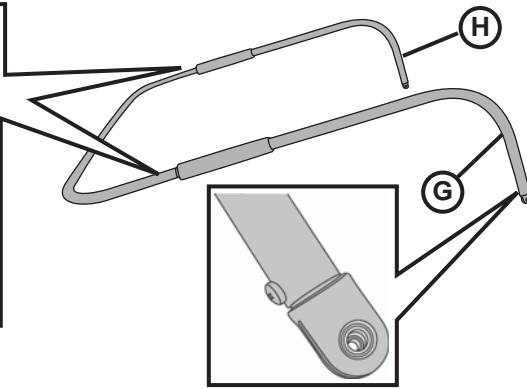
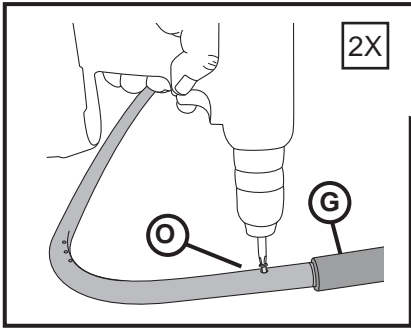

Locate the left and right Side Bows and orient them with the large holes to the outside. Mount them to the Rear Bow with a #8 x 1/2" Self Tapping Screw on each side.

9

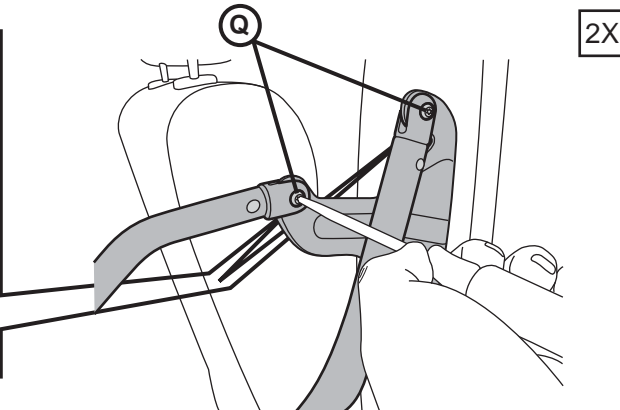
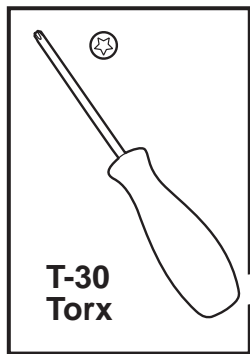

Place the Top Assembly on the vehicle. Use Pivot Knuckle Bolts to mount rear bow on Top Assembly to Bow Mount Brackets.

10

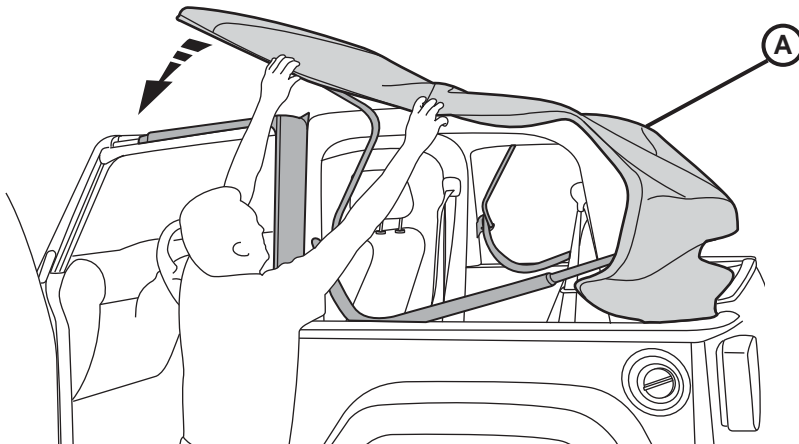

Open the Top Assembly and drape it over the cab of the vehicle.

11

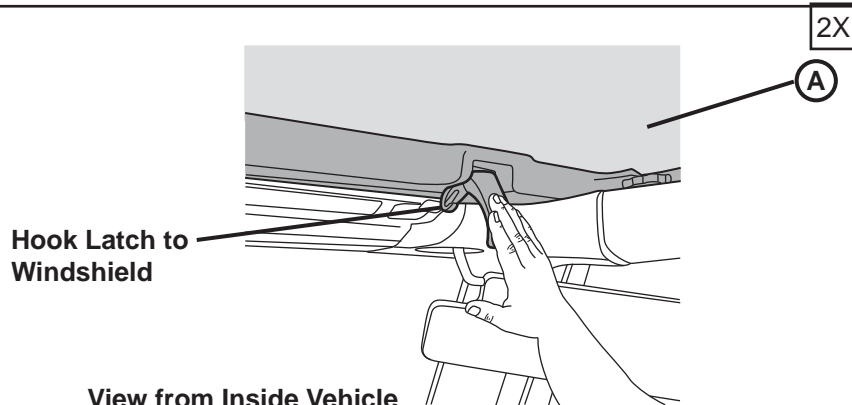

Close the front of the Top and secure the latches on the header to the windshield.

12

View from Inside Vehicle

2X

Roll Plastic
into Channel

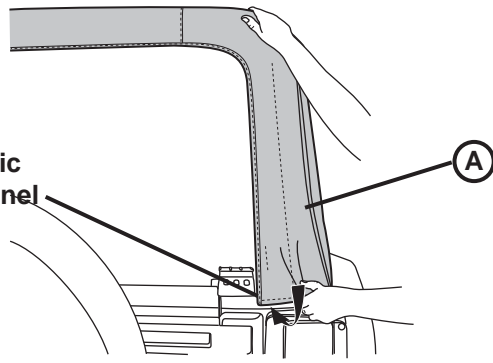

Slip the plastic strip in
the rear corners of the
Top into the channel on
the vehicle.

13

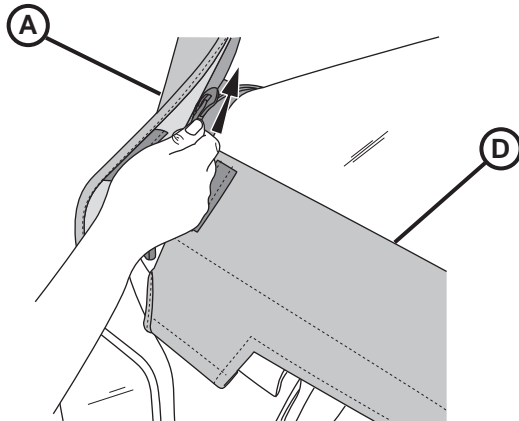

Start the zipper on the
Rear Window and close
it part of the way around.

14

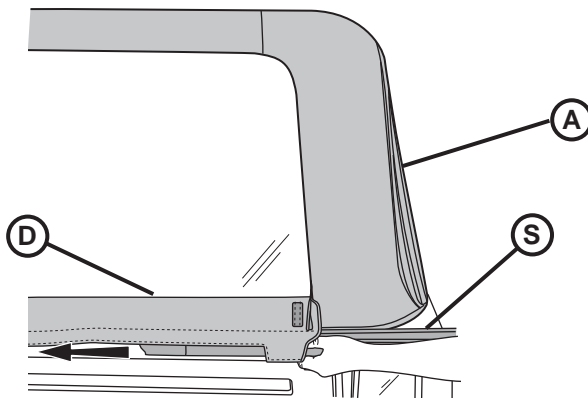

Slide the channel in the
Tailgate Bar onto the
tubing along the bottom
of the Rear Window on
the inside.

15

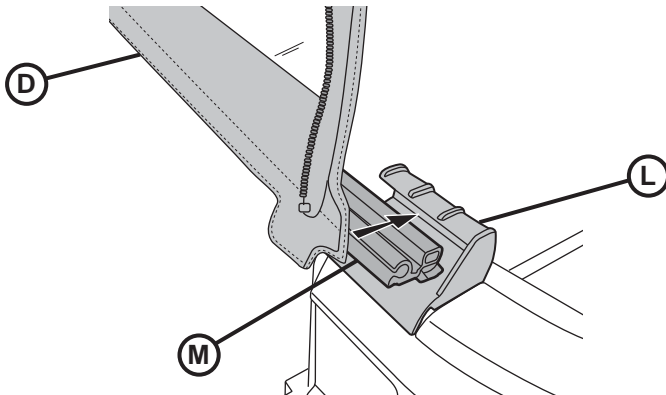

Slide the Tailgate
Bar into the Tailgate
Mounts on each side of
the tailgate opening.

16

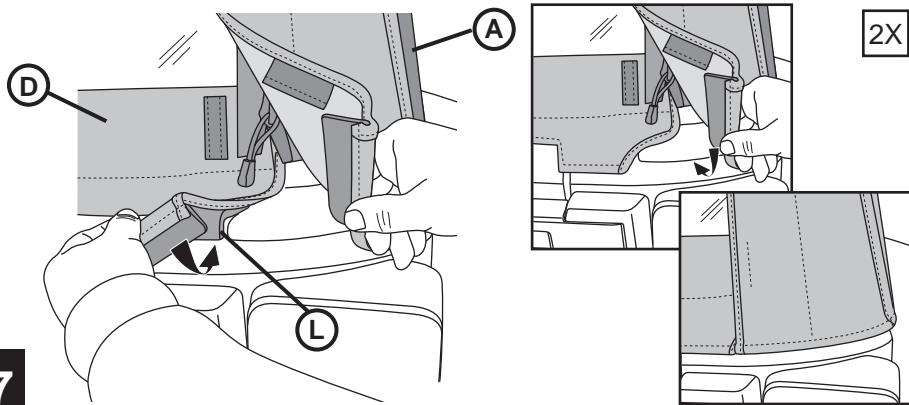

Slip the plastic strip in the Rear Window and Top into the channel on the vehicle.

17

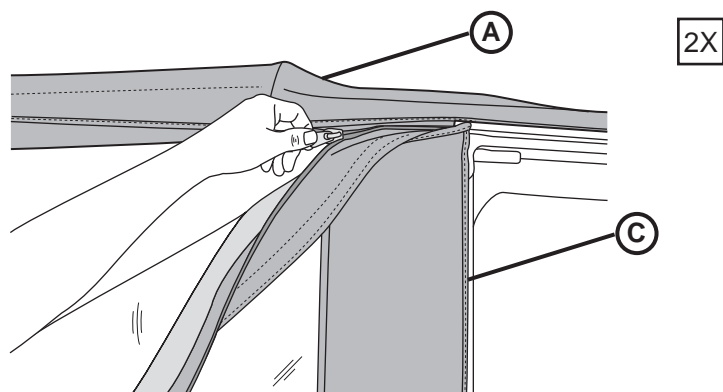

Start the zipper on the Side Window and close it 1-2 inches.

18

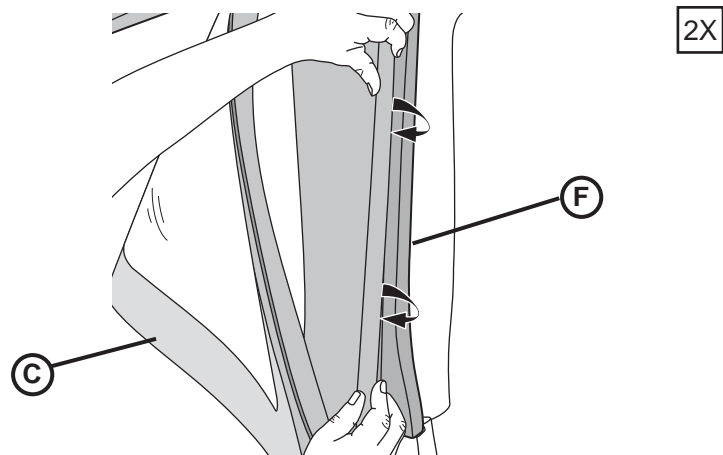

Roll the plastic strip along the front of the Side Window into the channel in the Door Surround.

19

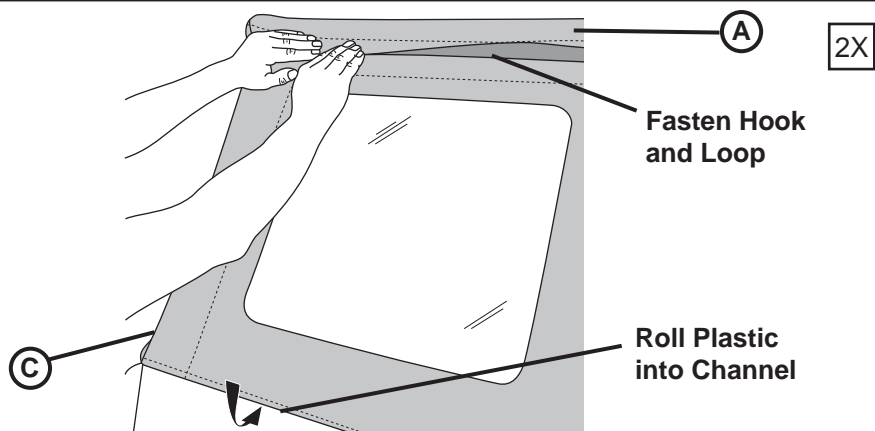

Close the zipper and slip the plastic along the bottom of the Side Window into the channel on the vehicle. Fasten the hook and loop strip above the window to the top.

20



JEEP WRANGLER

JUEGO PARA TOPE DE TECHO PARA VEHÍCULO DE DOS PUERTAS

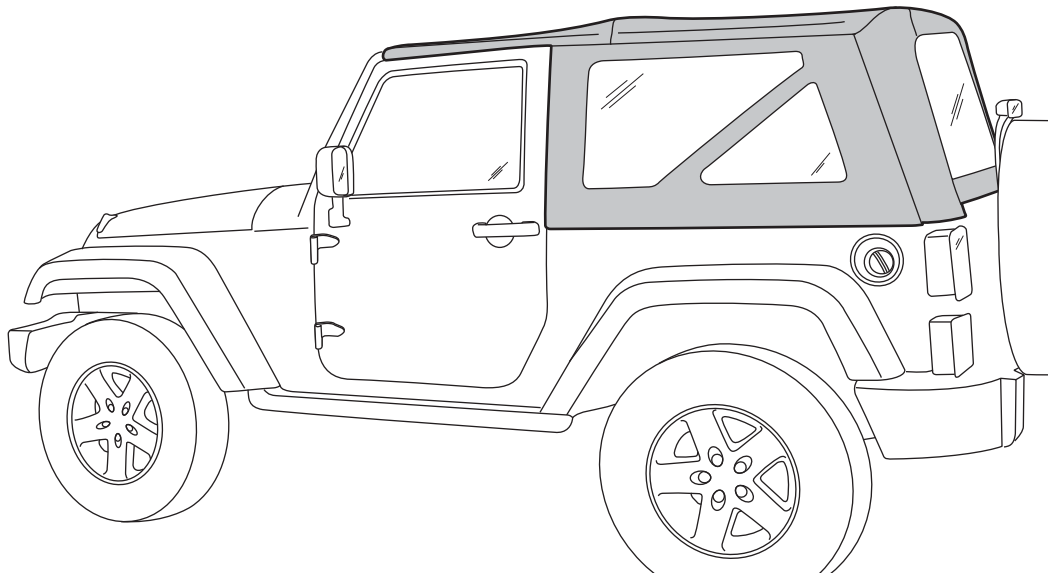

82213649
82213650

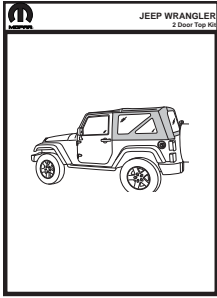

K6861727

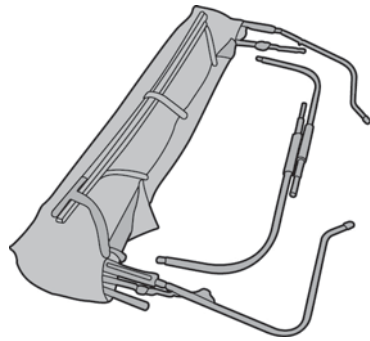

A 1X

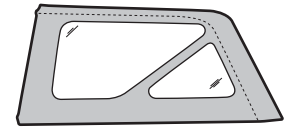

B 1X Mano izquierda

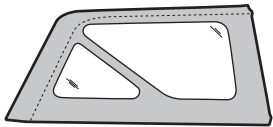

C 1X Mano derecha

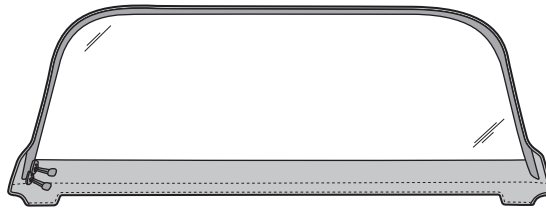

D 1X

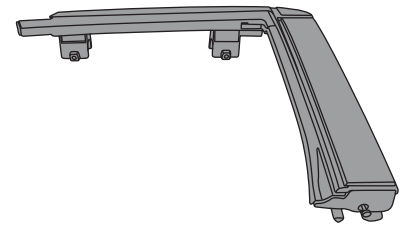

E 1X Mano izquierda

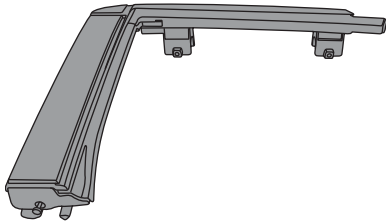

F 1X Mano derecha

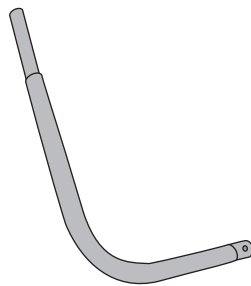

G 1X Mano izquierda

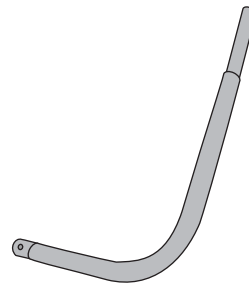

H 1X Mano derecha

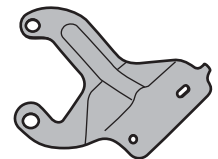

I 1X Mano izquierda

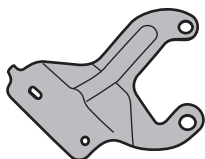

J 1X Mano derecha

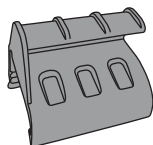

K 1X Mano izquierda

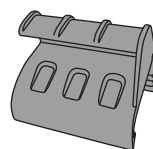

L 1X Mano derecha

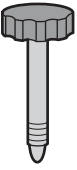
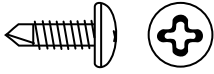
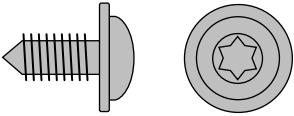
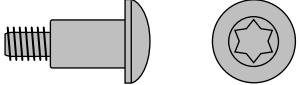
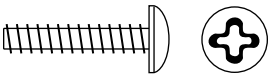
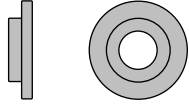
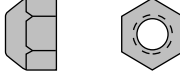
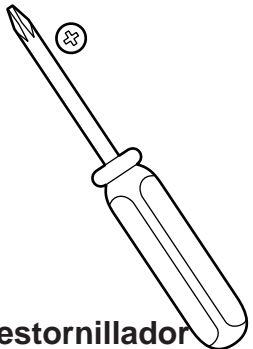
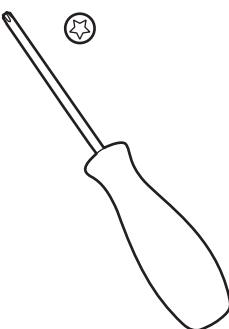
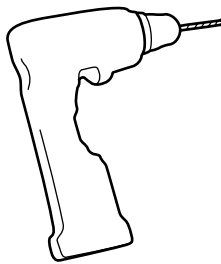
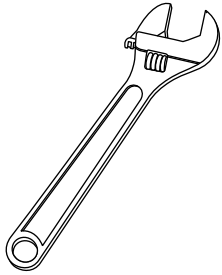
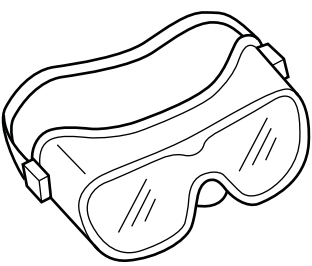

M 1X

 <p>N 4X</p>	 <p>O 2X</p>	 <p>P 4X</p>	 <p>Q 4X</p>
 <p>R 2X</p>	 <p>S 4X</p>	 <p>T 2X</p>	
 <p>Destornillador Phillips tamaños 1, 2 y 3</p>	 <p>Destornillador T-15 y T-30 Torx</p>	 <p>Taladro con punta Phillips # 2</p>	 <p>Llave ajustable</p>
			

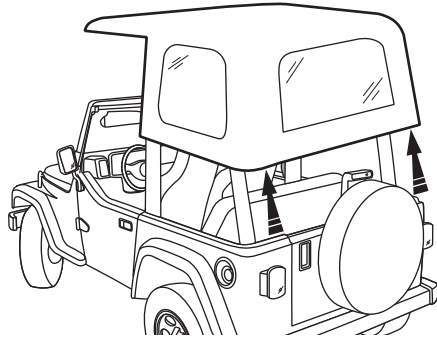
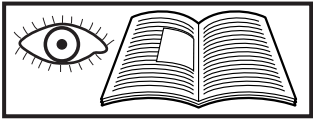

Retire el techo duro.
Remítase al manual del
propietario para las in-
strucciones.

1

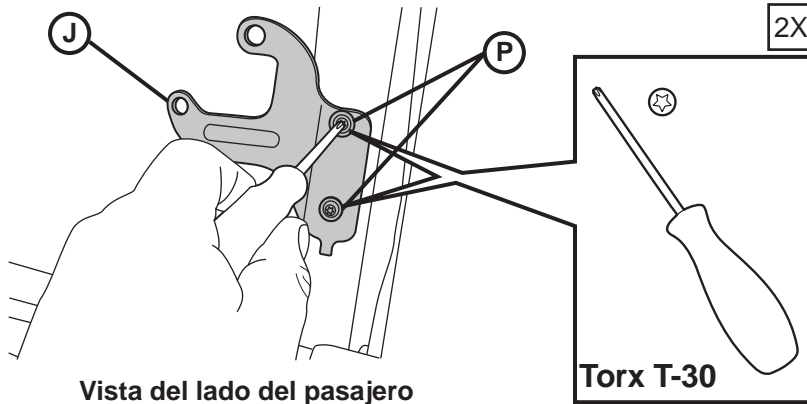

Vista del lado del pasajero

Torx T-30

Use los Tornillos para
Bisagras para instalar
las Bisagras del Basti-
dor del Armazón sobre
la barra antivuelco de la
parte trasera.

2

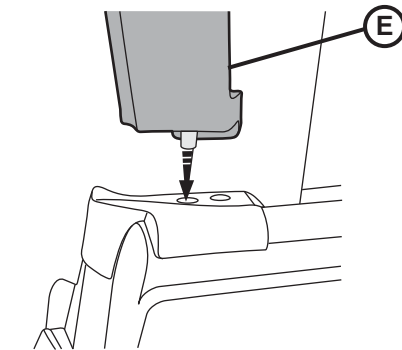

Vista del lado del conductor

Ubique los Marcos de
las Partes Superiores
de las Puertas izquierda
y derecha. Inserte el
pasador en el fondo
del Marco de la Parte
Superior de la Puerta
en el hueco del riel de
la correa detrás de la
puerta.

3

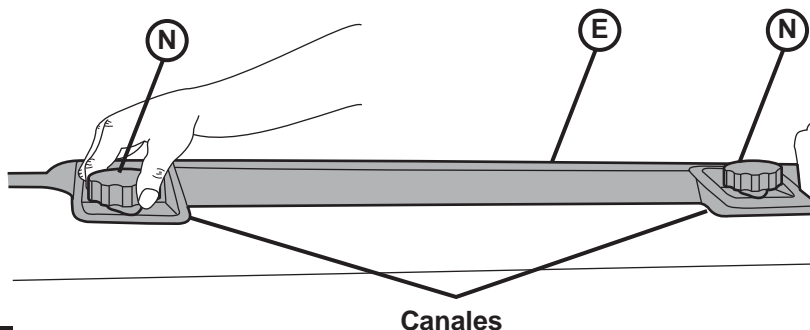

Canales

Presione los canales a lo
largo del tope del Marco
de la Parte Superior
de la Puerta alrededor
de la barra antivuelco
horizontal, arriba de la
abertura de la puerta.
Inserte las dos perillas
en el Marco de la Parte
Superior de la Puerta y
apriételas.

4

Vista desde el interior por encima del lado del conductor.

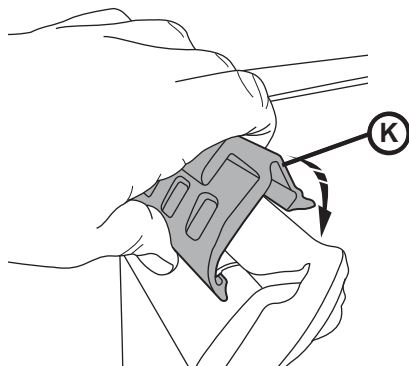

Vista desde lado del conductor

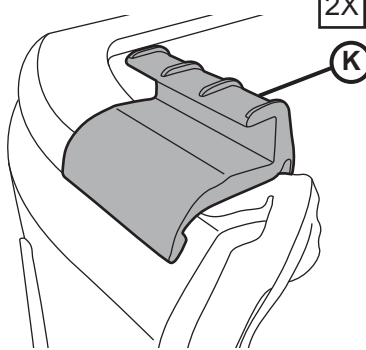

Ubique el bastidor izquierdo y derecho de la Compuerta Trasera. Diríjalos hacia el vehículo. Enganche la parte inferior de uno de los bastidores debajo del riel de la correa y enróllelo hacia el interior del vehículo hasta que el gancho lo agarre. Repita con el otro Bastidor de la Compuerta Trasera.

5

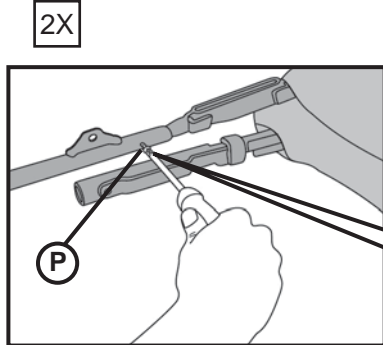

Vista del lado del pasajero

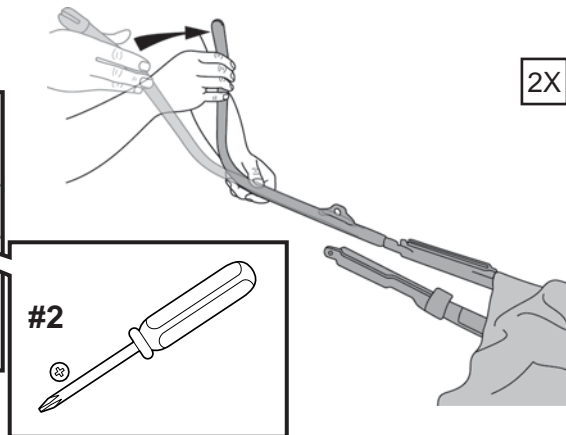

Gire el arco lateral 90 grados hasta colocarlo en posición vertical. Introduzca el tornillo en el agujero correspondiente y apriételo con un destornillador de cruz.

6

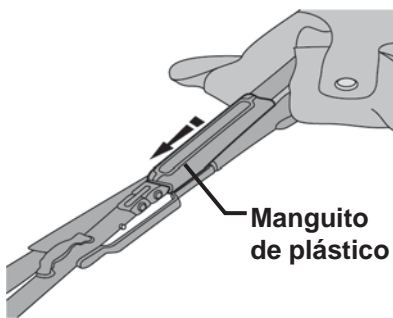

Manguito de plástico

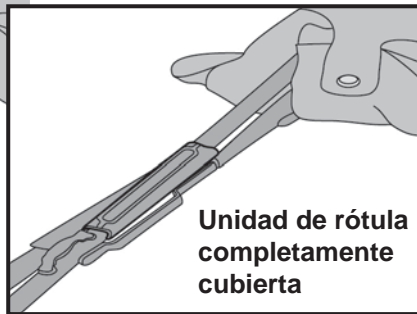

Unidad de rótula completamente cubierta

Deslice el manguito de plástico sobre la unidad de rótula

7

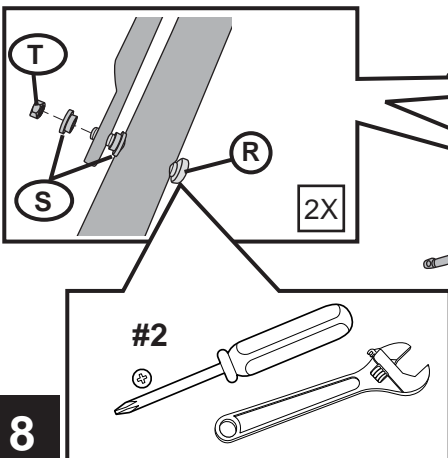

#2

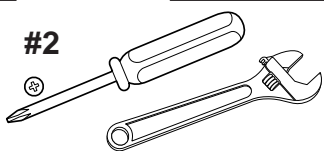

2X

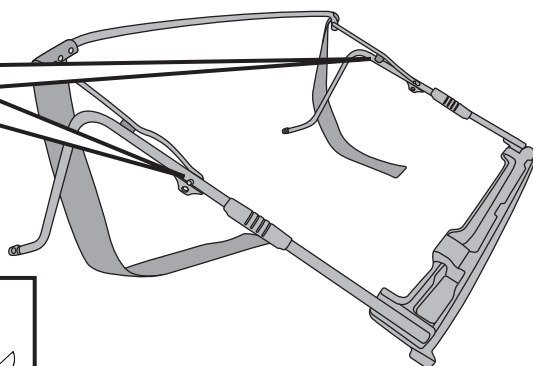

Localice la unidad del arco central. Alinee el agujero con la unidad del arco lateral y asegúrela.

Use un tornillo para metales M5 x 30 con dos (2) cojinetes y una tuerca de Nylock M5.

8

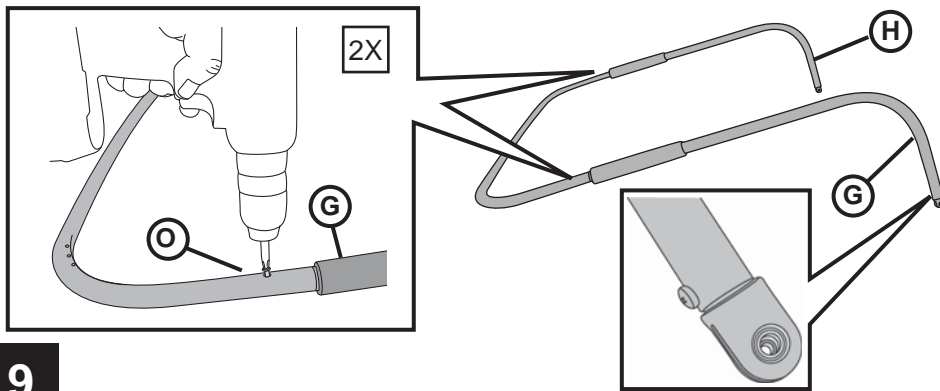

Localisez les arceaux latéraux gauche et droite et orientez-les de manière à ce que les grands trous soient vers l'extérieur.

Fixez-les sur l'arceau arrière à l'aide d'une vis autotaraudeuse n° 8 x 1/2 po de chaque côté.

9

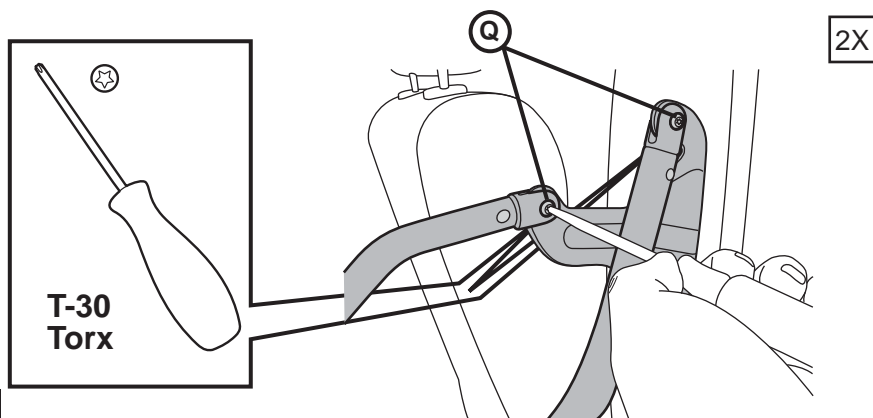

Coloque la Estructura del Techo sobre el vehículo. Utilice los Pernos de Fijación de las Bisagras para fijar el armazón trasero en la Estructura del Techo a las Bisagras de los Bastidores.

10

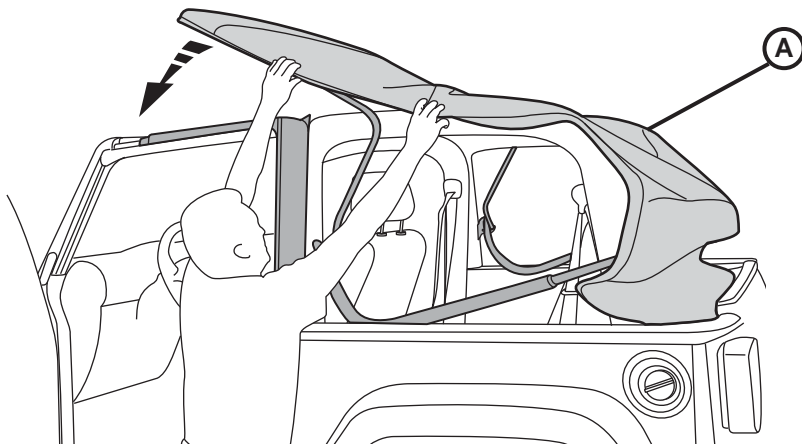

Saque la Estructura del Techo y córrala sobre la cabina del vehículo.

11

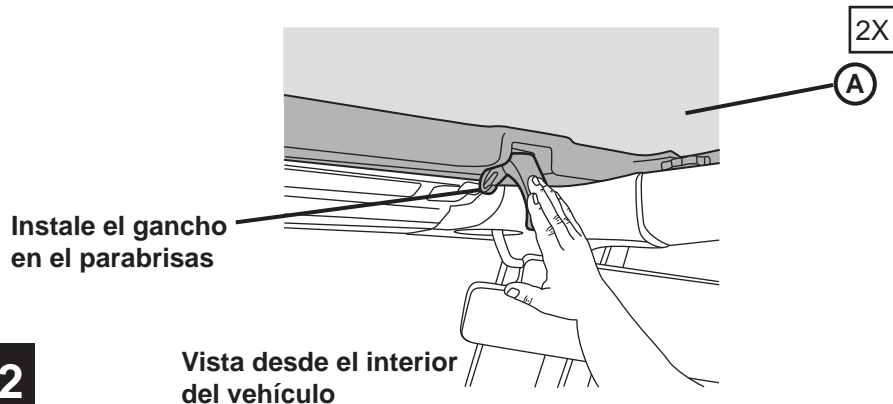

Instale el gancho en el parabrisas

Vista desde el interior del vehículo

Cierre la parte frontal del Techo y asegúrelo al parabrisas con los ganchos en la cabecera.

12

2X

Enrolle el plástico adentro del canal

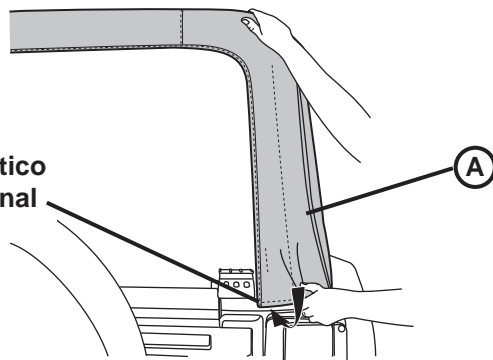

Deslice las tiras plásticas ubicadas en las esquinas traseras del Techo adentro del canal tubular en el vehículo.

13

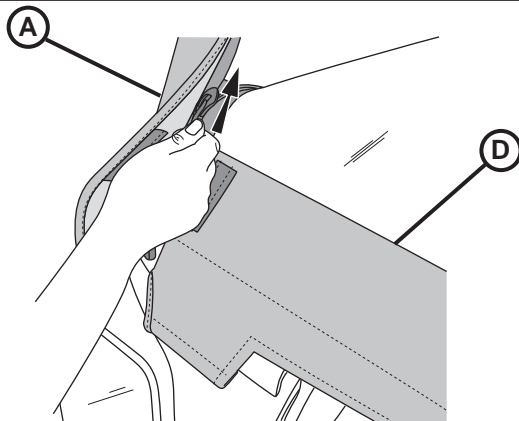

Proceda a cerrar la cremallera en la Ventana Trasera y cierre parte de ese marco.

14

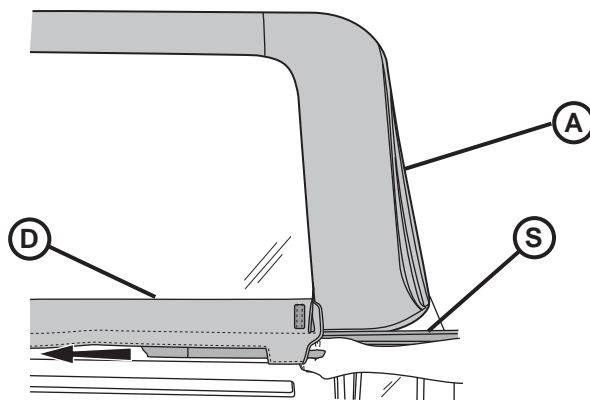

Deslice el canal tubular en la Barra de la Compuerta Trasera sobre el tubular ubicado a lo largo del fondo de la parte de adentro de la Ventana Trasera.

15

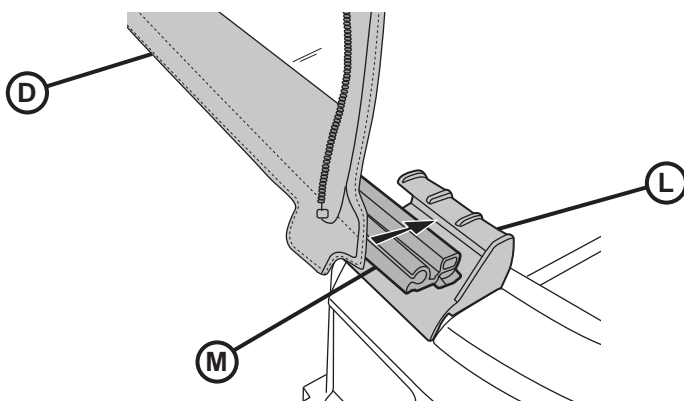

Deslice la Barra de la Compuerta Trasera adentro de los Bastidores de la Compuerta Trasera a cada lado de la abertura de la compuerta trasera.

16

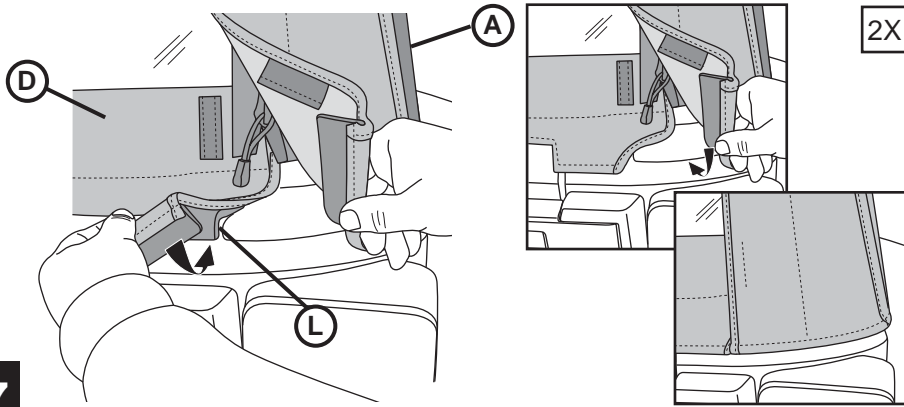

17

Deslice las tiras plásticas ubicadas en las esquinas traseras del Techo adentro del canal tubular en el vehículo.

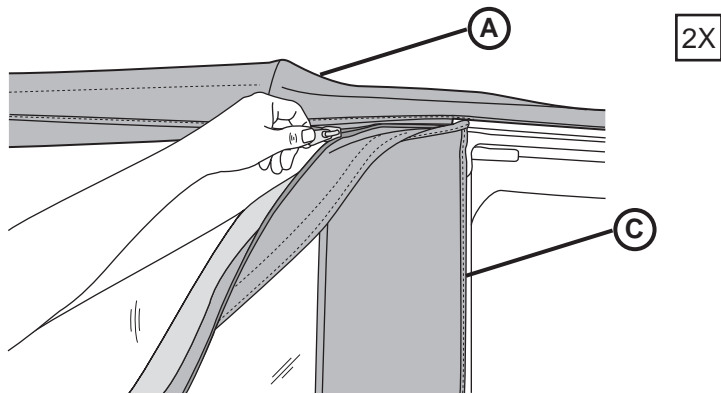

18

Proceda a cerrar la cremallera ubicada en la Ventana Lateral y ciérrela sólo en 1 ó 2 pulgadas.

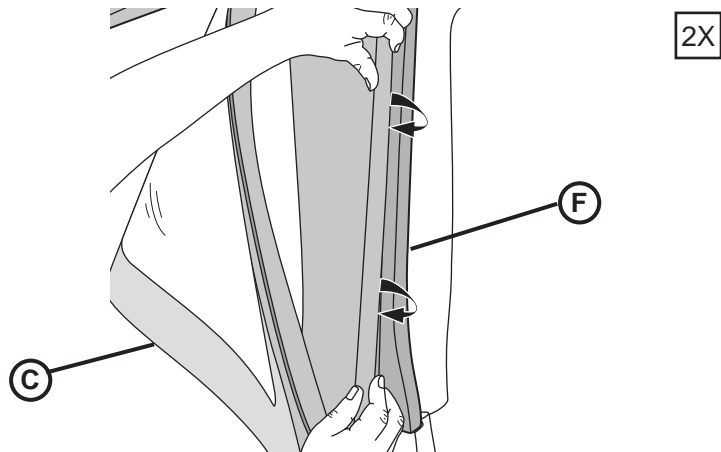

19

Enrolle la tira plástica ubicada a lo largo de la parte frontal de la Ventana Lateral adentro del canal en el Marco de la Parte Superior de la Puerta.

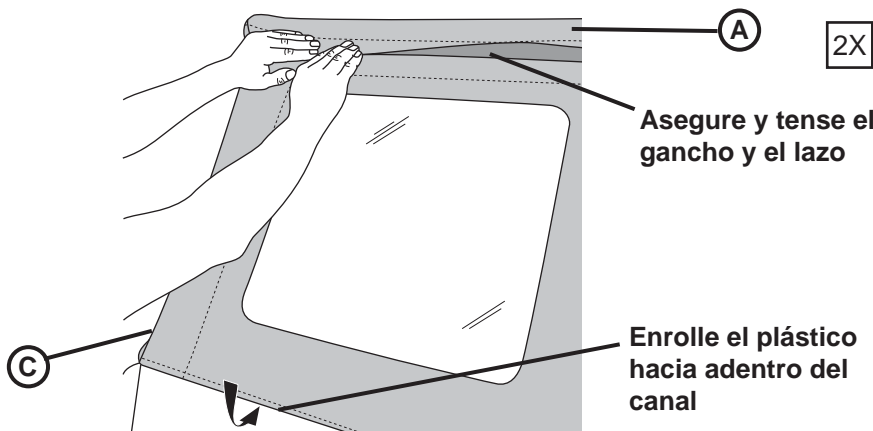

20

Cierre la cremallera y deslice el plástico a lo largo del fondo de la Ventana Lateral adentro del canal tubular en el vehículo. Asegure y tense el gancho y el lazo que están sobre ventana al techo.



JEEP WRANGLER

KIT DE TOIT AMOVIBLE POUR MODÈLE 2 PORTES

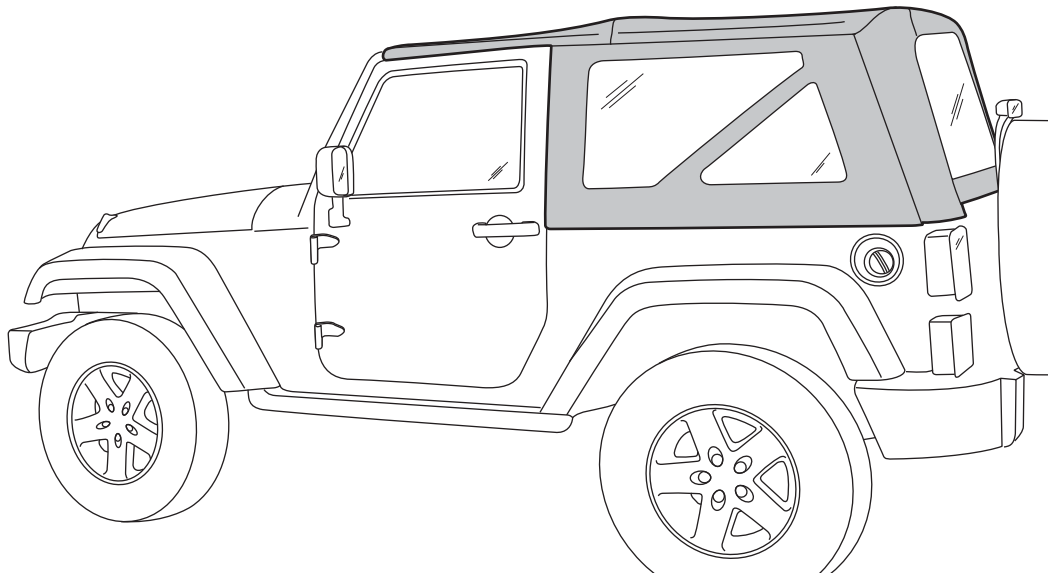

82213649
82213650

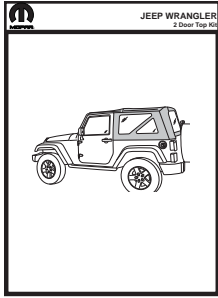

K6861727

A 1X

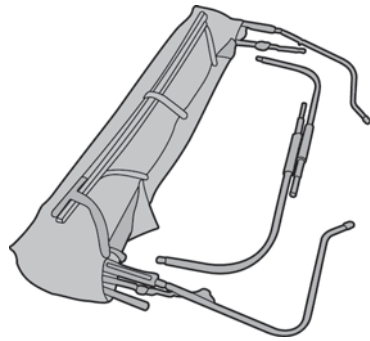

B 1X G

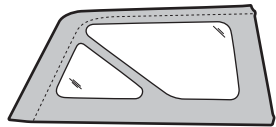
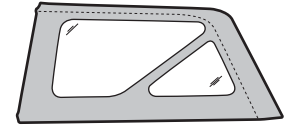

C 1X D

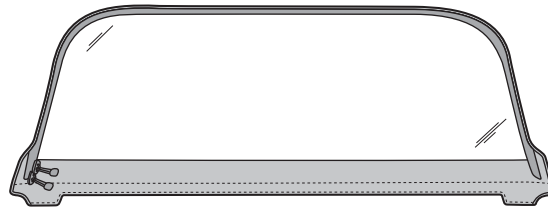

D 1X

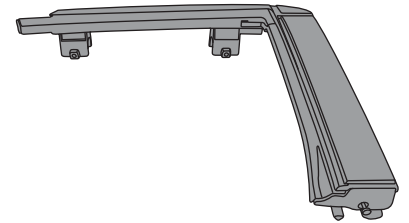

E 1X G

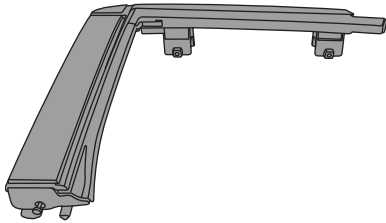

F 1X D

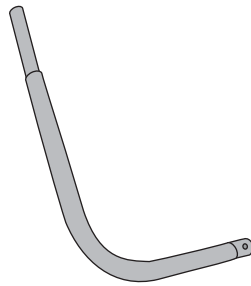

G 1X G

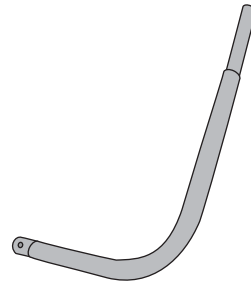

H 1X D

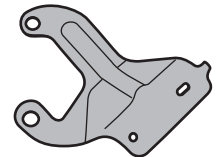

I 1X G

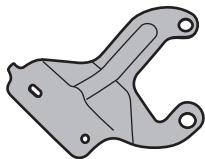

J 1X D

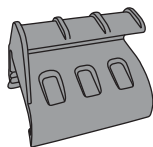

K 1X G

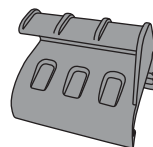

L 1X D

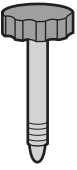
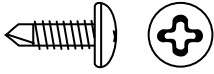
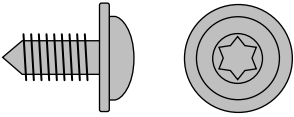
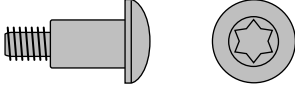
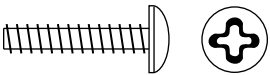
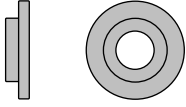
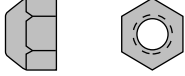
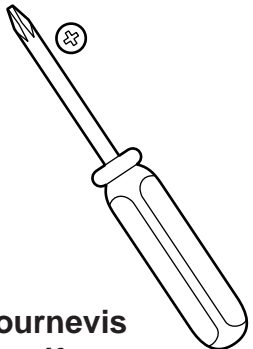
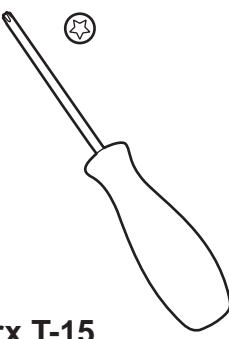
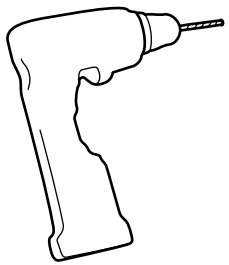
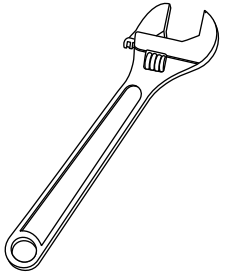
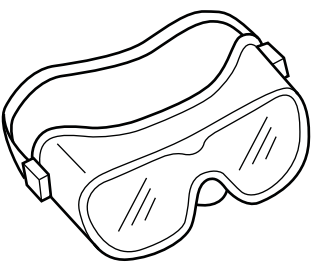

M 1X

 <p>N 4X</p>	 <p>O 2X</p>	 <p>P 4X</p>	 <p>Q 4X</p>
 <p>R 2X</p>	 <p>S 4X</p>	 <p>T 2X</p>	
 <p>Tournevis cruciforme Tailles 1, 2 et 3</p>	 <p>Torx T-15 et T-30</p>	 <p>Perceuse Foret cruciforme n° 2</p>	 <p>Clé à molette</p>
			

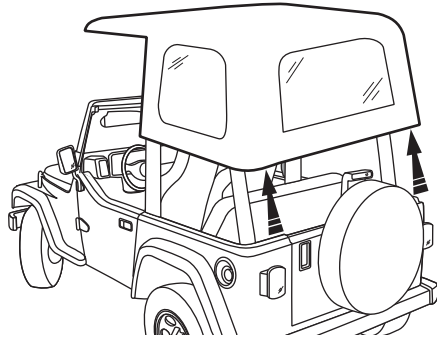

Retirez le toit amovible.
Reportez-vous au guide
d'utilisation pour les
instructions.

1

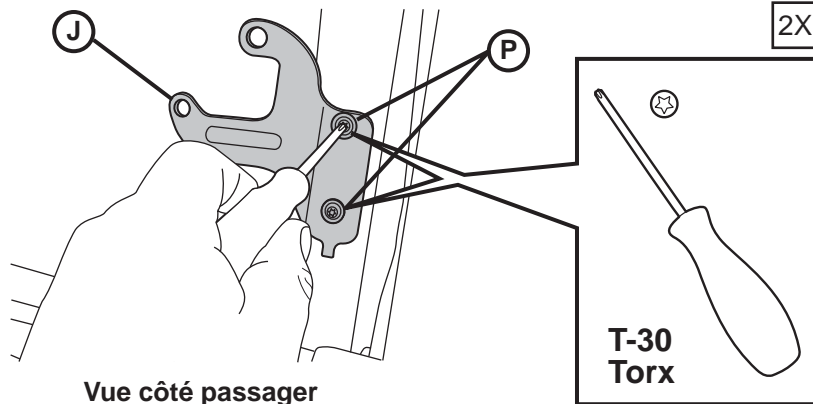

Utilisez les vis de sup-
port pour installer les
supports de fixation
pour arceau sur la barre
sport arrière.

2

Vue côté passager

T-30
Torx

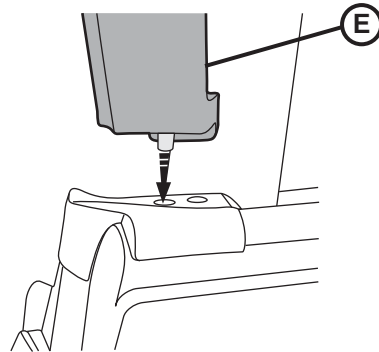

Localisez les
encadrements de
porte gauche et droite.
Insérez la tige du bas
de l'encadrement de
porte dans le trou du rail
d'arrimage derrière la
porte.

3

Vue côté conducteur

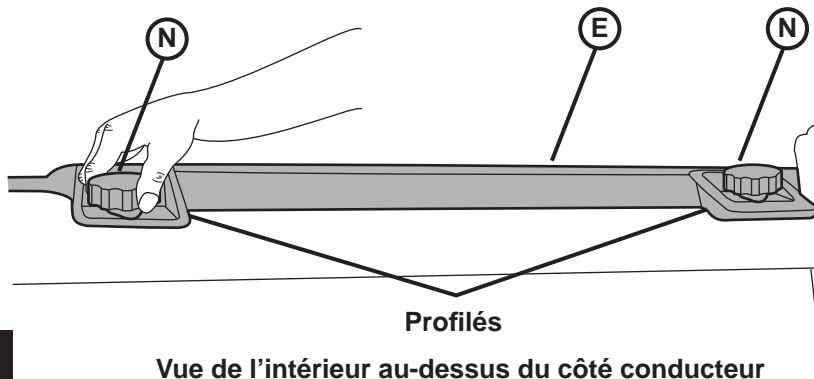

Appuyez les profilés
sur le dessus de
l'encadrement de porte
autour de la barre
sport horizontale, au-
dessus de l'ouverture
de la porte. Insérez
les boutons dans
l'encadrement de porte
et serrez-les en place.

4

Vue de l'intérieur au-dessus du côté conducteur

Profilés

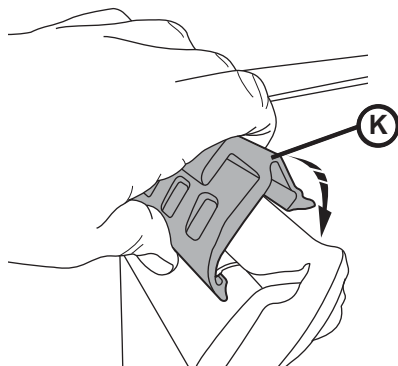

2X

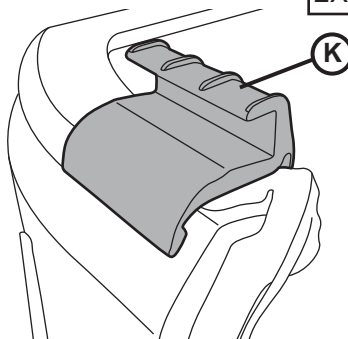

5

Vue côté conducteur

Localisez les montures pour hayon gauche et droite. Orientez-les sur le véhicule. Accrochez le bas de l'une des montures sous le rail d'arrimage et tournez-la vers l'intérieur du véhicule jusqu'à ce qu'elle s'enclenche en place. Répétez cette étape avec l'autre monture pour hayon.

2X

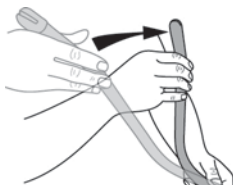
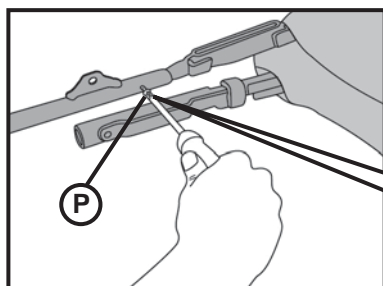

2X

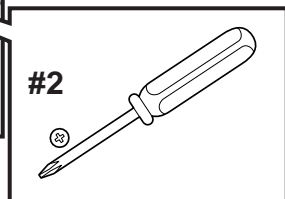

6

Vue côté passager

Faire tourner l'arceau latéral de 90 degrés jusqu'à ce qu'il soit vertical. Insérer la vis dans le trou existant et serrer à l'aide d'un tournevis à pointe cruciforme.

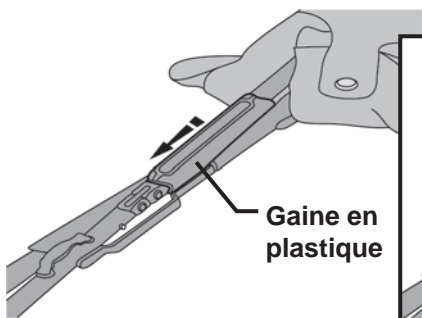

2X

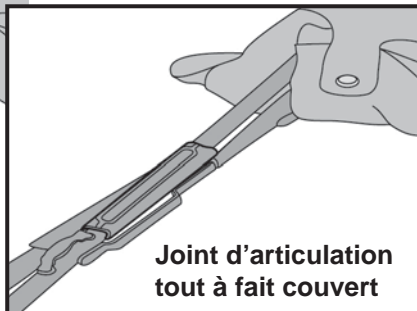

7

Faites glissez la gaine en plastique autour du joint d'articulation.

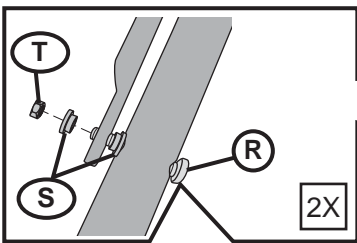

2X

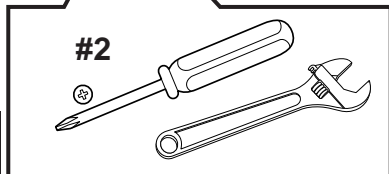

8

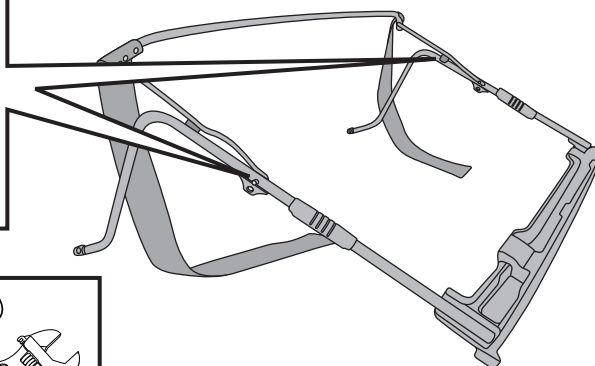

Localiser l'arceau central. Placer le trou vis-à-vis de l'arceau latéral et fixer.

Utiliser une vis mécanique M5 x 30 à l'aide de deux (2) douilles et un écrou à frein élastique M5.

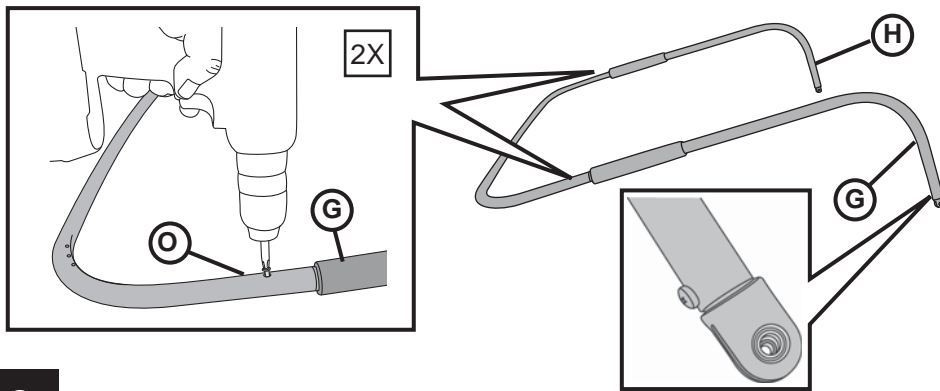

Localisez les arceaux latéraux gauche et droite et orientez-les de manière à ce que les grands trous soient vers l'extérieur.

Fixez-les sur l'arceau arrière à l'aide d'une vis autotaraudeuse n° 8 x 1/2 po de chaque côté.

9

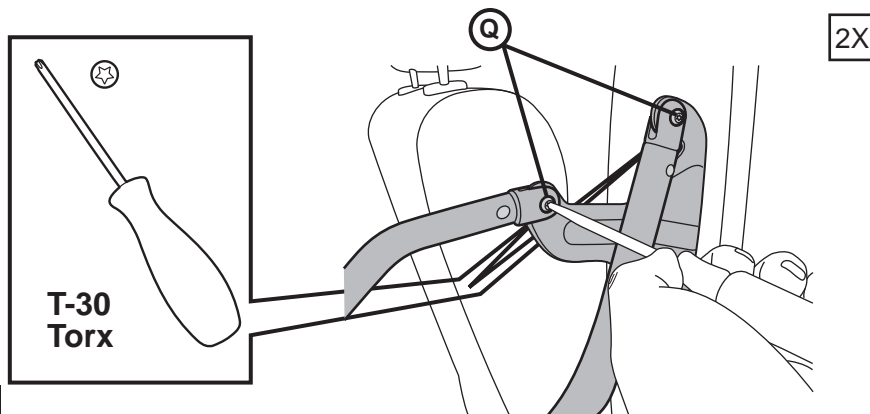

Placez le toit sur le véhicule.

Utilisez des boulons à rotule pivotants pour fixer l'arceau arrière du toit sur les supports de fixation pour arceau.

10

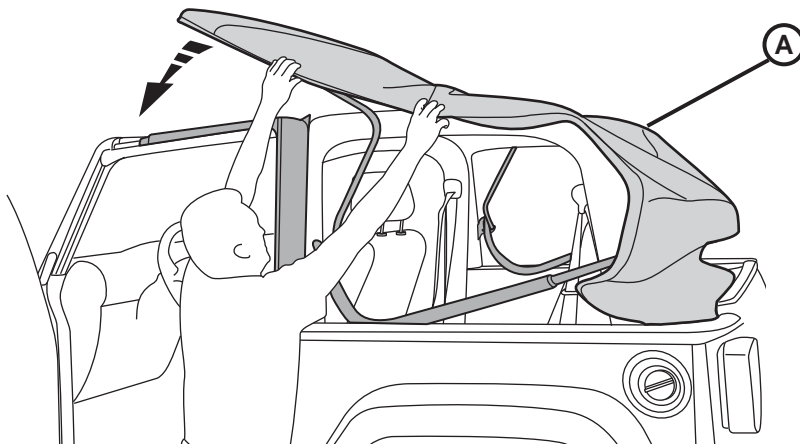

Ouvrez le toit et recouvrez-en la cabine du véhicule.

11

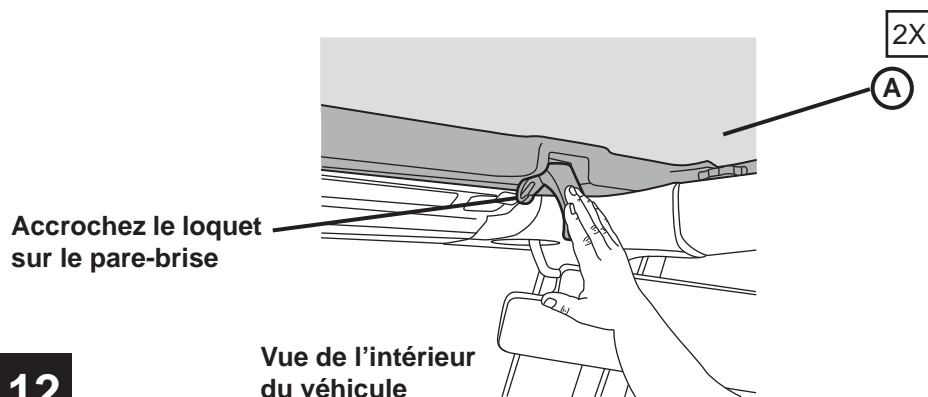

Accrochez le loquet sur le pare-brise

Vue de l'intérieur du véhicule

Fermez l'avant du toit et fixez les loquets du toit sur le pare-brise.

12

2X

Enroulez le plastique dans le profilé

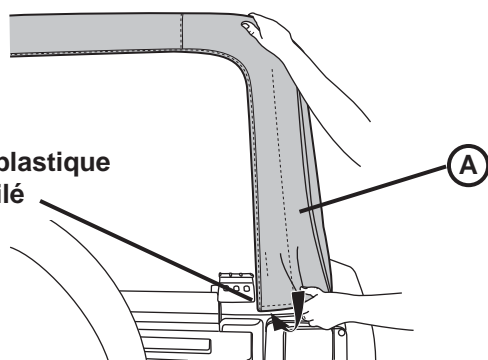

Insérez la languette de plastique dans les coins arrière du toit dans le profilé du véhicule.

13

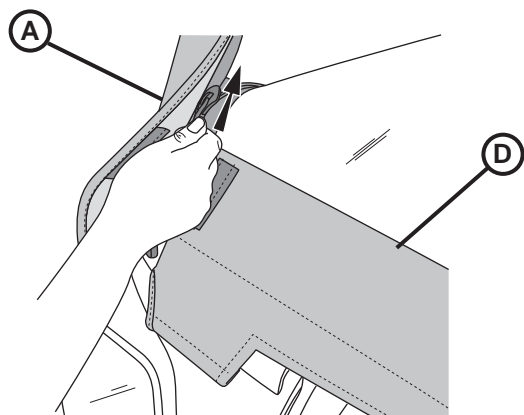

Tirez sur la fermeture à glissière de la fenêtre arrière et fermez-la partiellement sur le pourtour.

14

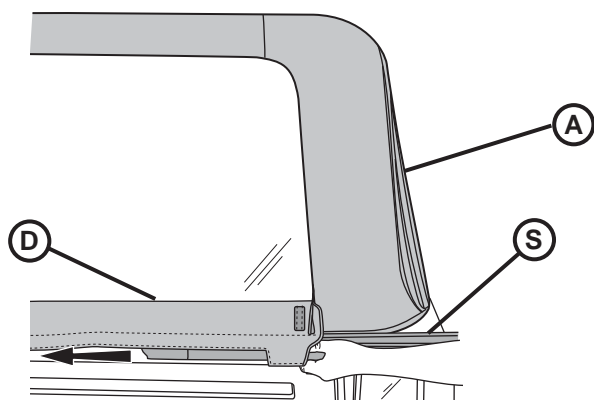

Faites glisser le profilé de la barre de hayon sur la tubulure autour du bas de la fenêtre arrière à l'intérieur.

15

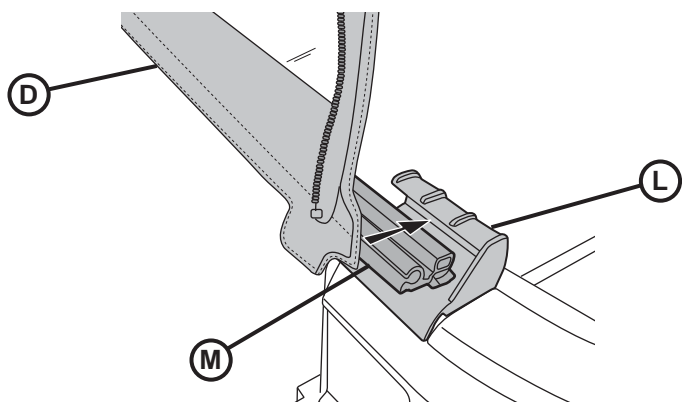

Faites glisser la barre de hayon dans les montures pour hayon de chaque côté de l'ouverture du hayon.

16

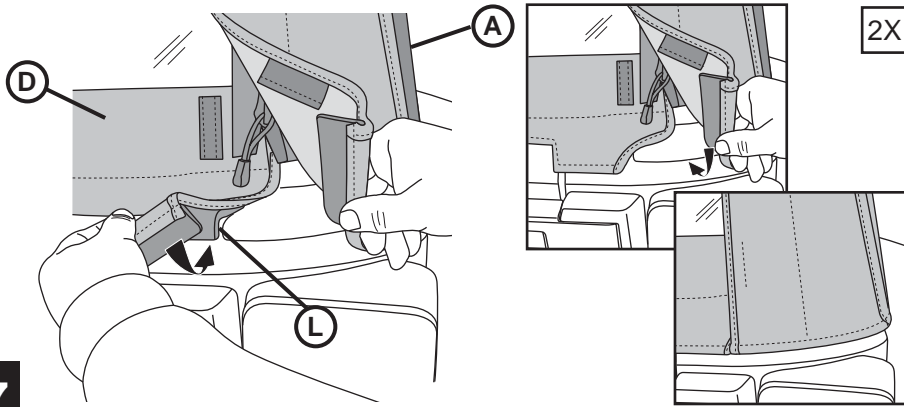

Insérez la languette de plastique dans les coins arrière du toit dans le profilé du véhicule.

17

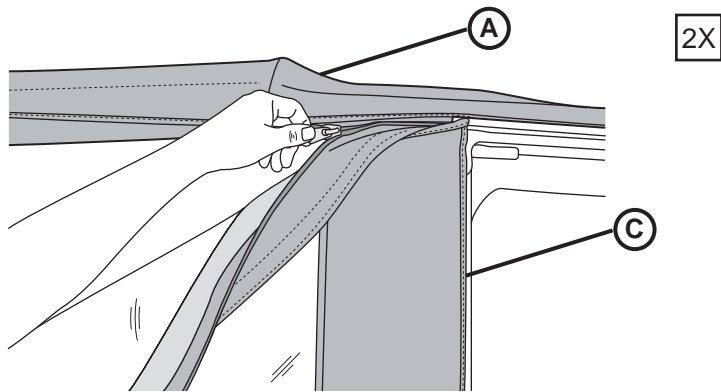

Tirez sur la fermeture à glissière de la fenêtre latérale et fermez-la sur 2,5 à 5 cm (1 à 2 pouces).

18

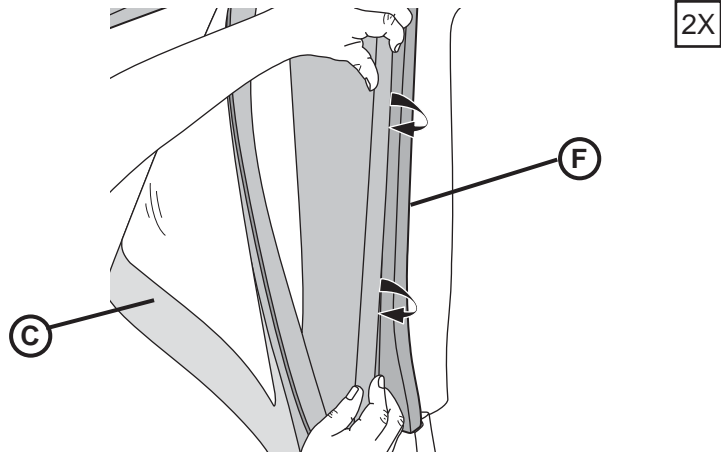

Enroulez la languette de plastique le long de l'avant de la fenêtre latérale dans le profilé de l'encadrement de porte.

19

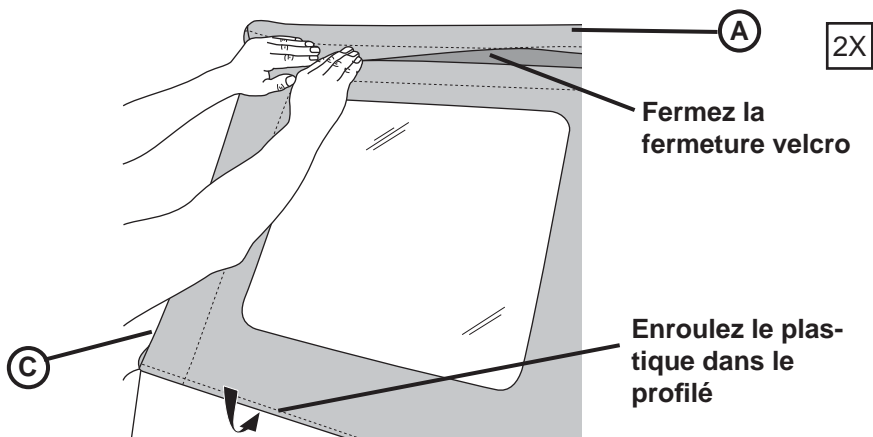

Fermez la fermeture à glissière et faites glisser le plastique le long du bas de la fenêtre latérale dans le profilé du véhicule. Fixez la fermeture velcro au-dessus de la fenêtre sur le toit.

20