



# ALUMINUM CARBURETORS

***SPEED  
DEMON™***

***ROAD  
DEMON™***

INSTRUCTION MANUAL  
LIT733

[www.demoncarbs.com](http://www.demoncarbs.com)

## INTRODUCTION

Demon Carburetors™ have many unique features that make them the ultimate choice for performance enthusiasts, like yourself. This manual will discuss the special points and unique features of the Demon carburetors, and the correct procedures for their proper installation and tuning. The goal is to help you understand the thoughts behind the Demon, and to increase your knowledge of carburetion on a whole. Please read and understand this manual completely to assure that you get the most out of your new Demon carburetor.

**Please be advised that design changes have been made to this carburetor. The fuel inlet spread dimension has been changed to 9 ½" center to center. Your existing fuel connections may have to be modified or replaced.**



Figure 1

## INSTALLATION

### Checking the Baseline Adjustments

All baseline adjustments have been made at the factory during the final assembly stage of each carburetor. These settings should allow initial start and warm up of the engine. However, in order to assure safe operation, and to assist with fine tuning that will occur later, please check and make note of the following adjustments, prior to installing the carburetor on the engine.

### Throttle and Accelerator Pump Linkage

1. Check the travel of the throttle linkage to be sure no damage has occurred during handling or shipping after its final assembly. The carburetor should open smoothly to wide open throttle, and return to its full closed position when the linkage is released. At wide open throttle, all throttle plates should be parallel to each other, at about a 90° right angle to the baseplate gasket surface. Do not attempt to run a carburetor that opens the secondaries past full throttle, or sticks or binds at any point in its travel.
2. When the carburetor is in the closed (curb idle) position, there should be no play in the adjustment of the accelerator pump arms. The pump levers should begin compressing the pump diaphragms as soon as the linkage begins to move. Play in the pump arm linkage will delay the fuel discharge, and the result is usually a stumble or hesitation as the carburetor begins to open. At wide open throttle, check to be sure that .015" to .020" travel remains in the accelerator pump linkage. If the pump diaphragms bottom out, premature wear or binding in the linkage will occur.

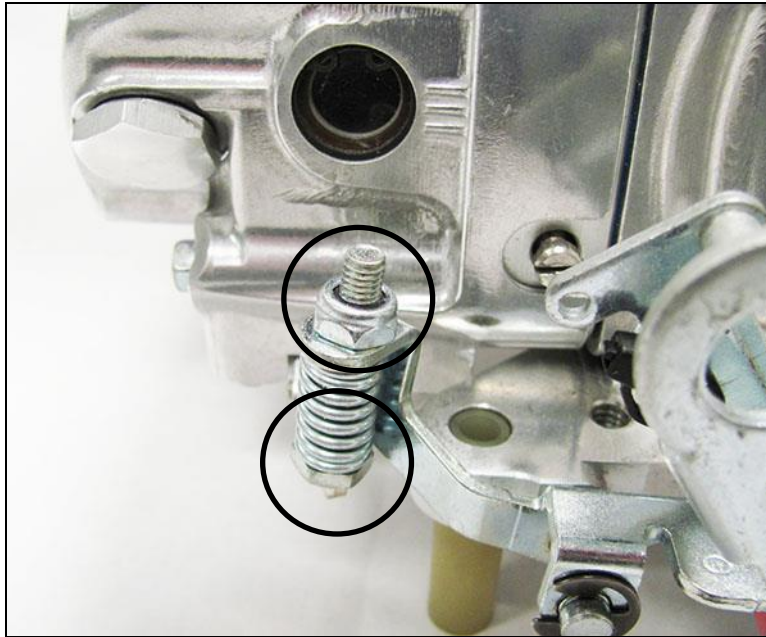

**Figure 2**

3. Slop in the linkage can be adjusted out by either tightening or loosening the lock nut. This is done by using a wrench at the bottom to hold it tight and turning the top nut to tighten or loosen (**Figure 2**). This will control the length of the compressed spring. Slightly bend the cam follower to adjust for linkage that bottoms out. Remember, it may take a balance of both cam follower and spring adjustments to get the system working best for the application. Different cam profiles are available which can alter the timing, volume, and duration of the pump shot. If pump cams are changed, it may be necessary to re-adjust the linkage.

**NOTE:** Pump must never bottom out – minimum clearance 0.15”.

### **Closed Throttle Plate Position**

The initial setting of the closed throttle plate position will vary slightly between carburetor model sizes and fuel types. Most gasoline carburetors will have the throttle plates adjusted with a small length (approximately .020", looking like a square) of the idle transfer fuel slot visible below the bottom edge of the throttle plates (**Figure 3**).

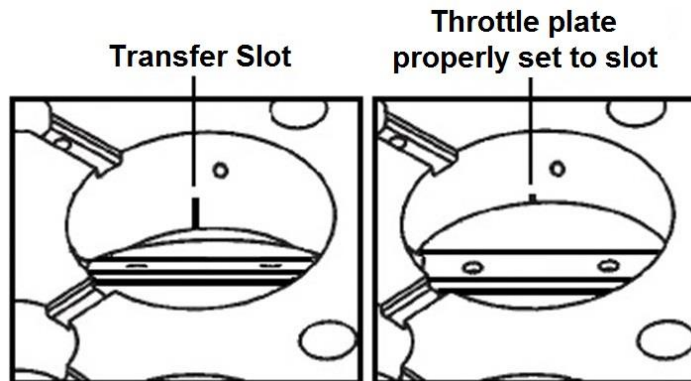

**Figure 3**

Primary and secondary throttle plates should be open equal amounts, and never seated tightly against the throttle bores in the baseplate. Throttle plate position is adjusted using the idle set screws (**Figure 4a & 4b**) in the baseplate. Turn the screws clockwise to open the throttle plates, or counterclockwise to close them down. Be sure to note the adjusted position of your model carburetor, as this can be important information used later during fine tuning.

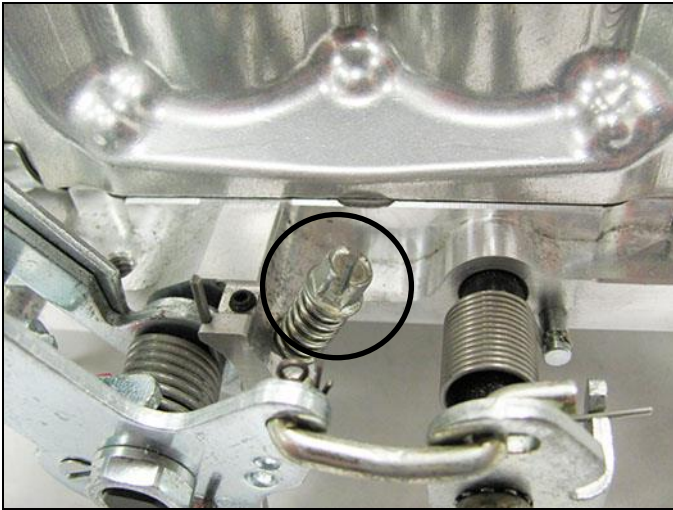

Figure 4a

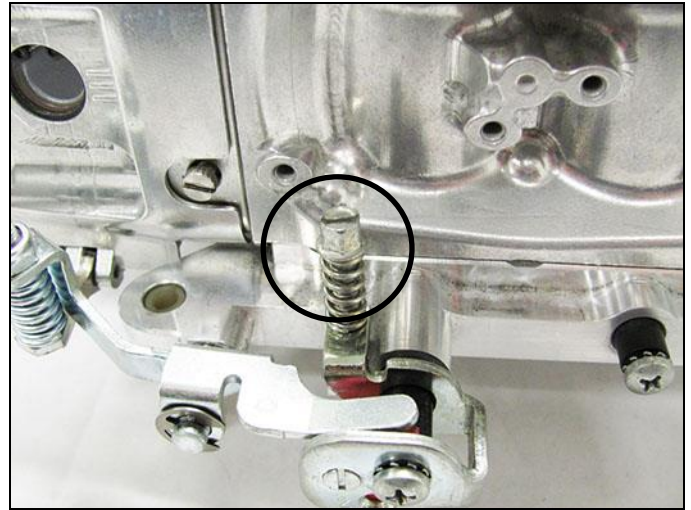

Figure 4b

## Curb Idle Mixture Screws

The curb idle mixture screws (total of 4) are located on each side of the metering block (**Figure 5a & 5b**). These screws control the amount of idle fuel mixture that will be discharged into the plenum from the curb idle ports located in the baseplate. These screws have been set during wet-flow testing at the factory and it is recommended that they remain in place as delivered for initial start-up.

Keep in mind that these settings are only a starting point, and that additional fine tuning may be required once the engine has warmed up to operating temperature.

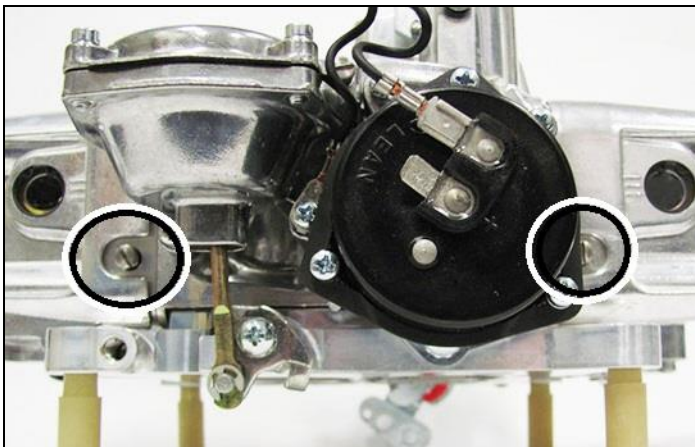

Figure 5a



Figure 5b

## Bolting the Carburetor to the Manifold

After the linkage and baseline settings have been checked, the carburetor is ready to be bolted to the manifold. Be sure to use the supplied gasket. The carburetor should slide easily over the studs. Do not force the carburetor if it hangs on the studs. If the carburetor does hang up, check for bent or improperly installed studs. Replace the studs if necessary. Once the carburetor is seated against the gasket, check to see that it sits squarely on the mounting flange.

The carburetor should not be able to be rocked diagonally. A carburetor that rocks is an indication that the manifold or carburetor spacer could be warped. This must be corrected before the carburetor is bolted down. When the carburetor sits squarely, it is safe to install nuts and washers. Be sure all nuts are installed on the studs and hand tight before beginning the final torque sequence. Use a criss-cross pattern, to tighten each nut a little at a time (**Figure 6**). Do not over tighten the nuts. Only 5-7 foot pounds of torque are required to secure

and seal the carburetor base to the manifold. Once the nuts are evenly torqued, check the carburetor linkage for smooth operation to wide open throttle, and then closed again.

**WARNING:** Baseplates that are cracked during installation are not covered under warranty.



*A socket or standard open-end wrench must be used to tighten the carburetor to the manifold.*

**Figure 6**

## Connecting the Throttle Linkage

**NOTE:** Before connecting the linkage, operate the throttle lever to assure the correct travel (no sticking or binding), by opening to wide-open throttle and back to closed throttle several times. Correct any sticking or binding conditions before proceeding.

**NOTE:** If installing on a GM vehicle where the throttle cable needs to utilize the large hole in the top of the throttle lever, a part # 1952 GM throttle linkage cable attachment bracket will be needed.

With the pedal held firmly against a stop or the floorboard, pull the carburetor to its wide open position. Adjust the linkage rod or cable to the proper length, and then attach it to the baseplate linkage. Remember, the pedal should make contact with a positive stop, just as the carburetor gets to wide open throttle. With the linkage rod or cable attached to the baseplate, make sure the carburetor can return to its curb idle position. Install your return spring(s) to the bottom of the throttle lever as shown in **Figure 2**, and check again for smooth operation to wide open throttle, and then closed again.

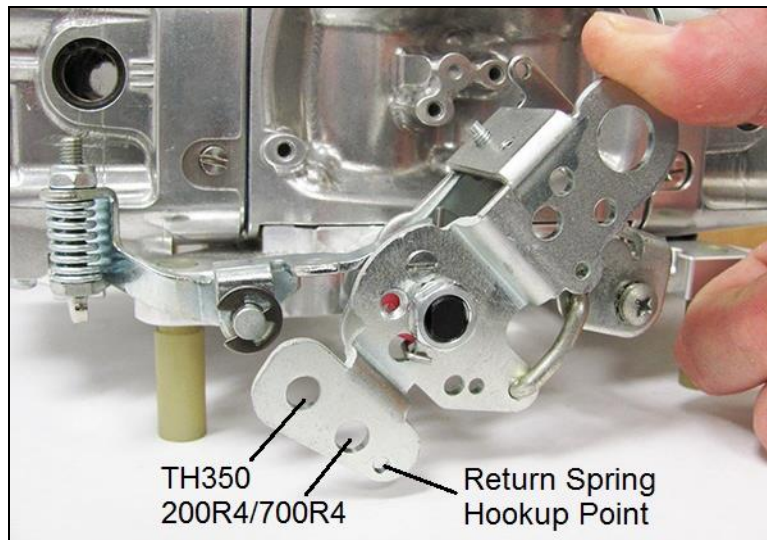

**Figure 7**

## Connecting the Transmission Linkage

### GM TH350, 200R4 /700R4

Attach the transmission kickdown stud (not supplied) into the proper hole location on the throttle lever as seen in **(Figure 7)**. Attach the TV cable to the stud and adjust per transmission manufacturer's specifications, using Chilton®, Motor®, or other repair manual designed for your specific transmission.

**WARNING:** If you are unfamiliar with overdrive transmission TV cable adjustments, consult a qualified transmission expert. Failure to properly adjust the TV cable on overdrive transmissions can lead to poor shifting and / or transmission failure. Demon Carburetion assumes no responsibility for transmission damage or failure caused by improperly adjusted TV cables.

## Connecting the Fuel Lines

Always use lines and fittings that are built for automotive use, and compatible with your type of fuel. Stainless steel braided, or push-lock type reinforced hose with AN swivel connections are recommended on all fuel lines. **Do not use thread lockers, sealing compounds, or PTFE tape on AN flare fittings.** When installing fuel bowl inlet fittings, use only the sealing washers or O-rings provided with the fitting.

In most cases, a drop of oil to prevent thread galling is all that's necessary when installing pipe threaded fittings. Remember to check for leaks when the system is under pressure. If a leak is detected, replace the malfunctioning part. When installing new fuel lines, be sure to flush the lines clear of any debris that might remain from the hose cutting or assembly process.

**NOTE:** All aluminum Demons have fuel inlet nuts installed.

## Vacuum Lines

All **Speed/Road Demon™** carburetors have three vacuum sources on the baseplate that can be used for PCV, distributor vacuum, diagnostics, or any other vacuum operated accessories **(Figure 8)**.

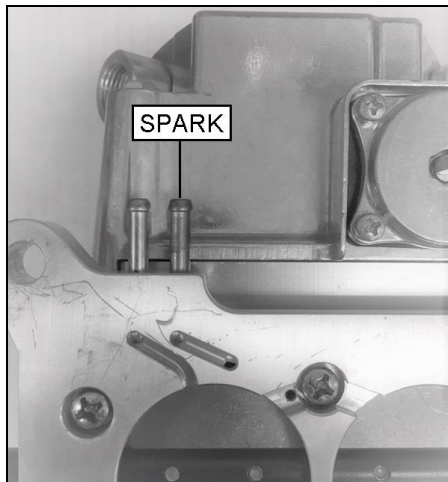

Speed Demon (Billet):

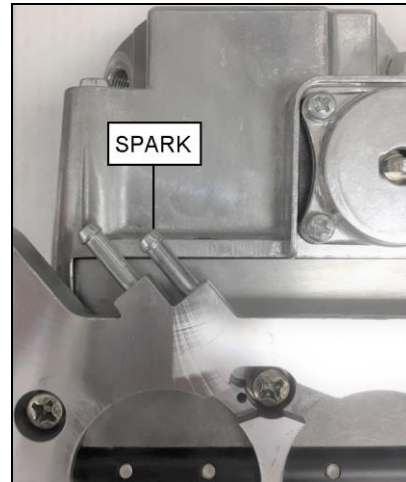

Road Demon (Cast):

The large fitting on the back of the baseplate, and the one of the two small fittings on the front of the baseplate, are direct (below the throttle plate) manifold vacuum sources. The front small fitting on the side of the baseplate, opposite the throttle linkage, provides a ported (above the throttle plate) vacuum source (use this port for the vacuum on a vacuum advance distributor). Be sure all vacuum lines are connected or plugged before you attempt to start the engine.

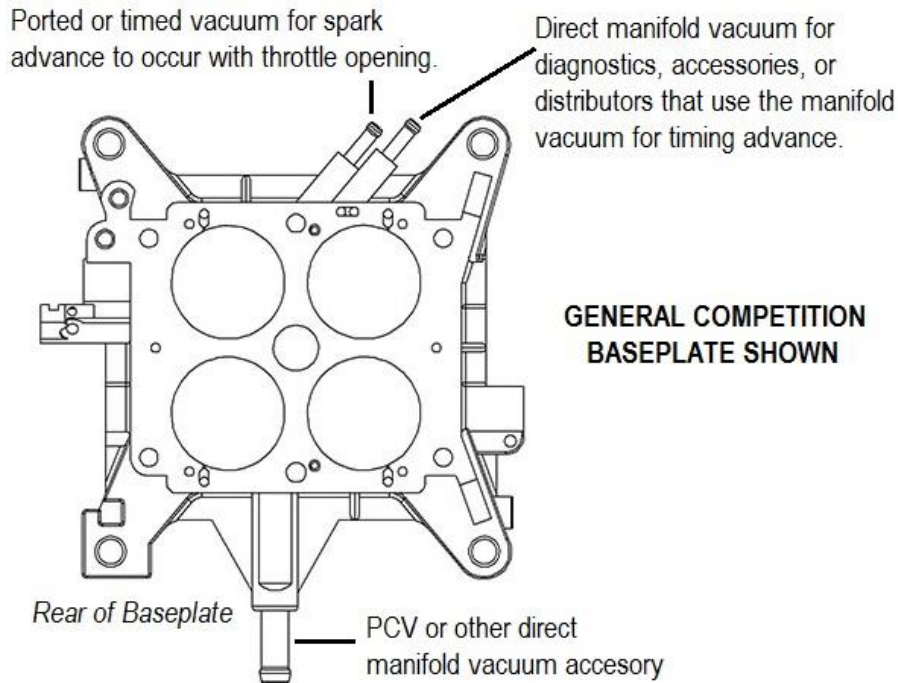

**Figure 8**

## Priming the Carburetor

Fill the bowl through the vent tube until fuel is visible in the sight window. Depress the accelerator pump levers once or twice until fuel is discharged from the pump discharge nozzles. On vehicles equipped with electric fuel pumps, bump the pump switch on and off to fill the bowls a little at a time. Avoid an abrupt surge of fuel into an empty carburetor. This can damage the floats and cause flooding. Remember to check for leaks. The engine should now be ready to start with a minimal amount of cold cranking.

## Ladies and Gentlemen, Start Your Engines!

Get a helper. Unless your car can be started from the engine compartment, starting your engine for the first time should always be performed with an assistant. A second set of eyes to watch for fuel leaks can be invaluable. A generous amount of initial timing is also beneficial to ease starting. We find 18-24° of advance suitable for most performance applications.

Before engaging the ignition, depress the throttle fully and release once or twice. Now, attempt to start the engine. If the engine does not fire under reasonable cranking, stop cranking and repeat the process once again. Each engine may require a different number of throttle shots to ease starting. Determine what is best for your engine.

If you change the adjustment of the idle speed setting screw for the warm up period, make a note of the screw setting so that it may be returned to its original position after warm up. This will prevent any drivability problems that could be caused by incorrect throttle plate position.

Allow the engine to achieve normal operating temperature before attempting final adjustments to the idle speed or idle mixture settings. It is however, acceptable to make float level or fuel pressure adjustments during the warm up period.

## Preliminary Tuning and Adjustments

The following preliminary adjustments should be made prior to attempting to drive the vehicle.

## Fuel Bowl / Float Level Adjustment

Although the float levels are preset during the assembly process, we recommend that they are rechecked each time the fuel bowls are removed from the carburetor. To verify the 'dry setting', simply invert the fuel bowl such that the weight of the float in the empty bowl rests against the needle and seat in the closed position. The distance between the top of the float and the inside top of the fuel bowl should measure approximately .400" to .500". A 13/32" or 7/16" drill bit is an excellent gauge for measuring this distance (**Figure 9**). Remember, this is only a provisional setting.

**NOTE:** Re-torque fuel bowl screws to 50 in./lbs. after the first 500 miles of operation.

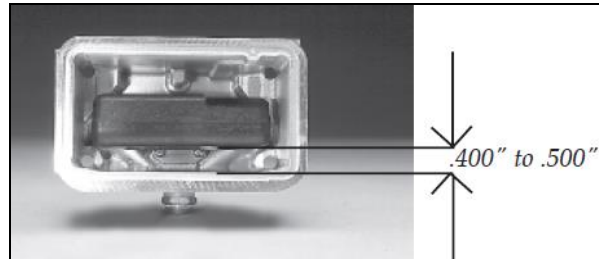

**Figure 9**

Final checking and adjustment must be made with the engine running and operating at the correct fuel pressure (6 – 7.5 PSI). Final fuel level adjustments can be made before the engine reaches operating temperature. A good initial setting is to have the fuel level in the sight window aligned with the center of the cast-in rib, as illustrated by the arrow (**Figure 10**).

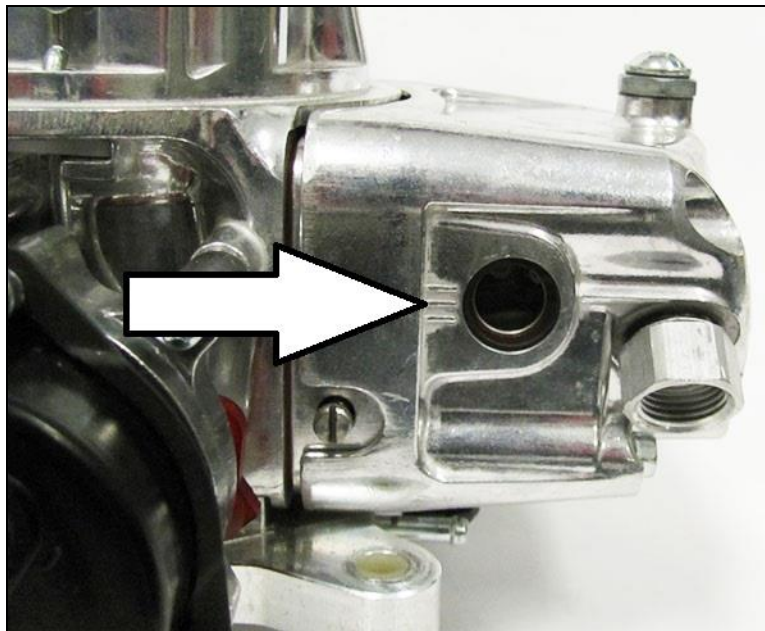

**Figure 10**

**NOTE:** For easy float adjustment, there are sight glass windows on both sides of the fuel bowl. Make sure the car is level when adjusting the float level.

Changing the float level is accomplished by loosening the locking screw and rotating the adjuster nut on the top of the bowl (**Figure 11**). To prevent fuel leakage during the course of adjustments, only loosen the locking screw enough to allow rotation of the adjuster nut. Rotating the adjuster nut clockwise will lower the float level setting; conversely, rotating the adjuster nut counterclockwise will raise the float level setting.





Use a wrench to hold the nut while turning the screw with a Phillips head screwdriver  
**Figure 11**

It's important to note that, although increased fuel levels are immediately visible in the sight glass, lowered fuel levels are not. The excess fuel in the bowl must be consumed before the fuel level can stabilize at the new lower setting. When lowering the float levels, allow the engine to run for a few minutes, or gently rev the engine until enough fuel is used to establish the new lower setting. For this reason, setting the floats a little low (.500" or more) during the 'dry setting' procedure, then raising them to the correct operating levels with the engine running, will prevent flooding at start up. It will also shorten the time necessary to reach the correct setting. Experimenting with float settings a little above or below the startup setting is also acceptable.

### **Curb Idle Speed and Mixture Adjustments**

Fine tuning of the idle speed and mixture must be done with the engine at or near operating temperature. A good rule of thumb is to not attempt adjustments until the engine has achieved 160 degrees water temperature. Adjusting the engine cold will usually result in a rich mixture at normal operating temperature. It is also helpful to use a tachometer and/or a vacuum gauge for setting the idle speed and mixture.

If you have set the throttle plates open for fast idle during warm up, return them to their original closed position as discussed in the preliminary set up instructions. If the engine stalls as you close the throttle plates, it is usually an indication of a lean idle condition. Turn all 4 mixture screws out 1/4 to 1/2 turn from the start up setting and re-fire the engine. Also check to be sure that with the engine idling, there should be no fuel visible dripping from the venturi boosters. If fuel is visible from the boosters, then the floats may be too high, the throttle plates are still too far open, or the fuel pressure is too high. Do not attempt to correct the idle mixture until the necessary adjustments have been made to stop fuel flow from the boosters. You may now evaluate the adjustment of the idle mixture screws. Adjusting the idle mixture usually takes two or more trips around the car. Turning the screws in, clockwise, reduces the amount of idle fuel and leans the idle mixture. Backing the screws out increases idle fuel and enriches the idle mixture.

Begin by turning each screw in 1/8 to 1/4 turn at a time. If idle speed decreases, back the screws out 1/8 to 1/4 turn. If idle speed increases, adjust them in again. Adjusting the screws to less than 1 full turn open can result in an off-idle stumble. However, some engines may respond well and not stumble with less than one turn.

The goal for best idle quality and throttle response is to have the engine idle with the throttle plates closed, at the correct RPM, with the highest manifold vacuum, and the mixture screws adjusted between 1 and 2 -1/2 full turns out from fully closed. Again, your particular combination may function correctly outside of this range.

If you have any further questions concerning the tuning of your carburetor, please contact the tech staff for more information.

## Fuel Pressure

Most gasoline powered engines usually require between 6 and 7-1/2 PSI fuel pressure. Gasoline carburetors can be run either at idle or wide open throttle at these pressures. Be sure your fuel delivery system is properly adjusted and able to maintain volume flow at these pressures. Improperly adjusted or inadequate fuel delivery will result in poor performance and possible engine damage.

## General Tuning and Component Information

Once you have completed the initial installation, and preliminary adjustments, you are now ready to test the vehicle and evaluate any other possible tuning adjustments. Information on changing the configuration or fuel metering of your Demon is also included in this section.

## Metering Blocks

The metering block is the part of the carburetor having the two-fold job of controlling the flow of fuel into the venturi along with the duty of mixing air and fuel prior to its introduction to the main air stream. This is done through a series of sized orifices located in the metering block. These orifices will be discussed from a tuning standpoint along with a discussion of the different metering blocks available for the Demon carburetors.

Each block is specifically tuned for its specific application. The metering blocks from Demon Carburetion are made of billet aluminum, compared with standard blocks that are cast zinc. This in itself offers a major advantage.

## Idle Feed Restrictor

The idle feed restrictor controls the amount of fuel that enters the idle circuit from the main well. This orifice controls the amount of fuel available for the idle circuit. If all other tuning results in a lean or rich idle circuit, an adjustment here may be necessary. As with any fuel restrictor, the larger the hole in the restrictor, the more fuel that will be introduced into the idle circuit. Make small changes, .001" or .002", to all four restrictors and work towards your desired tuning point.

**CAUTION:** The screw-in idle feed restrictors (**Figure 12**) are sized from the factory. Modification is not recommended.

Idle Feed Restrictors

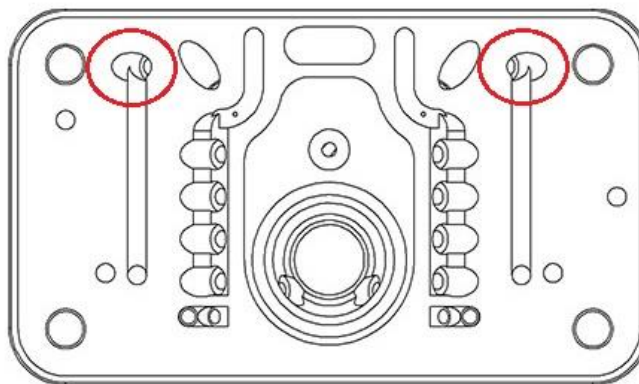
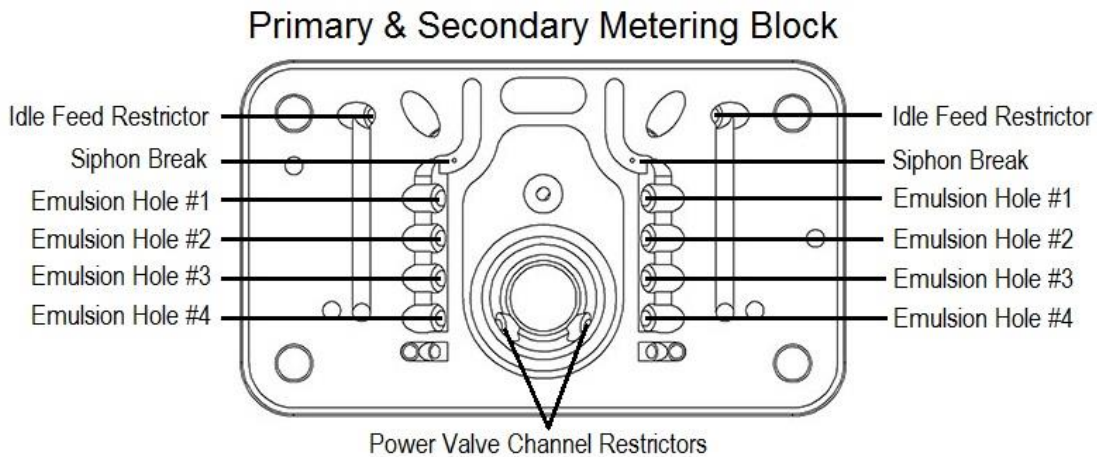

Figure 12

## Emulsion Bleeds

There are eight (8) emulsion bleeds per metering block, four (4) for each main well. These orifices play a part to control the density of the fuel in the block by metering the amount of air that is introduced into the fuel in the

main well. This, in conjunction with the air bleeds in the main body, help to control the shape of the fuel curve. The emulsion circuitry of your **Speed/Road Demon™** has been engineered through extensive wet flow, dyno and street & track testing. **A note of caution:** tuning of emulsion bleeds should be done only by those with a deep knowledge of carburetors, otherwise, a poor running engine or damaged internal engine parts could be the result.



## Main Well Jets

Main jets, located along the bottom edge of the block on the side opposite the bleeds, control the amount of fuel that enters the metering blocks, and for that matter, the amount of fuel moved by the carburetor. If the engine appears to be running rich through the entire powerband, a reduction in jet size will lean the fuel curve out. Jets are numbered, and the larger the number, the greater the amount of fuel that will be able to enter the fuel circuits.

Tuning should be done by making jet changes of a number or two, in either direction. As with any engine tuning, erring to the rich will produce less than optimal performance, whereas the same mistake to the lean can result in severe engine damage. Err to the rich!

Demons produce a very linear fuel curve, however it differs from the curve of other carburetors. Due to the improved atomization characteristics of the Demon, tuners with data acquisition equipment may notice brake specific numbers lower than what has become known as the “normal.” A Demon with an overly rich tune-up may act excessively sluggish compared to other style carburetors. In other words, if you attempt to match “normal” brake specific numbers, you may be left with a sluggish Demon that is operating well below its potential.

**NOTE:** All Holley and Quick Fuel Technology jets will work with these carburetors.

## Power Valves

The power valve, located in the primary metering block between the two main jets, offers a boost in available fuel to the engine in high load conditions without creating an over-rich idle or part throttle. These are Four Door® Power valves. Power valves are marked with a vacuum rating. This rating is the point at which the valve will open. The lower the number, the more the vacuum has to drop for the valve to open. When the engine is under a big load, it produces decreased manifold vacuum along with an increased demand for fuel. When the manifold vacuum is less than the rating on the power valve, it opens and allows extra fuel to enter the main circuit of the metering block. It is a good idea to have a power valve rating that is lower in number than the vacuum produced by the engine at idle.

Power Valve located here

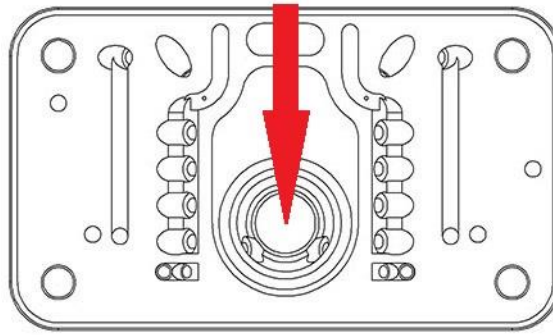

Figure 14

**NOTE:** All Holley and Quick Fuel Technology 6/32 bleeds will work in these blocks.

### Demon Inlet Fittings

Demon fuel bowls feature 9/16" x 24tpi threaded fuel inlets that accept the following fittings:

FITTING TYPE	MANUFACTURER	PART NUMBER
#8 FEMALE SWIVEL	BG FUEL SYSTEMS	140024DEM
#6 FEMALE SWIVEL	BG FUEL SYSTEMS	140026DEM
#6 STANDARD	EARL'S	991942ERL

### Main Body

The main body's unique top shape increases the air flow capacity over standard carburetor designs. The accelerator pump squirter and the air bleed bosses have been moved back to further improve flow characteristics. These changes have an effect on the overall performance of the carburetor.

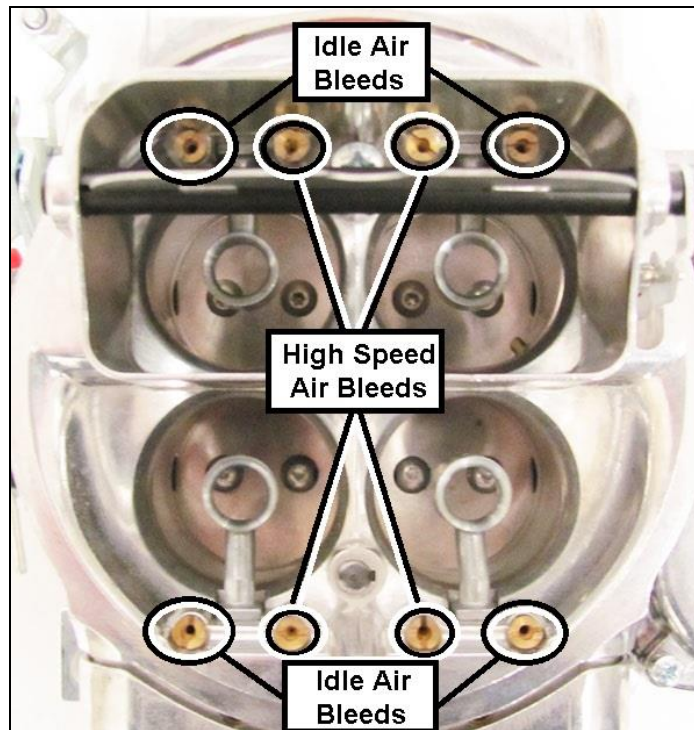

Figure 15

## 10-32 Air Bleeds

The screw in air bleeds, located in the upper bowl portion of the main body between the wall and the venturi, shape the fuel curve by helping to control when the idle and main circuits start. The four (4) idle air bleeds are located closest to the air cleaner ring, while the four (4) high speed air bleeds are found on either side of the squirter bosses. A larger bleed can be used to slow down, or delay, the related circuit, and vice-versa for a smaller bleed. As with the emulsion bleeds, tuning with the air bleeds should be done only by someone with a deep understanding of carburetion to prevent a poorly operating carburetor. If air bleeds are changed, be careful not to drop them down the venturi or serious engine damage can occur.

**NOTE:** All Holley and Quick Fuel Technology 10-32 air bleeds will work in these carburetors.

## Squirters

The exit orifice diameter of the squirter controls the duration of the pump shot. The smaller the diameter, the longer it will take for the complete volume of the pump to discharge. A larger diameter discharges the pump's volume quickly. This is assuming no changes in pump cams.

## Mechanical Secondary Throttle Linkage

There are two styles of secondary connecting links for a Demon; one to one and progressive. The one to one link, which is the longer of the two links, opens the secondaries at nearly the same time and rate as the primary throttle blades. The progressive link allows the primary blades to open about 1/3 of their total travel before the secondaries begin to open. The one to one link is installed in the lower of the two holes on the primary throttle linkage, while the progressive is installed in the upper hole. Both links install into the oval slot on the secondary and are secured by a small washer and cotter pin.



*Speed/Road Demon™ mechanical secondary carburetors are supplied with the progressive link.*

**Figure 16**

A change in these links has its greatest effect on drivability. The one to one link produces an increased availability of air/fuel to the engine earlier. The progressive link delays this availability until later in the linkage travel. Both have their advantages. The choice is up to the individual driver.

## Adjustable Vacuum Secondary Housing

1. **Baseline setting** for the adjustable needle is 1 1/2 turns off the seat, this setting has already been made during assembly at our facility. Should you ever need to re-establish your needle setting, lightly seat the needle. Do not over-tighten as this will alter the seat taper and could change the performance characteristics.

2. The Quick Set Adjustable Vacuum Secondary Housing incorporates a “Purple” spring. This ensures the secondaries will open fully on most applications. The purpose of the adjustment screw is to vary the opening rate, that is, when the secondaries begin to open as well as how quickly they open.



3. The secondary diaphragm operates off venturi vacuum. As airflow increases through the primary side of the carburetor, a vacuum is created in the venturi. It is this vacuum signal that actuates the secondary diaphragm. Without an accelerator pump on the secondary side of the carburetor it is necessary to graduate the secondary-opening rate. Air responds instantaneously when the throttle plates open, however, there is a delay before the fuel begins to flow.

4. For best performance you should not “feel” the secondaries opening. If you “feel” the secondaries open, do not confuse this feeling with better performance. That feel is actually a hesitation or a bog. Simply stated, the increased airflow has insufficient fuel to make a combustible mixture.

5. Best performance therefore is accomplished by determining what needle position creates a hesitation. Then gradually turn in the adjustment needle in 1/8-turn increments until the hesitation is eliminated. This will provide the optimum wide-open throttle acceleration.

6. The Quick Set Adjustment will allow you to tune for variations in traction, weather conditions, etc. How your engine responds to these conditions will determine where the adjustment screw should be set. This will require experimentation on your part; however, the Quick Set Adjustment will enable you to achieve the best performance possible under all conditions.

## Electric Chokes Wiring & Tuning

1. Run a wire from a switched +12V source to the connection on the pod cover marked with a (+). Run a second wire from the terminal marked (-) to a good ground. See **Figure 17**.

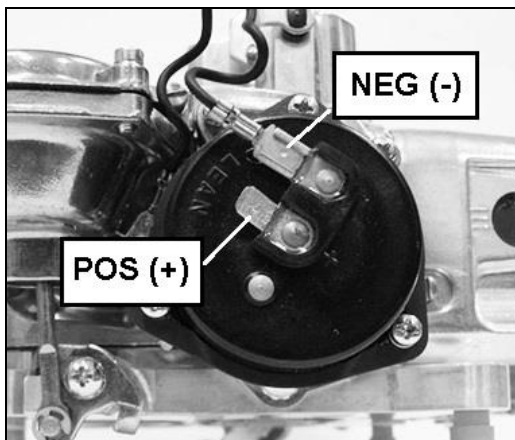

**Figure 17**

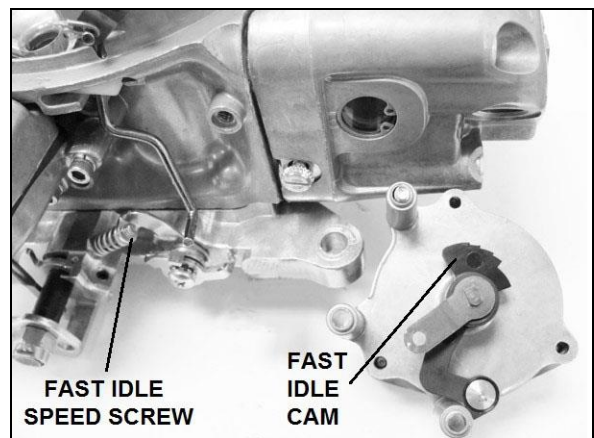

**Figure 18**

2. There are two primary adjustments: the fast idle speed screw and the choke timing. The choke idle speed screw controls how far the primary butterflies are open when the choke butterfly is closed or partially closed. It sets your fast idle. The screw is located on the bracket that is slipped over the throttle shaft, behind the choke pod (**Figure 18**). This idle can be increased by turning the choke idle screw clockwise, or decreased by turning it counter-clockwise. It is important to note that when the choke butterfly is open completely (vertical up and down), the choke idle speed screw must not be holding the primary butterflies

open at all. In other words, when the choke idle speed screw is in the deepest cut on the fast idle cam, it must not be hitting the fast idle cam.

## Idle-Eze

The Idle-Eze™ feature allows you to set your idle speed while maintaining the correct orientation of the throttle plates with the transfer slots. This provides better control of the idle mixture screws, and results in a cleaner idle, crisper throttle response, and quicker tuning. The Idle-Eze™ also helps in overcoming idling difficulties in engines with larger camshafts.

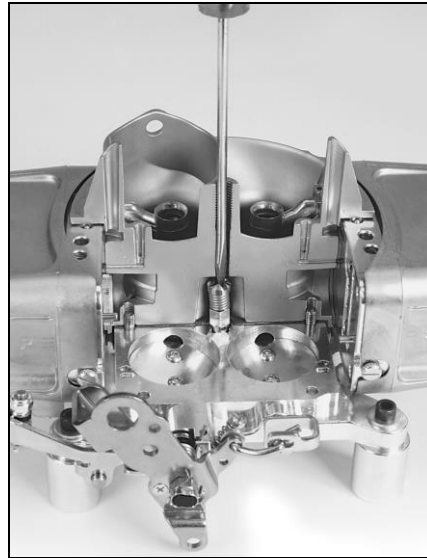

Figure 19

### Setup & Tuning instructions:

Adjust the throttle plates before installing the carburetor on the engine. On engines that idle at 1000 RPM or higher, set both the primary and secondary throttle plates open by the same amount. As a starting point (with the carburetor upside down), set the throttle plates such that they expose approximately .020" of the transfer slots. The transfer slots are the thin slots milled in the baseplates and are approximately 5/16" in length (Figure 20).

With .020" showing, the transfer slot will give the appearance of a little square situated below the throttle plates (Figure 21).



Figure 20

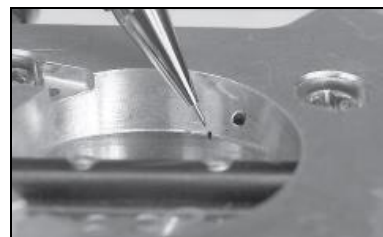

Figure 21

On engines that idle below 1,000 RPM, set the primary throttle plates open to the .020" (square) as described above, but the secondary throttle plates should be set to the bottom of the transfer slot. In other words, at idle speed the secondary transfer slots will not be visible when viewed from the bottom, but any movement of the secondary throttle plates will expose the slot.

The next step is to provisionally set the Idle-Eze™. Insert a screwdriver through the air cleaner stud hole to engage it, and turn the screw clockwise until the screw stops. Now, reverse it counter-clockwise by 1-1/2 turns. This will serve as a good baseline.

Use a screwdriver through the air cleaner stud hole to control the engine's RPM. Once the RPM is set approximately and the engine is running at normal operating temperature, begin to adjust the idle-mixture screws. Adjust the screws either in (leaner) or out (richer) until the engine reaches its optimum idle. Adjustments in small increments of, say, approximately 1/4-of-a-turn at a time is recommended. Once the idle mixture has been set, adjust the Idle-Eze™ by using a screwdriver through the air cleaner stud hole to reach desired RPM. Once satisfied, install the air cleaner stud and air cleaner and make sure its presence doesn't change the idle settings or RPM. If it does, the carburetor will require readjustment so it performs properly with the air cleaner installed. Once it does, you're finished and ready to enjoy your carburetor.

## FORD KICKDOWN LINKAGE

1. Unlock transmission kickdown lever by removing screw and spring and relocating to additional hole in the transmission kickdown lever (**Figure 22**).
2. Install snap ring on the transmission kickdown lever.
3. Install transmission kickdown lever return spring bracket using supplied screws and lockwashers.
4. Install transmission kickdown lever spring between the transmission kickdown lever and kickdown return spring bracket.

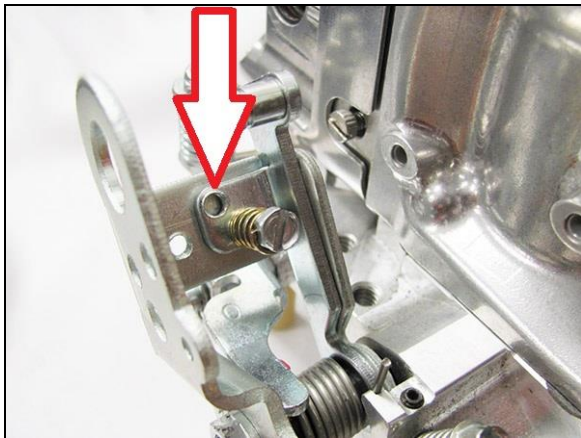

**Figure 22**

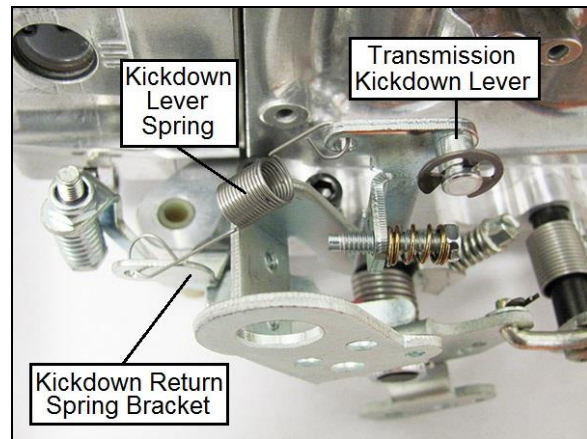

**Figure 23**

**NOTE: IF YOU HAVE ANY QUESTIONS ABOUT THE SETUP OR TUNING OF THIS CARBURETOR, PLEASE CONTACT THE DEMON CARBURETOR™ TECHNICAL DEPARTMENT DIRECTLY AT 270-781-9741.**

© 2017 Demon Carburetion™ All rights reserved.

**LIT733**

**Date: 4-5-17**