



Edelbrock E-Force Supercharger

2011-2013 Dodge/Chrysler 5.7L and 6.4L HEMI

Part #1534 and 1535



Edelbrock E-Force Supercharger System 2011-'13 Dodge/Chrysler 5.7L and 6.4L Hemi

Installation Instructions

INTRODUCTION

Thank you for purchasing the Edelbrock Hemi Supercharger System for various Chrysler/Dodge vehicles. The Edelbrock E-Force Supercharger System for the 2011-2012 Hemi utilizes Eaton's Gen VI TVS Supercharger rotors, featuring a four lobe design with a full 160° of twist for maximum flow, minimum temperature rise, quiet operation, and the reliability for which Eaton is known. The Edelbrock Supercharger is a complete system that maximizes efficiency and performance by minimizing air restriction into, and out of, the supercharger. This results in maximum airflow, with minimal temperature rise and power consumption. The supercharger housing itself is integrated into the intake manifold for a seamless design with minimal components, eliminating the possibility of vacuum leaks between gasket surfaces. The system also utilizes a front drive, front inlet configuration giving it the shortest, least restrictive inlet path on the market. The supercharger is inverted, expelling the air upward. Air pressure then builds in the plenum, before being pushed through the intercooler, oriented horizontally, above the supercharger outlet. After passing through the intercooler core, the air travels through the long runners, which route straight down into the cylinder head ports. This configuration allows for a compact package that can fit under the stock hood and cowl of the vehicles for which it was designed, without sacrificing runner length, or intercooler area. The E-Force supercharger features a uniquely styled plenum, and includes matching side covers. The Edelbrock supercharger provides neck snapping performance that is safe to operate on a completely stock engine. It can be had with an optional 5-year 100,000 mile warranty so that there are no worries when installing it on a brand new car.

TOOLS AND SUPPLIES REQUIRED

- Jack and Jack Stands OR Service Lift
- Panel Puller
- Ratchet and Socket Set including: 7mm, 8mm, 10mm (standard, deep and swivel), 11mm, 12mm (deep), 13mm, 15mm, 18mm, 21mm (deep), 24mm
- Wrenches including: 8mm, 18mm, 27mm
- 1/2" Breaker Bar
- Flat Blade & Philips Screwdrivers
- Compressed Air
- 90° Power Drill
- Allen Wrenches including: 1/4", 5mm, 6mm, 8mm
- Mechanic's Wire
- Chrysler Fuel Pump Lock Ring Remover/Installer #9340 OR Equivalent
- Side Cutters
- Dremel
- 3/8" Fuel Line Removal Tools
- Torque Wrench
- Needle Nose Pliers
- Pliers OR Hose Clamp Removal Tool
- Impact Wrench
- Blue & Green Loctite Retaining Compound or equivalent
- O-ring Lube
- Masking Tape
- Electrical Tape



**Edelbrock E-Force Supercharger System
2011-'13 Dodge/Chrysler 5.7L and 6.4L Hemi**

Installation Instructions

IMPORTANT WARNINGS

Before beginning installation, use the enclosed checklist to verify that all components are present in the box then inspect each component for damage that may have occurred in transit. If any parts are missing or damaged, contact Edelbrock Technical Support (800-416-8628), not your parts distributor.



WARNING: *Installation of this supercharger will result in a significant change to the performance characteristics of your vehicle. It is highly recommended that you take some time to familiarize yourself with the added power, and how it is delivered, in a controlled environment. Take extra care on wet and slippery roads, as the rear tires will be more likely to lose traction, with the added power. It is never recommended to turn off your vehicles traction control system.*

Proper installation is the responsibility of the installer. Improper installation will void all manufacture's standard warranties and may result in poor performance and engine or vehicle damage.

Inspect all components for damage that may have occurred in transit before beginning installation. If any parts are missing or damaged, contact Edelbrock Technical Support, not your parts distributor.

Due to the complexity of the Edelbrock E-Force Supercharging system, it is recommended that this system only be installed by a qualified professional with access to a service lift, pneumatic tools, and a strong familiarity with automotive service procedures. To qualify for the optional supplemental warranty, it is necessary to have this system installed by a Certified ASE Technician at a licensed business, Dodge/Chrysler Dealership, or an Authorized Edelbrock Installer. Failure to do so will void and/or disqualify any and all optional supplemental warranties offered with this system. Please contact the Edelbrock Technical Support department if you have any questions regarding this system and/or how your installer of choice will affect any warranty coverage for which your vehicle may qualify.

Any previously installed aftermarket tuning equipment must be removed and the vehicle returned to an as stock condition before installing the supercharger.

Any equipment that directly modifies the fuel mixture or ignition timing of the engine can cause severe engine damage if used in conjunction with the Edelbrock E-Force Supercharger System. This includes, but is not limited to: OBDII programmers, MAF sensors, adapters and any other device that modifies signals to and/or from the ECU. Aftermarket bolt-on equipment such as underdrive pulleys or air intake kits will also conflict with the operation of the supercharger and must be removed prior to installation. Use of any of these products with the E-Force Supercharger could result in severe engine damage.



Edelbrock E-Force Supercharger System 2011-'13 Dodge/Chrysler 5.7L and 6.4L Hemi

Installation Instructions

IMPORTANT WARNINGS cont'd



91 octane or higher gasoline is required at all times. If your vehicle has been filled with anything less, it must be run until almost dry and refilled with 91 or higher octane gasoline twice prior to installation.

Any failures associated with not using premium 91 octane gasoline or higher, will be ineligible for warranty repairs.

Edelbrock periodically releases improved versions of the calibration file found on the supplied handheld programmer. Check the website to ensure you have the latest version, as described in the Test Flash Procedure on Page #9.

NOTE: If you get the message on your InTune programmer that reads: "This vehicle needs an update Download here: www.diablosport.com/dcx." This is because the programmer needs to update the vehicle's stock calibration file because the vehicle currently has an older calibration that is not supported by the programmer, this does not mean that the programmer itself needs an update.

Please go to www.diablosport.com/dcx and it will instruct you how to update the calibration for your vehicle.

It is also recommended that you check the Edelbrock Tech Center Website for any updates to this installation manual. Please refer to the lower right hand corner to verify that you have the latest revision of this installation manual before beginning the installation.

Tech Center: http://www.edelbrock.com/automotive_new/misc/tech_center/install/index.php

Edelbrock Authorized Installer Disclaimer

Authorized installers of Edelbrock products are independent companies over which Edelbrock has no right of control. Edelbrock LLC makes no claims regarding the abilities, expertise or competency of individual employees of any authorized installer. Each authorized installer is an independent company and makes its own independent judgments. Edelbrock LLC specifically disclaims any responsibility to any party including third parties for the actions, or the failure to act, of individuals, agents or a company authorized in the installation of Edelbrock LLC products.



Installation Instructions

INSTALLATION HARDWARE IDENTIFICATION GUIDE

(Parts Are Note To Scale)

Bag #1



(4x) - M6 x 1.0 x 40mm
Hex Flange Bolt



(12x) - M6 x 1.0 x 30mm
Hex Flange Bolt

(1x) - Throttle Body O-Ring *(Included, but not shown)*

Bag #2

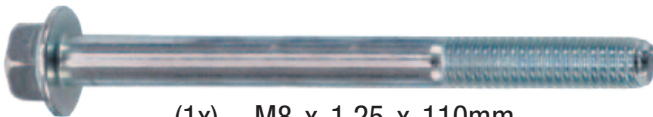

(1x) - M8 x 1.25 x 110mm
Hex Flange Bolt

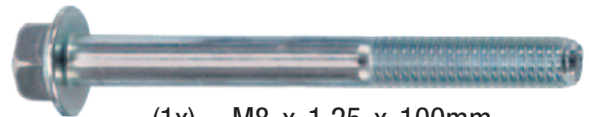

(1x) - M8 x 1.25 x 100mm
Hex Flange Bolt



(1x) - M8 x 1.25 x 100mm
Socket Head Bolt

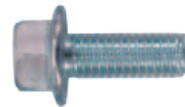

(1x) - M8 x 1.25 x 25mm Hex
Flange Bolt



(1x) - M8 Washer

Bag #3



(3x) - M8 x 1.25 x 30mm
Hex Flange Bolt



(2x) - M8 x 1.25 x 20mm
Hex Flange Bolt



(4x) - M6 x 1 x 25mm
Hex Flange Bolt



(4x) - M6 x 1 x 16mm
Hex Flange Bolt



(8x) - 3/4" Hose Clamp



(4x) - 3/8" Hose Clamp



(2x) - M8 x 1.25
Hex Flange Nut



(1x) - 3/8" Hose Coupler



**Edelbrock E-Force Supercharger System
2011-'13 Dodge/Chrysler 5.7L and 6.4L Hemi**

Installation Instructions

INSTALLATION HARDWARE IDENTIFICATION GUIDE, Con't

(Parts Are Note To Scale)

Bag #4



(1x) - 1/4" x 1/2" Steel Dowel



(1x) - 15/64" High Speed Steel Drill Bit



(1x) - .2500" Reamer



(1x) - Crank Pinning Drill Guide

Bag #6



(4x) - Washer



(4x) - Spacer



(4x) - M6 x 1 x 12mm
Socket Head Bolt



(4x) - Coil Cover
Ball End Stud



(1x) - Coil Cover Bracket,
Front, Driver Side



(1x) - Coil Cover Bracket,
Front, Passenger Side



(2x) - Coil Cover
Bracket, Rear



(4x) - Coil Cover Standoff



(4x) - Coil Cover
Grommet



Edelbrock E-Force Supercharger System 2011-'13 Dodge/Chrysler 5.7L and 6.4L Hemi

Installation Instructions

HOSE IDENTIFICATION GUIDE

(Parts Are Note To Scale)

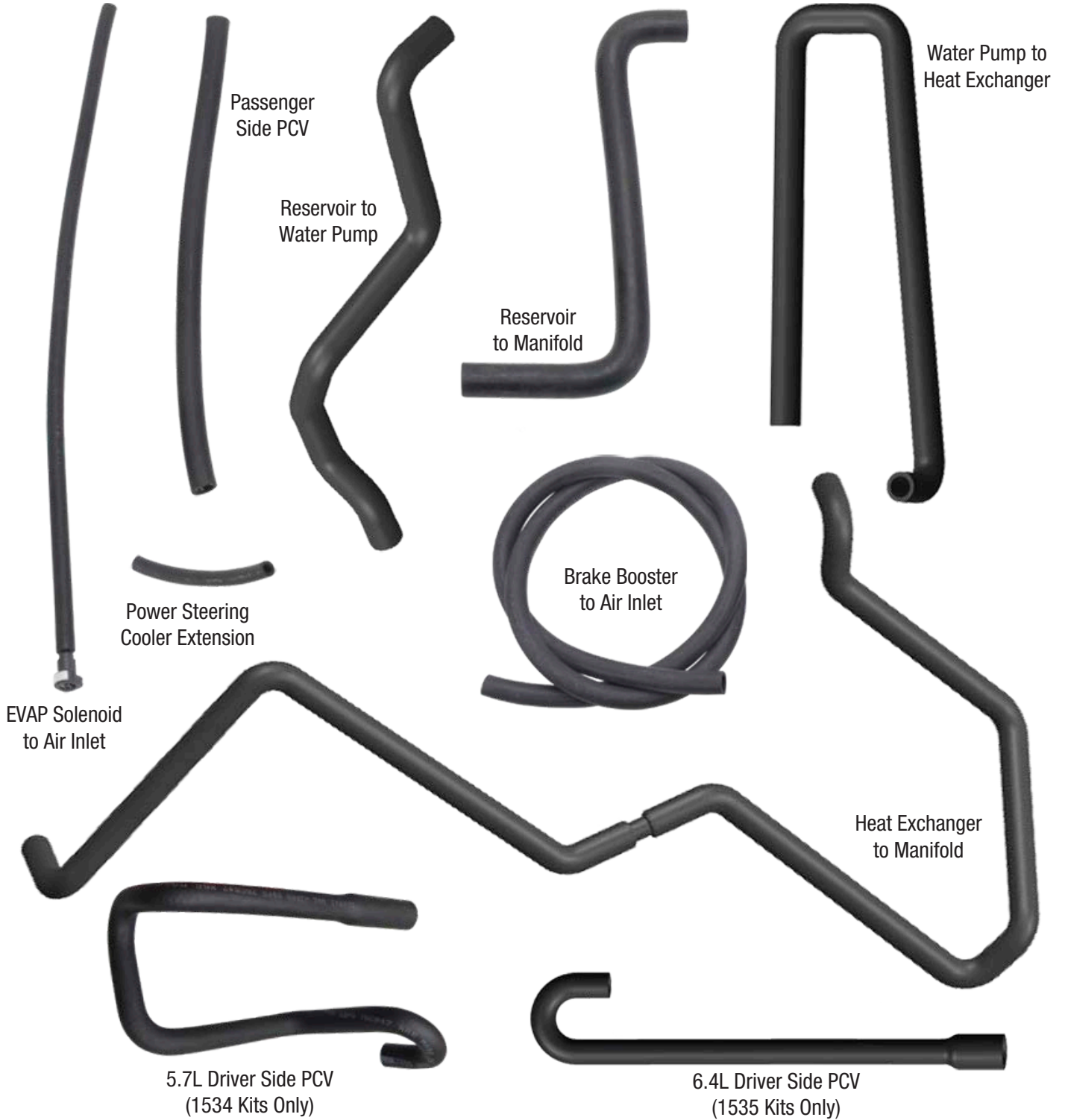



Installation Instructions

HOSE ROUTING DIAGRAM

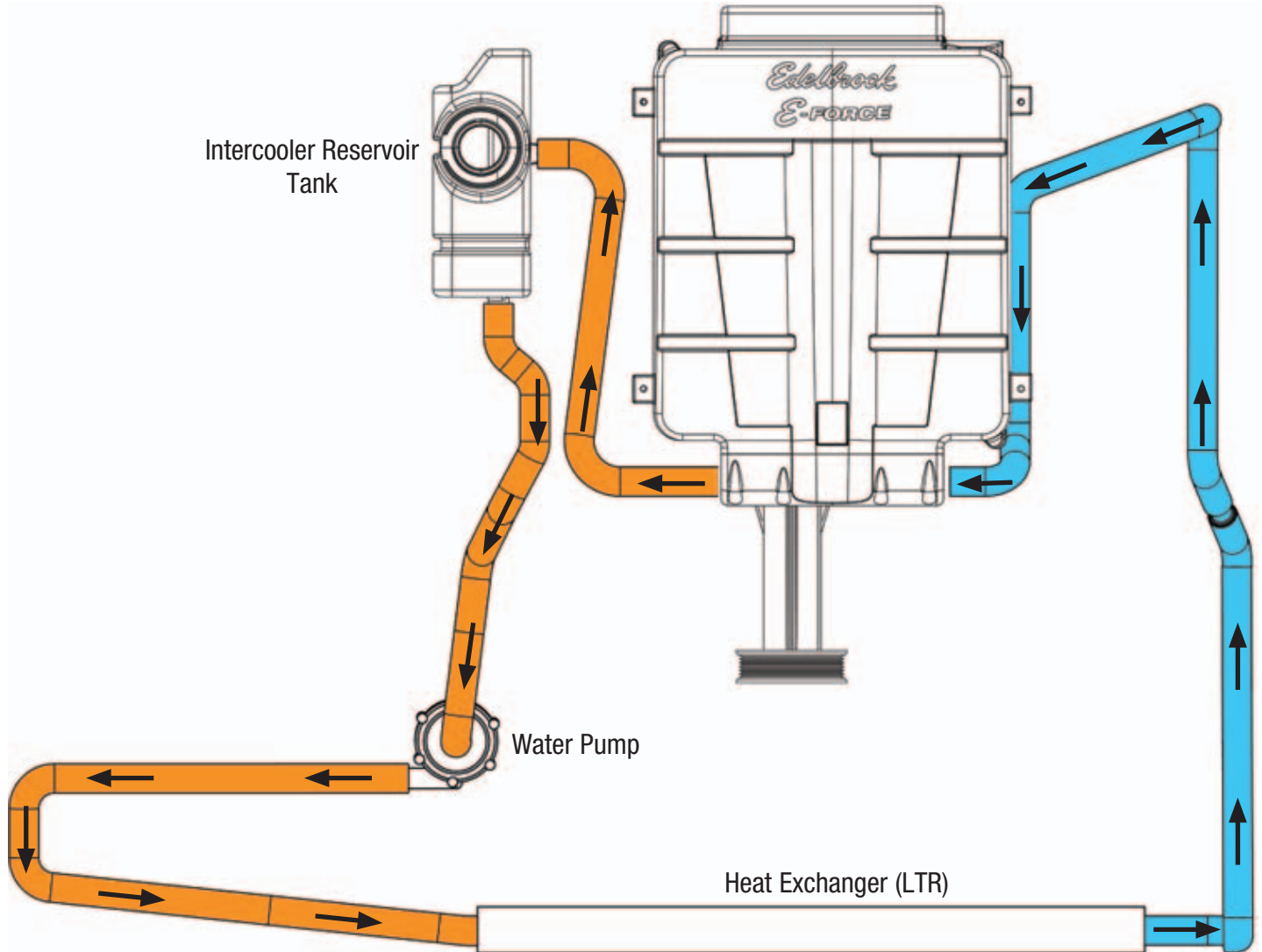



Edelbrock E-Force Supercharger System 2011-'13 Dodge/Chrysler 5.7L and 6.4L Hemi

Installation Instructions

WIRE HARNESS GUIDE

(Parts Are Note To Scale)

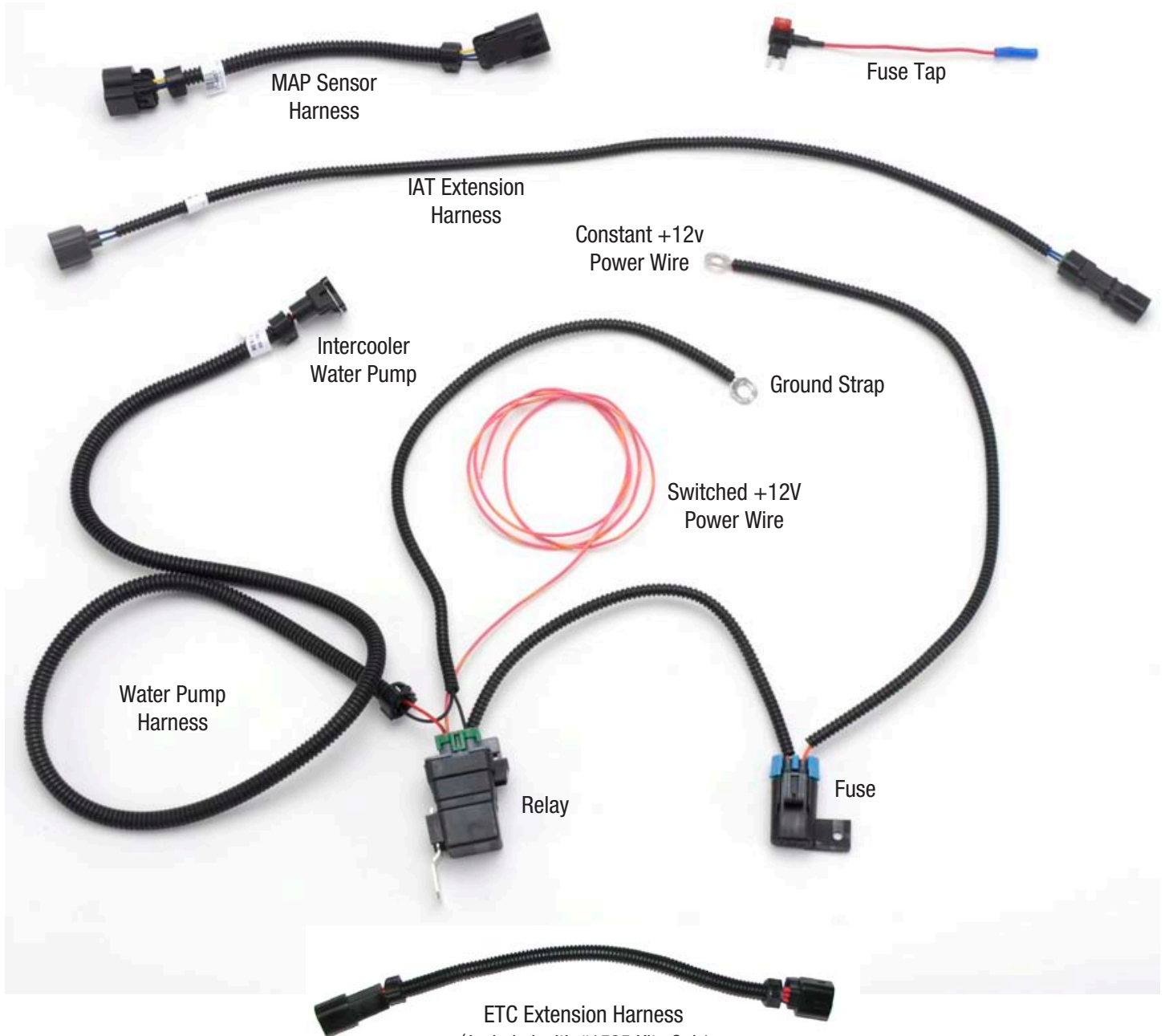

(Included with #1535 Kits Only)
Note: #1535 kits include two ETC Extension Harnesses. 2013 and newer model years will use the 6 pin, inline harness.



Edelbrock E-Force Supercharger System 2011-'13 Dodge/Chrysler 5.7L and 6.4L Hemi

Installation Instructions

Test Flash Procedure

- Verify that your vehicle's ECU is up to date.
Original Equipment Manufacturers often release updates to the computer programming for your vehicle. Edelbrock highly recommends that you verify with your new car dealer, that your vehicle is equipped with the latest software version from your vehicle's manufacturer before attempting to load the Edelbrock tune.
- Verify that the programmer is up to date by connecting it to your PC using the supplied USB cable. Please see the Quick Reference Guide included with your Diablo inTune programmer for more details.
- Confirm that your programmer has the latest calibration by checking the Edelbrock website (http://www.edelbrock.com/automotive_new/mc/superchargers/software-tech.shtml).
- Once you have found the latest tune on the website, power on the programmer by connecting it to the USB port on your computer, then select SETTINGS and confirm your selection.
- Select TOOL INFO, then select FIRMWARE INFO. Verify that the Edelbrock calibration file is the same as the version on the website. If they are different, download the new calibration as instructed on the website.

NOTE: If you get the message on your InTune programmer that reads: *"This vehicle needs an update Download here: www.diablosport.com/dcx."*, this is because the programmer needs to update the vehicle's stock calibration file because the vehicle currently has an older calibration that is not supported by the programmer, this does not mean that the programmer itself needs an update.

Please go to www.diablosport.com/dcx and it will instruct you how to update the calibration for your vehicle.

- Once you have verified that the ECU, Programmer and Calibration are up-to-date, plug the supplied programming module into the OBD-II port of the car, located below the steering column.
- Put the car into ACC mode, but don't start the vehicle.
- After the inTune screen loads, select TUNE VEHICLE from the main menu.



- Select WRITE VEHICLE from the Tuning Menu.



- When prompted, turn the key to the ON position but do not start the vehicle.
- Once the vehicle is recognized, select the Edelbrock Tune from the menu.
- Confirm the selection by pressing the green check icon. *NOTE: The programmer will automatically save a backup copy of your existing vehicle calibration.*
- You will be asked if you wish to modify the tune. Press the green check icon to make specific modifications (tire sizes, gears, shift firmness, etc.) or press the red X to skip this step. *NOTE: If modifying tire sizes, you will need to check your tire manufacturer's website to determine the tire revolutions per mile for your tires.*



Edelbrock E-Force Supercharger System 2011-'13 Dodge/Chrysler 5.7L and 6.4L Hemi

Installation Instructions

- The selected tune will now be written to your vehicle. This process can take several minutes.

NOTE: If this process fails to complete, make sure that the battery is at the proper voltage and retry.

- When the download is complete you will be prompted to disconnect the Diablo Sport Tuner from the OBD-II port of your vehicle.

Post Successful Test Flash

- If you are ready to install the supercharger, proceed to Step 1 of the Supercharger Installation.

OR

- If you wish to return the ECU back to the factory calibration, such that the vehicle can still be driven until you are ready to begin the installation, then:

- Put the car into ACC mode, but don't start the vehicle.
- Connect the supplied PCM cable to the OBD-II connector.
- Select TUNE VEHICLE from the Main Menu.
- Select RESTORE VEHICLE from the Tuning MENU.
- When prompted, turn the key to the ON position but do not start the vehicle. Your original factory settings will be re-flashed to your ECU.
- Unplug the programmer cable from the OBD-II port when calibration is complete and when prompted to do so.
- When you are ready to install the supercharger, proceed with Step 1 and you will be prompted to re-flash the ECU towards the end of the installation procedure.

Supercharger Installation

CAUTION - 5.7L Engine Only: This installation requires replacement of the in-tank fuel pump. Before beginning the installation, make sure the fuel level of the vehicle is below 5/8 of a tank to avoid fuel spillage in the vehicle.

NOTE: For vehicles driven competitively or in an aggressive manner, Edelbrock recommends the use of the following, colder, spark plugs:

NGK IX Iridium 6619 LFR6AIX-11 - 2011-2012 w/ 5.7L only (not included)

NGK IX Iridium 2315 LZTR6AIX-13 - All other models (not included)

For normal street driving, stock equipped spark plugs, re-gapped to .028" are sufficient.

1. Use a 10mm wrench to loosen and remove the negative battery terminal.



2. Vehicles equipped with 5.7L engines need to install the supplied fuel pump module at this time. The fuel pump module installation procedure can be found on page 29.

3. Raise the front of the vehicle up with a service lift or equivalent.

4. Use a 10mm socket to remove the 4 bolts retaining the rear plastic splash shield and remove.

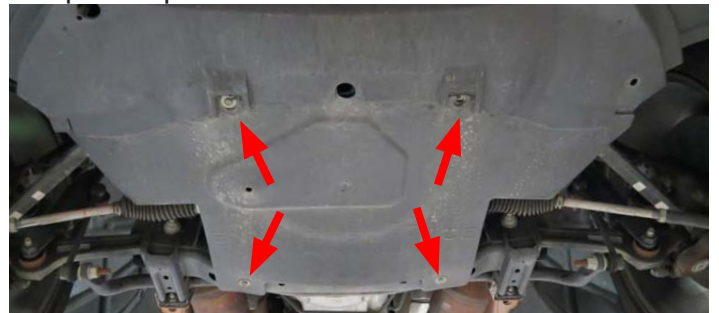



Edelbrock E-Force Supercharger System 2011-'13 Dodge/Chrysler 5.7L and 6.4L Hemi

Installation Instructions

5. Using a panel puller, remove six (6) body pins from the front splash shield. Some vehicles are equipped with ten (10) body pins.



6. Using a 7mm socket, remove the nine (9) bolts retaining the splash shield to the front lip. Some vehicles are equipped with only seven (7) retaining bolts.



7. Disconnect the lighting harness connector from the main engine harness if the vehicle is equipped with fog lamps.



NOTE: Chrysler vehicles disregard Step 8 and proceed to Step 9.

8. Lift the plastic radiator shroud covers from underneath the hood latch and put them aside.



9. Dodge vehicles need to remove six (6) body pins, under the plastic radiator shroud, securing the fascia using a panel puller.



Chrysler vehicles need to remove seven (7) body pins securing the fascia using a panel puller.

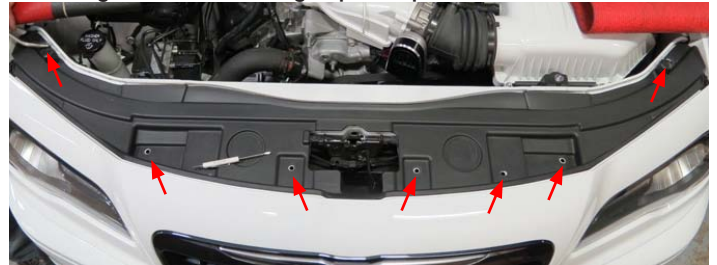



Edelbrock E-Force Supercharger System 2011-'13 Dodge/Chrysler 5.7L and 6.4L Hemi

Installation Instructions

NOTE: Step 10 is for Chrysler vehicles only, disregard and proceed to Step 11 otherwise.

10. Use a 10mm universal socket to remove the bolts at both top corners of the front fascia. Proceed to Step 11.



11. Use a panel puller to remove three (3) body pins securing the wheel well to the front fascia.



12. Use a 10mm socket to remove the bolts behind each front wheel well.



NOTE: Chrysler vehicles disregard Step 13 and proceed to Step 14.

13. Use a 10mm deep socket to remove the nut inside each of the front wheel wells next to the headlight. **NOTE:** Remove front wheels to make nuts more accessible. Proceed to Step 14.

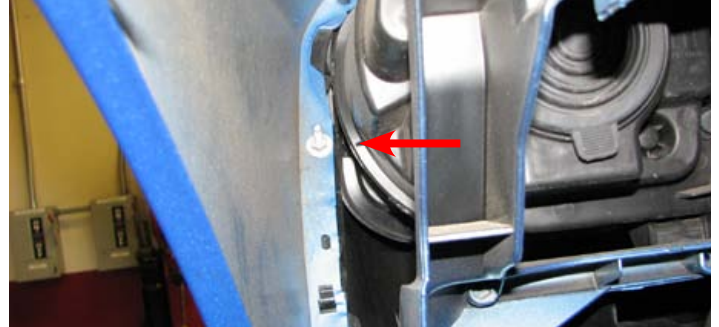

14. Carefully detach the sides of the front fascia and remove. Chrysler vehicles must also detach the top corners of the fascia.



15. Unplug the ambient temperature sensor and detach the harness from the radiator shroud using a panel puller to remove the panel pin.

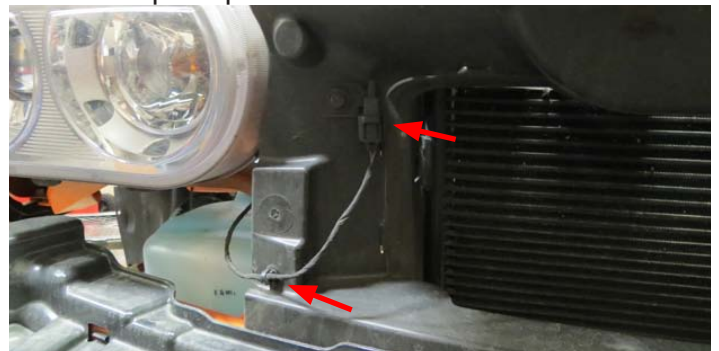



Edelbrock E-Force Supercharger System 2011-'13 Dodge/Chrysler 5.7L and 6.4L Hemi

Installation Instructions

NOTE: Dodge Challengers are equipped with a front fascia supports and a front bumper absorber highlighted in Steps 16-17. Dodge Chargers and Chrysler 300s disregard and proceed to Step 18.

16. Using a panel puller, remove three (3) body pins securing the front bumper absorber. Detach the locking tabs from the front bumper absorber and remove.

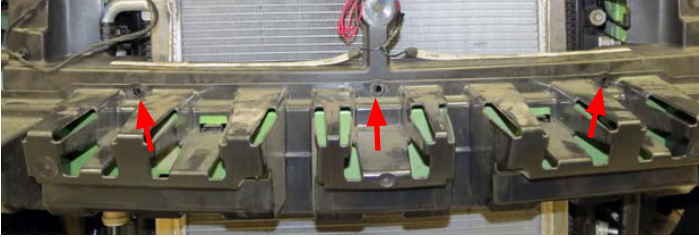

17. Using a panel puller, remove four (4) body pins securing the front fascia support and remove. Proceed to Step 19.



NOTE: Dodge Chargers and Chrysler 300s are equipped with a two piece radiator shroud highlighted in Step 18. Dodge Challengers proceed to Step 19.

18. Using a panel puller, remove four (4) body pins securing the radiator shrouds. The lower shroud can be removed from the upper shroud if necessary.

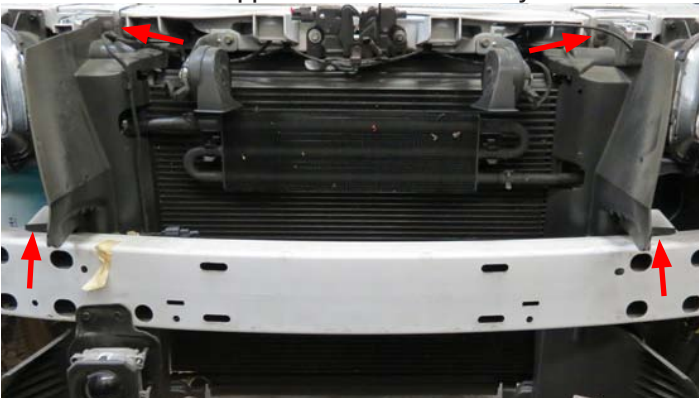

19. Remove the plastic engine covers from the valve covers by lifting them by the ends.

20. Place a drain pan below the petcock on the passenger side of the radiator then loosen the petcock and drain the coolant. Reinstall petcock when radiator is drained.



21. Use a 3/8" drive breaker bar to loosen the tension on the belt tensioner and remove the drive belt.



22. Remove the driver side PCV hose. Note that the 5.7L and 6.4L have different driver side PCV configurations.

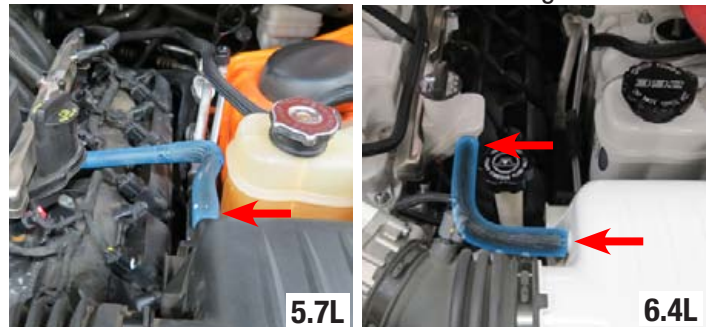



Edelbrock E-Force Supercharger System 2011-'13 Dodge/Chrysler 5.7L and 6.4L Hemi

Installation Instructions

23. Pull the EVAP hose off the nipple on the solenoid mounted on the passenger side firewall. Then remove the hose from the front of the manifold.



24. Loosen the worm clamps securing the air inlet tube to the airbox and throttle body. Disconnect the engine harness from the IAT sensor and remove the air inlet tube. Using a 10mm socket, remove the bolt securing the stock airbox and remove the airbox.

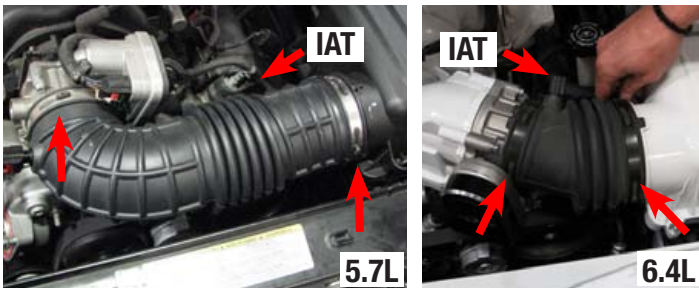

25. Disconnect the electric throttle control connector from the throttle body.



26. Detach the quick release fuel line from the driver side fuel rail. **CAUTION: Fuel may be under pressure, cover with rag to prevent fuel from spraying.**



27. Unplug all eight (8) fuel injector connectors. Then use an 8mm socket to remove the ten (10) manifold bolts.

28. Unplug the MAP connector from the MAP sensor and the Active Runner Control connector from the back of the manifold. **NOTE: Some vehicles are not equipped with Active Runner Control.**



29. Remove the brake booster hose from the check valve on the brake booster.

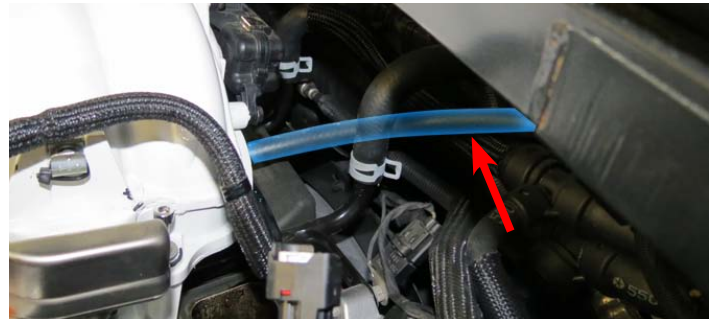

30. Carefully remove the intake manifold and set aside.

31. Use a soft cloth to clean the intake flange of the cylinder heads, using caution to make sure dirt or debris do not fall into the intake ports. Once the intake flanges are cleaned, cover the ports with protective tape to prevent any foreign objects from falling into the ports.





Edelbrock E-Force Supercharger System 2011-'13 Dodge/Chrysler 5.7L and 6.4L Hemi

Installation Instructions

NOTE: Step 32 is only for vehicles with Active Runner Control. Disregard otherwise.

32. Using electrical tape, tape up the Active Runner Control connector to prevent any water from contacting the connector terminals.

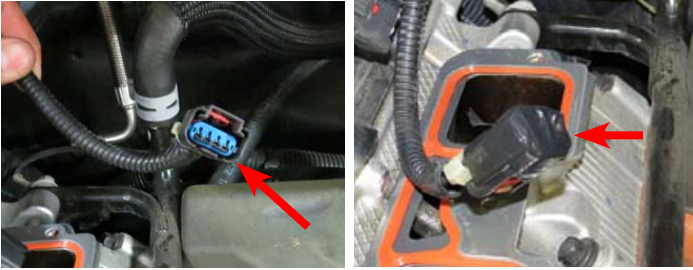

33. Using a 10mm socket, remove two (2) bolts securing each ignition coil. Remove the coils and note their order so that they can be reinstalled in the same order.

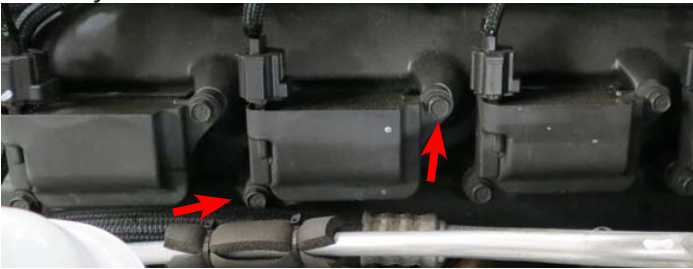

34. Using a 5/8" spark plug socket, remove all 16 spark plugs. Inspect and replace them as needed, or replace them with colder plugs recommended before Step 1. Both stock and new plugs must be gapped to .028". Apply anti-seize to the threads of each plug and install. Torque each spark plug to 7.5-15 ft/lbs.

35. Reinstall the ignition coils in the same location they were originally and secure them with the stock bolts.

36. Remove the airbox shroud by removing two retaining pins on the top of the shroud and two (2) on the side of the shroud.

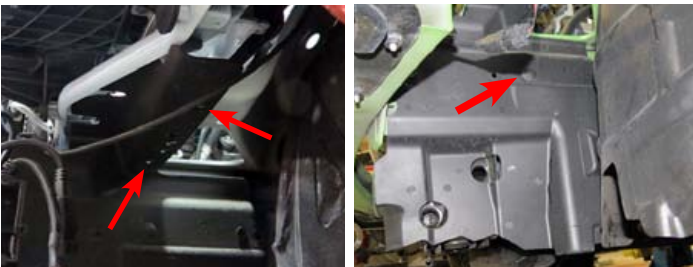

37. Using mechanic's wire or equivalent, securely hang the A/C condenser to the vehicle. Using an 8mm socket, remove four (4) bolts securing the A/C condenser to the radiator assembly.



38. Remove all radiator hoses from the radiator if not already done so. Remove the fan harness and clip from the radiator assembly. Using a 13mm socket, unbolt the radiator support brace.



39. With the help from an assistant, carefully lower the radiator assembly and set aside.





Edelbrock E-Force Supercharger System 2011-'13 Dodge/Chrysler 5.7L and 6.4L Hemi

Installation Instructions

NOTE: Step 40 is for vehicles equipped with manual transmissions only. Automatic transmission vehicles can remove the crank bolt using an impact gun or equivalent.

40. Using a 10mm socket, remove the flywheel dust cover. Insert an 8mm allen key into the flywheel. Place a rag in between the allen key and transmission to protect the transmission surface.



41. Using a 21mm socket and breaker bar, remove the factory crank bolt. Using the supplied crank bolt, install the drilling guide with the flat side facing outwards. Position drilling bushing in a comfortable position for drilling.



42. Mark the supplied drill bit 1.3" from the end of the tip with masking tape. Using the drilling bushing as a guide, drill into crank until the tape mark on the drill bit meets the drilling guide.



43. Use compressed air to clean out any debris present from the drilling. **CAUTION:** Use extreme caution when doing this to make sure debris does not get past the seal into the crankcase, as this will require a great deal of disassembly to correct or could cause severe engine damage if ignored.

44. Loosen the guide bolt and rotate the guide to line up the reaming hole with the hole drilled. Use the back of the supplied reamer to center the reaming hole to the drilled hole. Tighten down the crank bolt to secure the guide and ream the hole with the supplied reamer.

45. Remove the drilling guide and clean out the hole in the crank with compressed air. Apply Green Loctite (*Red Loctite can be used if Green Loctite is not available*) to the supplied crank pin and tap it into the hole in the crank.



46. Using a 21mm socket, reinstall the factory crank bolt and torque to 127 ft/lbs. Remove the allen key and reinstall the dust cover if applicable.

47. Using a 16mm socket, remove the belt tensioner. **NOTE:** Tensioner must be removed to mount the supplied idler bracket.



Edelbrock E-Force Supercharger System 2011-'13 Dodge/Chrysler 5.7L and 6.4L Hemi

Installation Instructions

NOTE: Step 48-50 are for vehicles with electronic power steering. Please disregard and proceed to Step 51 if your vehicle is equipped with a power steering pump.

48. Using a 13mm socket, remove the upper left bolt from the idler pulley assembly and the water pump bolt directly above the belt tensioner.



49. Using the short spacer and the bolts from Bag #2, loosely mount the idler bracket to two bolt hole locations from Step 48. Using the long spacer and M6 x 110mm bolt from Bag #2, secure the bracket to the third bolt location; the provision on the cylinder head above the idler pulley bolt removed from Step 48. Torque all bolts to 21 ft/lbs.

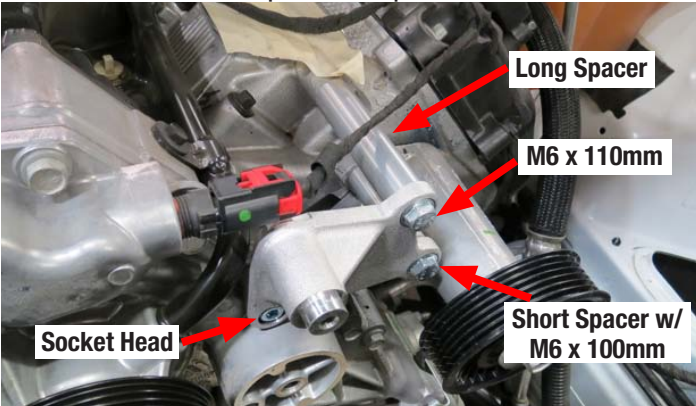

50. Using a 13mm socket, replace the grooved pulley on the factory idler bracket with the supplied 90mm grooved pulley. Make sure to apply Red Loctite, or equivalent, to the threads of the factory bolt before installing. Torque bolt to 18 ft/lbs. Proceed to Step 54.

NOTE: Step 51-53 are for vehicles equipped with a power steering pump. Please disregard and proceed to Step 54 if vehicle is equipped with electric power steering.

51. Using a 13mm socket, remove the upper left bolt from the power steering pump and the water pump bolt directly above the belt tensioner.



52. Mount the idler bracket to the location shown below using the long spacer and bolts from Bag #2. Torque bolts to 21 ft/lbs.

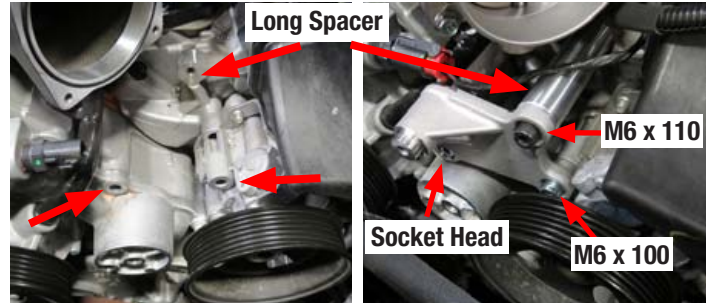

53. Using a 16mm socket, install the supplied upgraded belt tensioner using the factory bolt. Torque to 32 ft/lbs.

54. Install the supplied 76mm idler pulley to the idler bracket using the M8 x 25mm bolt and M8 washer from Bag #2. Make sure to apply Red Loctite, or equivalent, to the threads of the bolt before installing. Torque bolt to 18 ft/lbs.





Edelbrock E-Force Supercharger System 2011-'13 Dodge/Chrysler 5.7L and 6.4L Hemi

Installation Instructions

55. Use a 3/8" Fuel Line Removal Tool to detach the fuel input line from the factory hard line near the firewall on the passenger side. Attach the 90° end of the supplied fuel input line to the factory hard line.



56. Remove the tape covering the intake ports of the heads and inspect the area to ensure that no residue remains on the flanges. Lay the supplied manifold gaskets flat on the intake flanges.



57. Remove the plastic film from the supercharger ports if not already done so. With the help of an assistant or a cherry picker, lift the supercharger into the engine bay. Use the intake bolt holes and injector bores to achieve the best alignment possible between the engine and the supercharger.



58. Use a 10mm universal socket to install eight (8) M6 x 30mm intake manifold bolts from Bag #1 following the sequence shown below. Torque all bolts to 9 ft-lbs in the same order.

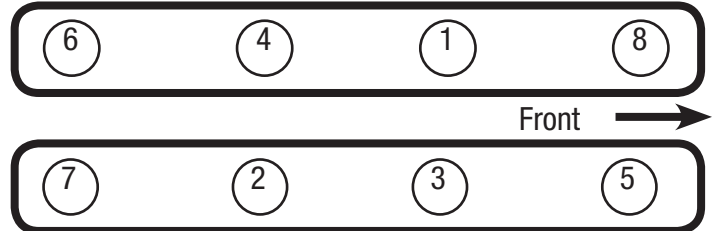

59. Install the supplied drive belt using the belt routing diagram below.

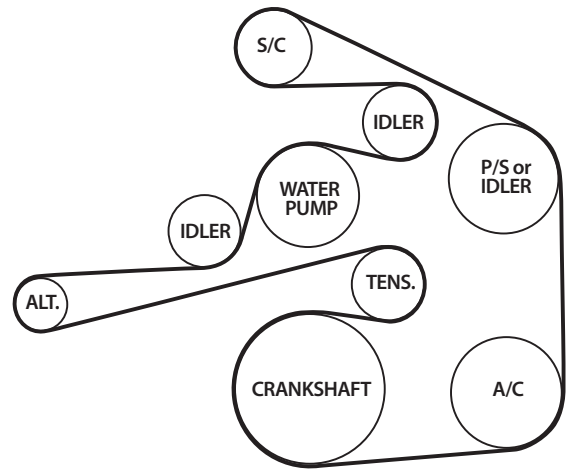

60. Apply O-ring lube to the O-rings of the supplied fuel rail fittings. Install the two straight fittings on the rear provisions of the rails. Install the 180° fitting on the front provision of the passenger side rail and the plug in the front provision of the driver side rail.

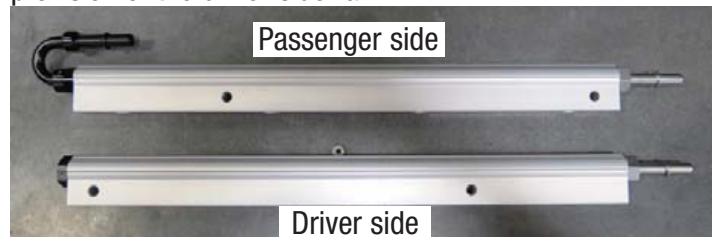

61. Apply O-ring lube to the upper O-rings of the supplied fuel injectors, then install them into the fuel rails with the connectors oriented away from the supercharger.



Edelbrock E-Force Supercharger System 2011-'13 Dodge/Chrysler 5.7L and 6.4L Hemi

Installation Instructions

62. Apply O-ring lube to the lower O-rings of the fuel injectors, then install the driver side fuel rail by sliding the injectors down into the manifold provisions and applying pressure until the mounting holes in the rails line up with the manifold.

63. Attach the supplied fuel rail crossover line to the straight fitting on the passenger side fuel rail.

64. Route the fuel crossover hose behind the manifold and around the fuel supply line as you install the passenger side fuel rail. Connect the fuel crossover to the straight fitting on the driver side rail. Connect the fuel supply line to the 180° fitting on the front of the passenger side rail.



65. Using a 10mm socket, secure the fuel rails to the manifold using four (4) M6 x 30mm bolts supplied in Bag #1. Remove the oil fill cap from the stock intake manifold and install it on the supercharger. Reconnect all eight (8) fuel injector connectors.



66. Remove the 2nd and 4th upper valve cover studs on each side of the engine. Then remove the rubber bushings from the four (4) valve cover studs.



67. Depending on your application, there will be two different factory valve cover bushings: a 5/8" diameter and a 7/8" diameter. The 5/8" diameter bushings will install onto the supplied hex coil cover supports using the spacers from bag #6. The 7/8" diameter bushings will use the washers from bag #6.

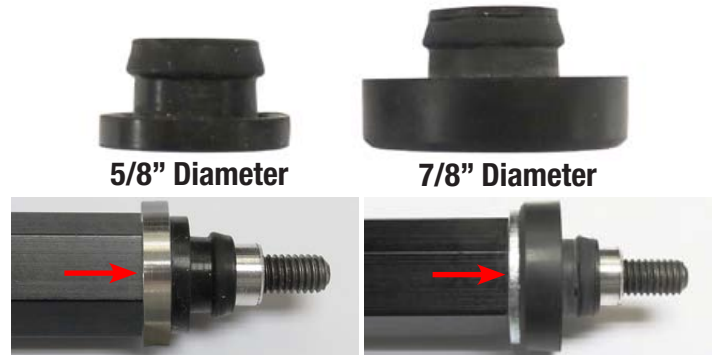

68. Thread the assembled hex coil cover supports into the valve cover stud provisions from Step 66.

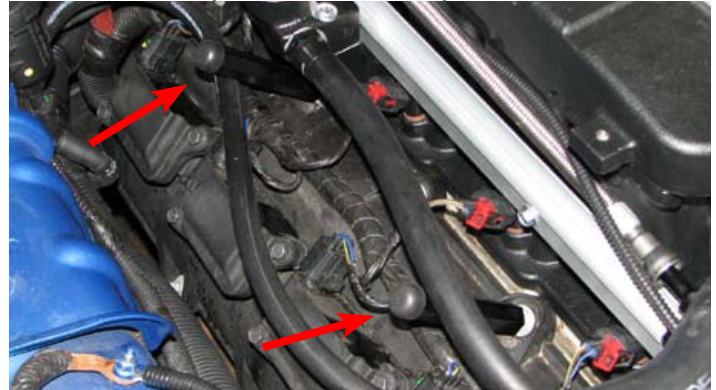

69. Attach the supplied brake booster hose to the check valve and route the hose to the driver side air inlet located on the supercharger snout.





Edelbrock E-Force Supercharger System 2011-'13 Dodge/Chrysler 5.7L and 6.4L Hemi

Installation Instructions

70. Attach the supplied passenger side PCV hose to the front fitting on the passenger side of the air inlet and then to the PCV fitting as shown.



71. Install the supplied EVAP hose to the EVAP solenoid and connect the quick connect fitting end to the rear barb on the manifold as shown.

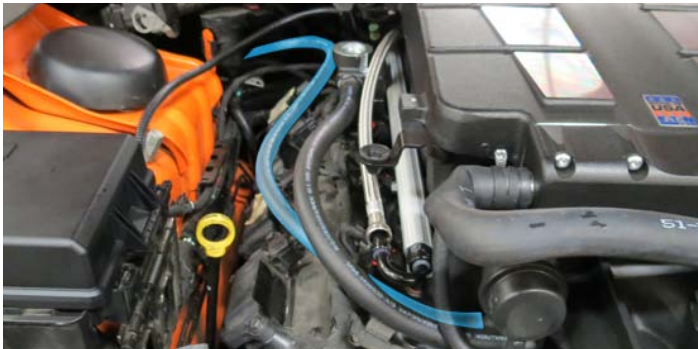

72. Loosely mount the water pump to the water pump bracket using the bracket strap and one (1) M8 nut from Bag #3.

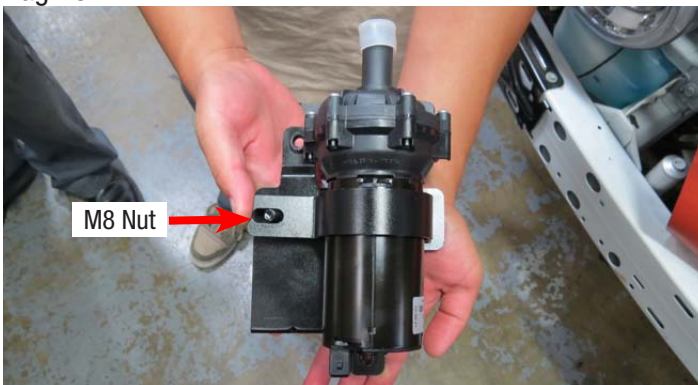

73. Mount the water pump assembly to the passenger side frame rail using the supply M8 x 20mm bolts from Bag #3. The bracket will be sandwiched between the frame and radiator support.

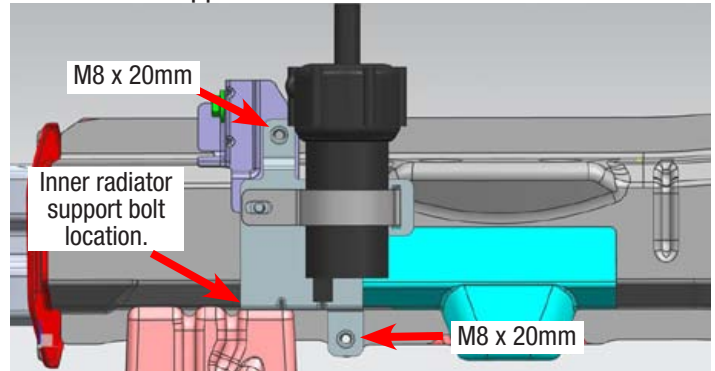

74. Route the straight end of the Water Pump to LTR hose under the passenger side head light towards the water pump. Connect the hose to the outlet of the water pump and secure with a hose clamp from Bag #3. Securely fasten the bolt on the water pump strap. *NOTE: The other end of the hose will connect to the Low Temp Radiator (LTR) later.*

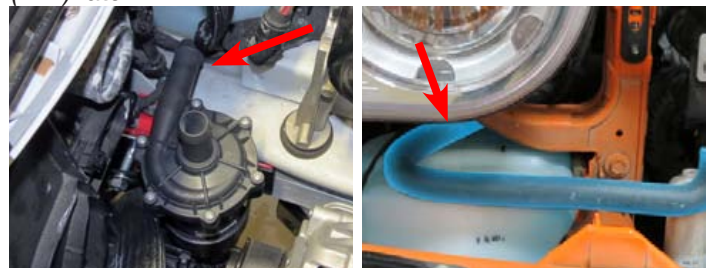



Edelbrock E-Force Supercharger System 2011-'13 Dodge/Chrysler 5.7L and 6.4L Hemi

Installation Instructions

NOTE: Steps 75-79 pertains to vehicles with power steering pumps. If your vehicle does not have a power steering pump, disregard and proceed to Step 80. The oil cooler must be moved up to clear the (LTR).

75. Unplug both horn connectors and remove horn assembly using a 10mm socket. Make sure to identify the driver side horn from the passenger side horn.

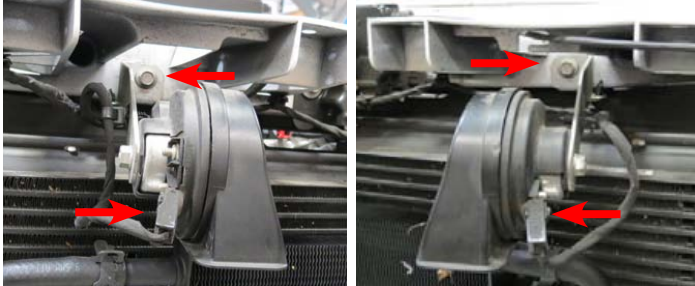

76. Remove the power steering oil cooler from the retaining clips. Using a panel removal tool or equivalent, carefully remove the retaining discs behind the A/C condenser.
NOTE: If necessary, new factory retaining clips can be purchased at your local dealership (PN - 05183297AB).



77. Extend the passenger side power steering oil cooler hose using the supplied 3/8" coupler, oil hose extension, and 3/8" hose clamps. **NOTE:** Some oil spillage may occur, make sure to clean any spillage before proceeding.



78. Reattach the retaining clips to the oil cooler. Reinstall the oil cooler assembly to the first row of the A/C Condenser as shown below. Secure the oil cooler assembly to the A/C condenser with the retaining discs.



NOTE: Dodge Chargers and Chrysler 300s will use the longer black horn brackets. Dodge Challengers will use the shorter zinc horn brackets.

79. Reinstall horns using the factory hardware and supplied mounting brackets.

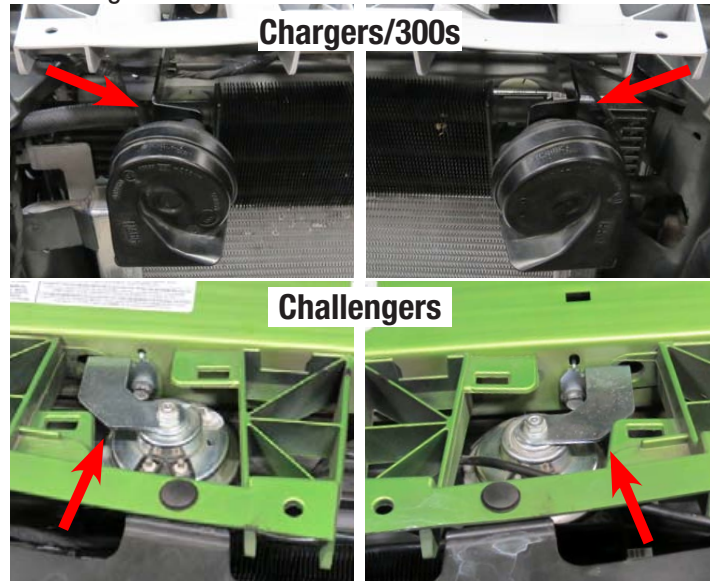



Edelbrock E-Force Supercharger System 2011-'13 Dodge/Chrysler 5.7L and 6.4L Hemi

Installation Instructions

80. Reinstall the radiator assembly using the factory bolts. Reinstall the upper and lower radiator hoses.



81. Using side cutters or equivalent, cut off the condenser support cables.

82. Position the supplied low temperature radiator (LTR) in front of the AC condenser. Lineup the mounting holes on the LTR and A/C condenser. Secure the LTR and A/C condenser to the radiator assembly with the factory bolts.

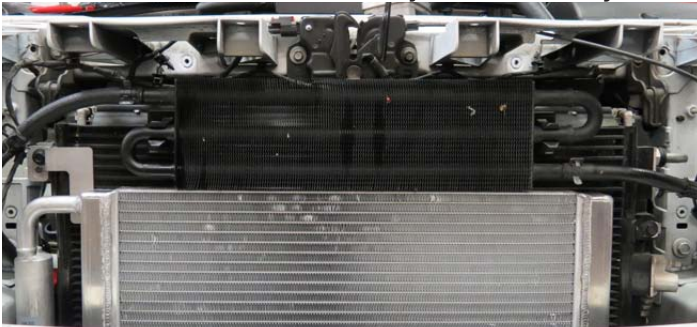

83. Reinstall the airbox shroud using the factory hardware.

84. Mount the intercooler reservoir to the supplied bracket using the four M6 x 16mm bolts supplied in Bag #3.



85. Use a 13mm socket to remove the two inner nuts on the passenger side strut tower. Secure the intercooler reservoir assembly onto the strut tower studs and tighten. Torque nuts to 20 ft/lbs.



86. Attach the Reservoir to Water Pump hose to the front provision of the intercooler reservoir and secure it with a hose clamp from Bag #3. Route the hose down to the inlet of the water pump and secure it with a hose clamp.

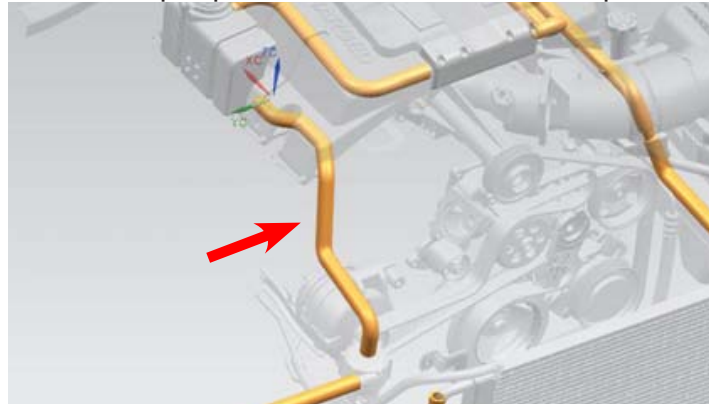

87. Install the Manifold to Tank hose between the supercharger and tank. Secure both ends of the hose with hose clamps from Bag #3.





Edelbrock E-Force Supercharger System 2011-'13 Dodge/Chrysler 5.7L and 6.4L Hemi

Installation Instructions

88. Connect the previously install Water Pump to LTR hose to the LTR and secure with a hose clamp from Bag #3. Apply six (6) inches of convolute sleeve to the LTR hose and secure with electrical tape or equivalent.

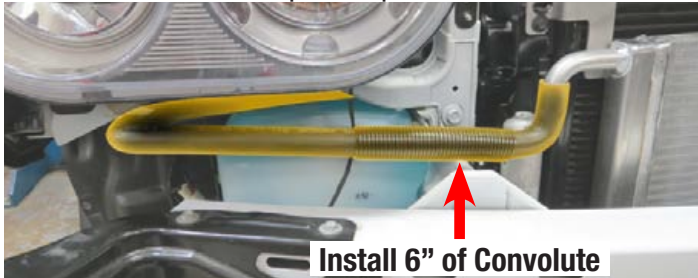

89. Install the LTR to Manifold hose onto the driver side intercooler fitting and secure with a hose clamp from Bag #3. Route the hose down towards the LTR making sure the hose is routed under the A/C lines as shown. **NOTE:** Use caution when routing the hose to ensure it will not contact sharp edges, the exhaust manifold or drive belt pulleys.



90. Attach the LTR to Manifold hose to the LTR and secure with a hose clamp from Bag #3. Apply two (2) pieces of convolute sleeve, about three (3) inches each, to the LTR hose as shown and secure with electrical tape or equivalent.

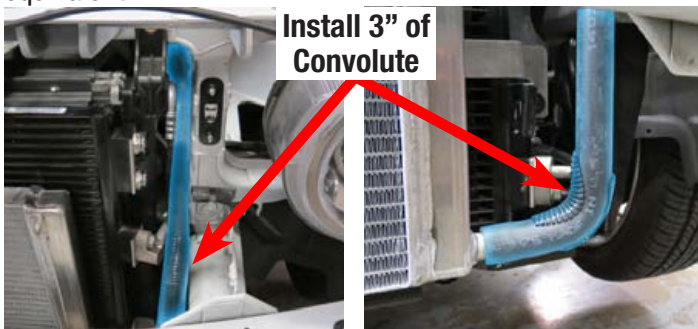

91. Use an 8mm socket to remove the throttle body from the stock manifold then install it on the supercharger manifold using the supplied O-ring seal and four (4) M6 x 40mm bolts from Bag #1.



92. Reconnect the factory throttle body connector to the throttle body. 6.4L vehicles must use the supplied throttle body harness extension as the factory harness is too short.

93. Replace the factory air filter with the supplied green air filter. Using the factory airbox mounting hardware, reinstall the factory airbox.

94. Install the silicone elbow onto the throttle body and the airbox and secure with the supplied warm clamps. airbox.



95. Install the driver side PCV hose onto the fitting next to the oil fill cap and then to the PCV fitting on the airbox.

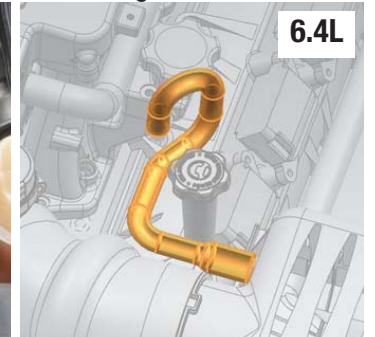



Edelbrock E-Force Supercharger System 2011-'13 Dodge/Chrysler 5.7L and 6.4L Hemi

Installation Instructions

96. Connect the supplied MAP extension harness onto the factory MAP connector, then connect the MAP extension harness to the MAP sensor located on the rear driver side of the manifold.



97. Connect the IAT extension harness to the stock IAT connector. Route the IAT extension harness behind the manifold and connect to the IAT sensor located on the rear passenger side of the manifold.



NOTE: Steps 98-100 are for vehicles equipped with the fuse box shown below. Disregard and proceed to Step 101 if vehicle is equipped with a different fuse box.



98. Open the fuse box and remove the fuse from location 6 (Ignition Coils/Injection 25A - See reverse of fuse box cover), this will be the front most fuse on most applications. Install that fuse in the bottom slot of the supplied fuse tap and the supplied 10 amp fuse in the top slot. Install the fuse tap in the slot previously occupied by the stock fuse.



99. Use a 1/8" drill bit to drill a hole in the plastic rivet closest to the passenger side strut tower. Feed the bare wire extending from the water pump harness through the hole and insert it into the butt connector on the fuse tap. Crimp the butt connector firmly to secure the connection.

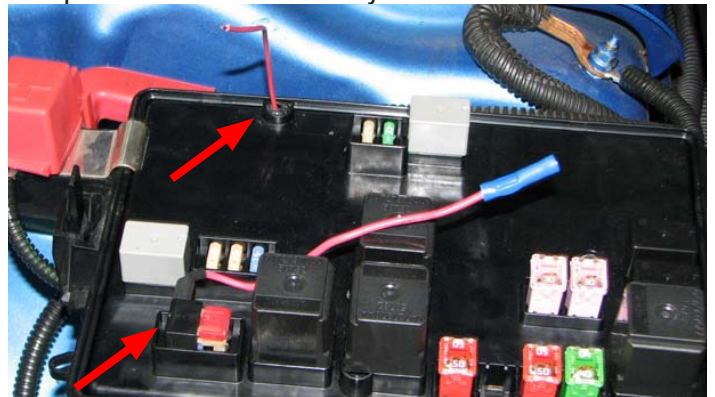

100. Tilt the fuse box up and remove the right nut. Mount the water pump harness relay on the protruding stud and reinstall the nut. Proceed to Step 104.





Edelbrock E-Force Supercharger System 2011-'13 Dodge/Chrysler 5.7L and 6.4L Hemi

Installation Instructions

NOTE: Steps 101-103 are for vehicles equipped with the fuse box shown below. Disregard and proceed to Step 104 if vehicle is equipped with a different fuse box.



101. Open the fuse box and remove the fuse from location 39 (Power Steering / AC Clutch 10A - See reverse of fuse box cover). Install both supplied 10 amp fuses in the fuse tap. Install the fuse tap in the slot previously occupied by the stock fuse.



102. Feed the fuse tap wire on the Water Pump harness through the opening of the fuse box as shown. Using crimpers, connect the fuse tap wire to the butt connector installed on the fuse tap.

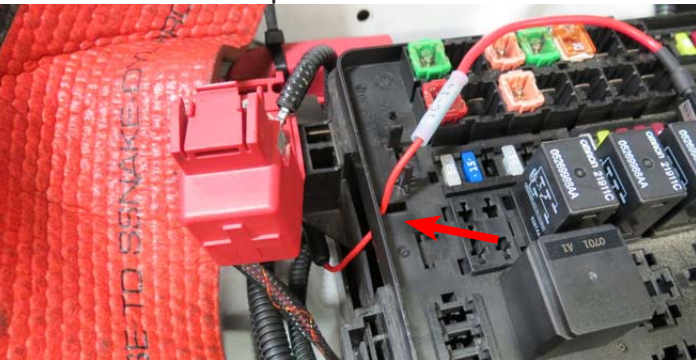

103. Mount the relay and fuse holder on the water pump harness on the metal tab with a wire tie.

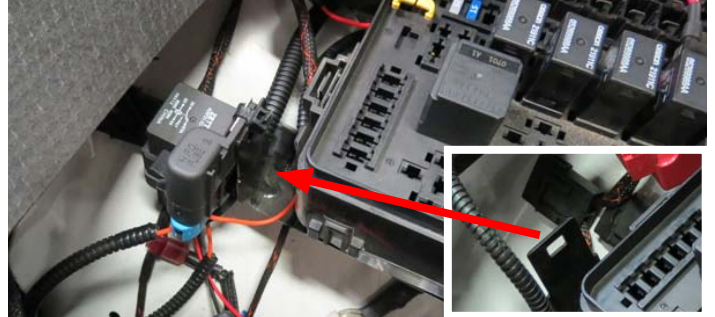

104. Route the water pump connector down to the electric water pump and connect it to the water pump.

105. Route the Power (+) wire on the water pump harness over to the power stud on the fuse box. Remove the nut, slide the ring connector over the stud and reinstall the nut. Route the Ground (-) wire on the water pump harness over to the grounding stud on the passenger side strut tower. Remove the nut, slide the ring connector over the stud and reinstall the nut.

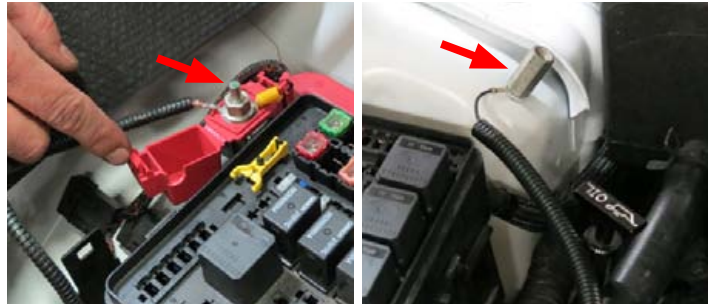

106. Remove the intercooler reservoir cap and fill the system with a 50/50 blend of water and antifreeze.



Edelbrock E-Force Supercharger System 2011-'13 Dodge/Chrysler 5.7L and 6.4L Hemi

Installation Instructions

107. Using a 1/4" hex, remove the coolant bleeder screw. Apply thread sealant to the threads of the bleeder screw and set aside. Fill the cooling system with appropriate 50/50 blend of coolant until coolant leaks out of the bleeder hole. Immediately replace the bleed screw and tighten. Continue filling the coolant reservoir until the level reaches the Cold Fill level.



108. Vehicles with power steering cooler that installed an extension hose should check fluid levels and refill if necessary.

If you have yet to flash your ECU, then proceed with Steps 109-123, otherwise disregard them and skip to Step 124.

109. Verify that your vehicle's ECU is up to date.

Original Equipment Manufacturers often release updates to the computer programming for your vehicle. Edelbrock highly recommends that you verify, with your new car dealer, that your vehicle is equipped with the latest software version from your vehicle's manufacturer before attempting to load the Edelbrock tune.

110. Verify that the programmer is up to date by connecting it to your PC using the supplied USB cable. Please see the Quick Reference Guide included with your Diablo inTune programmer for more details.

111. Confirm that your programmer has the latest calibration by checking the Edelbrock website (http://www.edelbrock.com/automotive_new/mc/superchargers/software-tech.shtml).

112. Once you have found the latest tune on the website, power on the programmer by connecting it to the USB port on your computer, then select SETTINGS and confirm your selection.

NOTE: If you get the message on your InTune programmer that reads: "This vehicle needs an update Download here: www.diablosport.com/dcx.", this is because the programmer needs to update the vehicle's stock calibration file because the vehicle currently has an older calibration that is not supported by the programmer, this does not mean that the programmer itself needs an update.

Please go to www.diablosport.com/dcx and it will instruct you how to update the calibration for your vehicle.

113. Select TOOL INFO then select FIRMWARE INFO. Verify that the Edelbrock calibration file is the same as the version on the website. If they are different, download the new calibration as instructed on the website.

114. Once you have verified that the ECU, Programmer and Calibration are up-to-date, plug the supplied programming module into the OBD-II port of the car, located below the steering column.

115. Put the car into ACC mode, but don't start the vehicle.

116. After the inTune screen loads, select TUNE VEHICLE from the main menu.



117. Select WRITE VEHICLE from the Tuning Menu.





Edelbrock E-Force Supercharger System 2011-'13 Dodge/Chrysler 5.7L and 6.4L Hemi

Installation Instructions

118. When prompted, turn the key to the ON position but do not start the vehicle.

119. Once the vehicle is recognized, select the Edelbrock Tune from the menu.

120. Confirm the selection by pressing the green check icon.

NOTE: The programmer will automatically save a copy of your existing vehicle calibration.

121. You will be asked if you wish to modify the tune. Press the green check icon to make specific modifications (tire sizes, gears, shift firmness, etc..) or press the red X to skip this step.

NOTE: If modifying tire sizes, you will need to check your tire manufacturer's website to determine the tire revolutions per mile for your tires.

122. The selected tune will now be written to your vehicle. This process can take several minutes.

NOTE: If this process fails to complete, make sure that the battery is at the proper voltage and retry.

123. When the download is complete you will be prompted to disconnect the Diablo Sport Tuner from the OBD-II port of your vehicle.

124. Start the vehicle and check for any fuel, coolant or power steering fluid leaks (if applicable). If leaks are present, shut the engine off immediately and repair leaks before continuing.

125. Let the engine come up to operating temperature, then shut it off and recheck all fluid levels. Top fluids off as necessary.

NOTE: Step 126 are for vehicles equipped with two piece radiator shrouds. Disregard otherwise.

126. Test fit the radiator shrouds and trim as needed in order to clear the intercooler and power steering cooler hoses. Install radiator shrouds using the factory hardware. Proceed to Step 130.

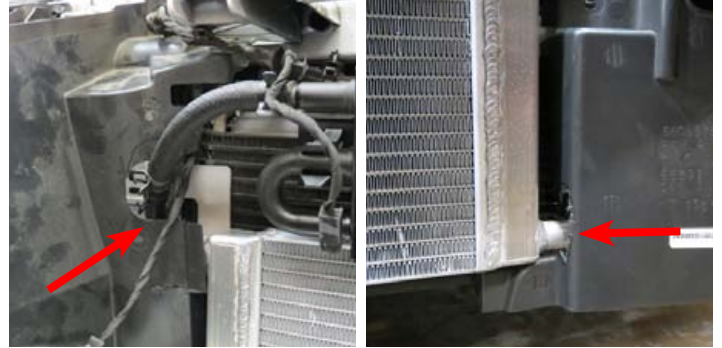

NOTE: Step 127-129 are for vehicles equipped with a front fascia support. Disregard otherwise.

127. Remove both rubber strips from the front fascia support.



128. Using a dremel or equivalent, grind down the lower tab on the passenger side of the front fascia support.





Edelbrock E-Force Supercharger System 2011-'13 Dodge/Chrysler 5.7L and 6.4L Hemi

Installation Instructions

129. Reinstall the front fascia support and the front bumper absorber using the factory hardware.

130. Using a dremel, or equivalent, trim the driver side of the front fascia to clear the LTR hose. Verify that the LTR hose clears the fascia before reinstalling the front fascia.



131. Reinstall the front fascia by reversing the disassembly procedure.

132. Reconnect the lighting harness connectors.

CAUTION: To avoid burning yourself, only perform Step 133 on an engine that is cool to the touch.

NOTE: Oil cap must be removed temporarily to complete Step 133. Make sure to cover the oil fill with a rag to prevent foreign objects from falling into the oil fill hole.

133. Assemble the grommets and coil cover brackets supplied in Bag #6 then mount the brackets to the underside of the tabs on the supercharger lid. The flat brackets go on the rear provisions while the offset brackets go up front.



134. Thread the ball studs supplied in Bag #6 into the bosses on the underside of the coil covers, then lower the covers onto the engine so that the ball studs slide into the grommets. It may be necessary to re-clock the hose clamps on the intercooler hoses in order to get a flush fit.



Congratulations on the successful installation of your new Edelbrock E-Force Supercharger System. If you have any questions, please call our Technical Support hotline at 800-416-8628 and one of our technicians will be happy to assist you.





Edelbrock E-Force Supercharger System 2011-'13 Dodge/Chrysler 5.7L and 6.4L Hemi

Installation Instructions

The Fuel Pump replacement procedure is only for 5.7L vehicles. Disregard if your vehicle is not a 5.7L.

NOTE: Before beginning the installation of the supplied fuel pump, make sure the fuel level of the vehicle is below 5/8 of a tank to avoid fuel spillage in vehicle.

The fuel pump module must be installed in the same position as removed. This step must be performed correctly to prevent the float from contacting the side of the fuel tank.

135. Install the supplied fuel pump by removing the rear lower seat cushion. Push the rear lower seat cushion up and back to remove.

136. Fold back the foam pad covering the fuel pump rubber access plug. Remove the rubber access plug using a panel tool and disconnect the electrical connector from the fuel pump module.



NOTE: Prior to removing the fuel pump module, remove any dirt or debris around the fuel tank opening with compressed air or shop vac.

137. Position the lock ring remover/installer (Chrysler #9340) or equivalent into the notches on the outside edge of the lock ring. Attach a 1/2" drive breaker bar to the lock ring remover/installer and rotate the breaker bar counterclockwise to remove.



138. Lift the fuel pump module up to access the lower power connections. Disconnect the connectors from under the top of the fuel pump module and set aside.



139. Press the quick connect release tab on the fuel supply line and remove. Now, disconnect the lower fuel pump module electrical connector and fuel return lines.

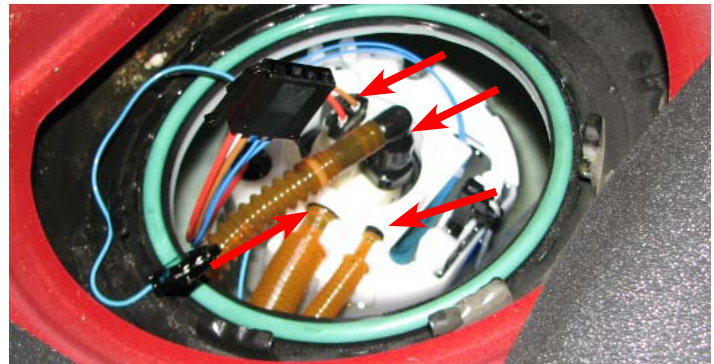

140. Carefully turn the fuel pump module on its side to drain the remaining fuel from the bottom reservoir and remove from the vehicle.

NOTE: An alignment arrow is located on top of the fuel pump module to help align it during installation.

141. Remove the rubber O-ring seal and discard. Replace with the supplied rubber O-ring seal. Then lower the supplied replacement fuel pump module into the fuel tank and connect the fuel return lines.

142. Connect the fuel supply line and lower fuel pump module electrical connector. Now connect the electrical connectors at the top of the fuel pump module and lower the fuel pump module into position.