



# EDELBROCK E-FORCE SUPERCHARGER KITS

Catalog #1551, 15511, 1552, 15521, 1553, 15531,  
1554, 15541, 15611, 15621, 15631, 15641

## INSTALLATION INSTRUCTIONS

**PLEASE** study these instructions carefully before beginning this installation. Most installations can be accomplished with common tools and procedures. However, you should be familiar with and comfortable working on your vehicle. If you do not feel comfortable performing this installation, it is recommended to have the installation completed by a qualified mechanic. If you have any questions, please call our **Technical Hotline at: 1-800-416-8628**, 7:00 am - 5:00 pm, Pacific Standard Time, Monday through Friday or e-mail us at [Edelbrock@Edelbrock.com](mailto:Edelbrock@Edelbrock.com).

**IMPORTANT NOTE: Proper installation is the responsibility of the installer. Improper installation will void your warranty and may result in poor performance and engine or vehicle damage.**

**DESCRIPTION:** Edelbrock E-Force Supercharger kits are designed for 302-400 C.I.D. small-block Chevrolet engines. These kits are capable of producing over 500 HP on most applications. Superchargers will accept standard flange 4-bbl carburetors. Some kits include an 800 CFM Thunder Series AVS carburetor (See "Applications" below). Kit includes all items necessary for installation on most small-block Chevrolet applications. Some modification or aftermarket parts may be required for your particular application such as throttle/kickdown bracketry and cables, waterneck, and accessory pulleys. **Kits will work on LONG-STYLE water pump applications ONLY (unless otherwise mentioned).** Please read "Before Beginning Installation" section for additional details.

### APPLICATIONS:

#### For Small Block Chevrolet Using Stock V-Belt Driven Accessories

- #1551 (As Cast) / 15511 (Polished): Engines with 1986 and earlier (standard bolt-pattern) cylinder heads.
- #1552 (As Cast) / 15521 (Polished): Engines with Vortec/E-Tec style cylinder heads.
- #1553 (As Cast) / 15531 (Polished): Engines with 1986 and earlier (standard bolt-pattern) cylinder heads. Includes carburetor.
- #1554 (As Cast) / 15541 (Polished): Engines with Vortec/E-Tec style cylinder heads. Includes carburetor.

#### For Small Block Chevrolet Using Billet Specialties Tru Trac Pulley System\*\*

- #15611 (Polished): Engines with 1986 and earlier (standard bolt-pattern) cylinder heads.
- #15621 (Polished): Engines with Vortec/E-Tec style cylinder heads.
- #15631 (Polished): Engines with 1986 and earlier (standard bolt-pattern) cylinder heads. Includes carburetor.
- #15641 (Polished): Engines with Vortec/E-Tec style cylinder heads. Includes carburetor.

**\*\*Kits require short-style, reverse-rotation water pump.**

### BEFORE BEGINNING INSTALLATION

**WARNING: EXPOSED FUEL AND OIL WILL BE PRESENT DURING THIS INSTALLATION. WHEN WORKING AROUND GASOLINE OR OIL, ALWAYS WORK IN A WELL VENTILATED AREA, AND KEEP ALL OPEN FLAMES, SPARKS, AND OTHER SOURCES OF IGNITION AWAY FROM THE WORK AREA. FAILURE TO DO SO CAN RESULT IN A FIRE OR EXPLOSION.**

**WARNING: SOME PROCEDURES IN THIS INSTALLATION MAY REQUIRE THE VEHICLE TO BE RAISED ON JACKSTANDS OR A LIFT. WHEN RAISING A VEHICLE, MAKE SURE THE VEHICLE IS ON LEVEL GROUND AND SUPPORTED SECURELY BY JACKSTANDS. NEVER WORK UNDER A VEHICLE THAT IS SUPPORTED BY A JACK ONLY!**

**BEFORE BEGINNING:** Someone who has a basic knowledge of automobile repair and modification and is familiar with and comfortable with working on their vehicle can accomplish the mechanical installation of this kit using common tools and procedures. However, successful operation of the engine with this supercharger kit requires a working knowledge of the set-up and tuning of an engine. Keeping a service manual for your vehicle on hand for reference is helpful. This supercharger kit is capable of supporting over 500 HP and will substantially increase the power output of your engine. **Before installing this kit, you should ensure that your engine is in good condition and is capable of supporting these power levels.** Consult a Factory Service Manual for the proper compression test procedure and acceptable in-service limits. This kit is intended to be used on modified street/strip engines. The required modifications to your engine and fuel delivery system are dependent on the boost pressure and power output. Aftermarket pistons, connecting rods, and valves are recommended to assure engine durability. See "Boost and Ignition Timing" on the next page for further information. The higher power output will require an aftermarket high-volume fuel pump such as Edelbrock #1711 (130 gal/hr), 1721 (110 gal/hr), 17000 (175 gal/hr), 1791 (120 gal/hr, electric), or 1792 (160 gal/hr, electric). The valve lash or lifter preload should be properly adjusted.

## BEFORE BEGINNING INSTALLATION (CONTINUED)

If the valves are not properly seating, or the valve lash is not properly adjusted, the increased temperatures created by the increased power output could accelerate valve seat wear and cause burnt valves. If for any reason your engine has oil pressure that is below the acceptable service limits as specified in the Factory Service Manual, this problem should be corrected before installing this supercharger kit. *Be sure to verify you have all parts listed in the "Kit Contents" section before starting your installation.*

**BOOST AND IGNITION TIMING:** You MUST reset your ignition timing BEFORE driving the vehicle. Supercharged engines require the total timing to be reduced as compared to a stock engine. The general rule of thumb is to retard timing by two degrees (2°) per pound of boost. The E-Force Supercharger kit is designed to produce approximately 5 lbs. of boost under normal conditions. This would indicate that you retard total timing by 10°. Doing so however, can cause hard starting problems unless your advance curve is adjusted in order to allow you to run a normal initial timing setting. Initial timing should be set typically between 10-14° before TDC. Edelbrock recommends the use of a boost dependent timing retard device with the E-Force Supercharger Kit. This will allow you to run a typical advance curve for optimal performance under all conditions, in or out of boost. We recommend a timing controller such as the MSD Boost Timing Master (MSD Part #5462).

**BOOST PRESSURE READINGS:** The E-Force Supercharger Kit is designed and intended to produce approximately 5 lbs. of boost on a street/strip modified 350 C.I.D. small-block Chevrolet engine. Our 9.5:1 compression ratio test engine featured our Performer RPM Hydraulic-Roller Camshaft and E-Tec 200 cylinder heads. Stock and more mildly built engines may see higher boost pressures due to being less able to consume the air flow being provided by the supercharger. As RPMs increase, this effect is more noticeable as pressure builds up in the intake manifold. Higher flowing engines may see less boost pressure due to their ability to use more of the air being pushed into the engine by the supercharger. It is possible to look for this effect by reading boost pressure midway through the engine's operating range (i.e. 3500-4000 rpm), and again at the high end of the operating range (i.e. 5500-6000 rpm). If boost pressure increases significantly as RPM increases, this is an indication of your engine requiring increased breathing capacity in order to use the full potential of the E-Force Supercharger Kit. Ported or aftermarket cylinder heads and a more aggressive camshaft would be recommended. If boost pressure does not increase significantly as you reach the upper end of your operating range, then your engine is breathing adequately for use with the E-Force Supercharger Kit.

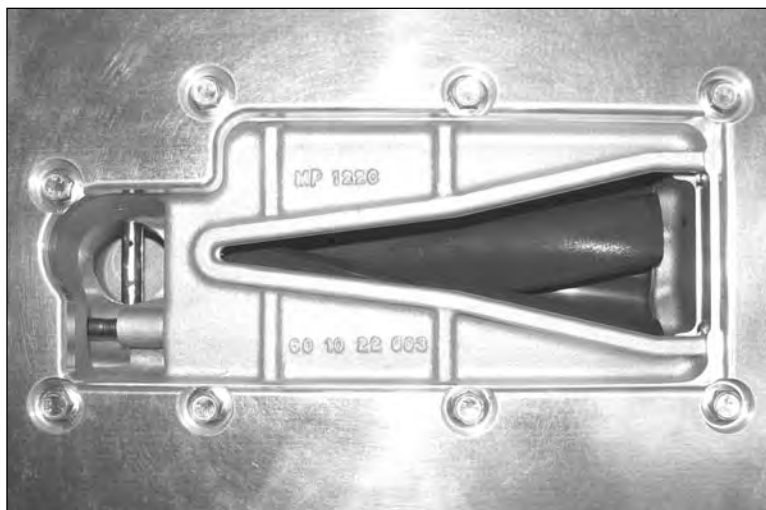
**AFTER INSTALLATION, BEFORE STARTING THE VEHICLE:** We strongly recommend using a colder spark plug in the engine. In our testing, we used Champion RC9YC spark plugs. You may use any manufacturer's plugs that match the correct plug configuration and are two to three heat ranges colder than were used in the naturally aspirated engine. The use of 91 octane fuel (minimum) is required with the use of this E-Force supercharger kit (in typical engines; high compression ratio/strip applications will require higher octane fuel). The increased cylinder pressures created as a result of supercharging can lead to detonation (pinging), if lower grade fuel is used. Also, using exhaust headers and a dual exhaust system with free-flowing mufflers is highly recommended.

### IMPORTANT NOTE

**CAUTION: THE BOLTS ATTACHING THE SUPERCHARGER TO THE INTAKE MANIFOLD TOP PLATE ARE PRE-INSTALLED AND HAVE HAD A THREAD LOCKING COMPOUND APPLIED.**

***DO NOT ATTEMPT TO DISASSEMBLE THE SUPERCHARGER FROM THE TOP PLATE!***

**REMOVING THESE BOLTS AND REINSTALLING THEM CAN RESULT IN THE BOLTS COMING LOOSE DURING ENGINE OPERATION AND POTENTIALLY FALLING INTO AN INTAKE PORT, CAUSING SEVERE ENGINE DAMAGE!**



***SUPERCHARGER TO TOP PLATE BOLTS. DO NOT REMOVE!***

## KIT CONTENTS

### FOR STANDARD V-BELT DRIVE ACCESSORIES

- 1 Supercharger/Manifold Top Plate Assembly
- 1 Supercharger Intake Manifold
- 1 Supercharger Snout Support/Idler Pulley Bracket
- 1 Alternator Support Bracket
- 1 Idler Pulley
- 1 Idler Pulley Spacer
- 1 Idler Pulley Nut
- 1 Crankshaft Supercharger Drive Pulley
- 3 Crankshaft Pulley Shim
- 1 7/16-20 x 2.75" Long, 1.50" Shoulder Bolt (Crankshaft Balancer)
- 3 3/8-24 x 3.75" Long, 2.625" Shoulder Bolt (Crankshaft Pulley)
- 3 3/8-16 x 4" Long, 2.75" Shoulder Bolt (Idler Pulley and Bracket)
- 10 3/8-16 x 1.25" Long Bolt (Intake Manifold)  
*Standard Bolt Pattern Kits Only*
- 2 3/8-16 x 1.75" Long, .625" Shoulder Bolt (Intake Manifold)  
*Standard Bolt Pattern Kits Only*
- 4 5/16-18 x 1.75" Long Bolt (Intake Manifold)  
*Vortec/E-Tec Bolt Pattern Kits Only*
- 4 5/16-18 x 2.5" Long Bolt (Intake Manifold)  
*Vortec/E-Tec Bolt Pattern Kits Only*
- 8 1/4-20 x 1" Long Bolt (Manifold Top Plate to Intake Manifold)
- 4 5/16-18 x 1" Long Bolt (Manifold Top Plate to Intake Manifold)  
*Standard Bolt Pattern Kits Only*
- 3 3/8" I.D. Split-Lock Washer
- 1 7/16" I.D. Split-Lock Washer
- 1 7/16" I.D. x .120 Thick Flat Washer
- 1 Supercharger Drive Belt
- 1 Intake Manifold O-Ring Seal (54" Long)
- 1 Intake Manifold Gaskets (Pair)
- 1 Carburetor Kit (800CFM Thunder Series AVS, Electric Choke)\*\*
- 1 Carburetor Stud, Nut, & Washer Kit\*\*

**\*\*Carburetor and associated hardware included in certain kits ONLY.**  
See "Applications" section for those kits that include carburetor.

### FOR BILLET SPECIALTIES TRU TRAC PULLEY SYSTEM

- 1 Supercharger/Manifold Top Plate Assembly
- 1 Supercharger Intake Manifold
- 10 3/8-16 x 1.25" Long Bolt (Intake Manifold)  
*Standard Bolt Pattern Kits Only*
- 2 3/8-16 x 1.75" Long, .625" Shoulder Bolt (Intake Manifold)  
*Standard Bolt Pattern Kits Only*
- 4 5/16-18 x 1.75" Long Bolt (Intake Manifold)  
*Vortec/E-Tec Bolt Pattern Kits Only*
- 4 5/16-18 x 2.5" Long Bolt (Intake Manifold)  
*Vortec/E-Tec Bolt Pattern Kits Only*
- 8 1/4-20 x 1" Long Bolt (Manifold Top Plate to Intake Manifold)
- 4 5/16-18 x 1" Long Bolt (Manifold Top Plate to Intake Manifold)  
*Standard Bolt Pattern Kits Only*
- 1 Supercharger/Accessory Drive Belt
- 1 Intake Manifold O-Ring Seal (54" Long)
- 1 Intake Manifold Gaskets (Pair)
- 1 Carburetor Kit (800CFM Thunder Series AVS, Electric Choke)\*\*
- 1 Carburetor Stud, Nut, & Washer Kit\*\*

**\*\*Carburetor and associated hardware included in certain kits ONLY.**  
See "Applications" section for those kits that include carburetor.

**IMPORTANT NOTE:** Edelbrock E-Force Supercharger kits do not include the Billet Specialties Tru Trac Pulley System. These systems are available separately from Edelbrock and include a water pump, A/C compressor, alternator, and all the pulleys, brackets, and mounting hardware necessary for a complete installation. These systems can be purchased with a power steering pump as part #1565, or without as part #1566.

## ADDITIONAL PARTS AND TOOLS

### TOOLS AND EQUIPMENT:

- Box and open end wrenches
- Socket set
- Distributor wrench
- Pliers (channel locks and hose clamp)
- Screw drivers (regular and Phillips)
- Torque wrench
- Hammer
- Gasket scraper or putty knife
- Timing light
- Vacuum gauge
- Rags
- Water bucket
- Paper and pencil

### ADDITIONAL PARTS AND SUPPLIES:

- Gaskets-Edelbrock, or performance gasket equivalent
- Pipe plugs, if needed
- Edelbrock Gasgacinch (#9300)
- RTV High Temp silicone sealer or O/2 sensor safe RTV
- Masking tape
- Modeling clay or putty
- Chalk
- Radiator coolant
- Teflon thread tape or PST thread sealer or equivalent
- Thread locking compound such as Loctite™ (Red, Blue, or equivalent)
- Supercharger & Accessory drive belt (for Billet Specialties applications, see installation procedure for recommended part numbers)

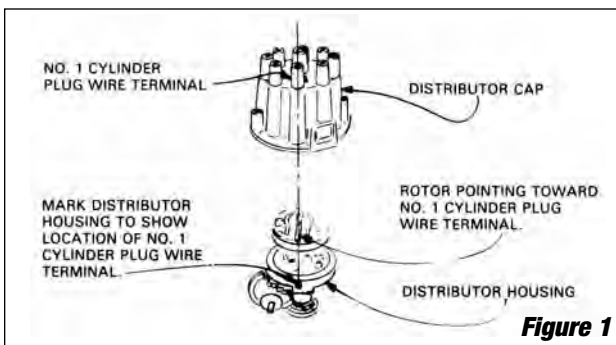
## PARTS REMOVAL AND PREPARATION

1. Make sure vehicle is on level ground, and the wheels are chocked. Disconnect battery.
2. Loosen tension on accessory belts and remove belts. Remove alternator tensioning bracket (upper bracket) from water pump.
3. Remove crankshaft pulley bolts and remove accessory pulley. Remove crankshaft balancer bolt, but do not remove the balancer itself.
4. Drain radiator coolant (drain plug will normally be located on lower right facing engine).
5. Remove radiator hose, thermostat housing and thermostat, if mounted on manifold.
6. Remove gas cap to relieve pressure. Disconnect fuel line from carburetor and plug it. Replace gas cap.
7. Disconnect all linkage from carburetor such as throttle, throttle springs, transmission, cruise control and automatic choke.
8. Make note of locations and tag and remove coil wires, sensor wires, and vacuum lines.
9. Remove all brackets that are on the manifold.
10. Loosen or remove valve cover bolts on valve covers for manifold removal and replacement. It may be necessary to replace valve cover gaskets, if broken, to prevent oil leakage.

### 11. REMOVING IGNITION:

**CAUTION:** Follow instructions carefully, as serious damage can occur when ignition is not removed and reinstalled correctly.

- A. Remove distributor cap.
- B. Note position of rotor and make a mark on the distributor case in line with the rotor point.
- C. Note position of distributor vacuum canister and place one type of mark on valve cover or firewall in line with the vacuum outlet. This will be used as a reference. However, you may have to re-align the distributor to clear the supercharger after installation.
- D. Note position of points (or magnetic trigger wheel), if open, how much; if closed, note the distance from point block to cam lobe (**See Figure 1**).



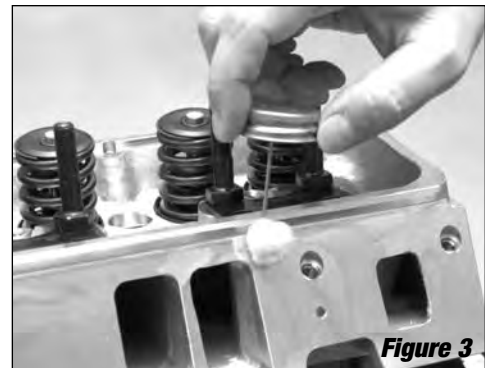
- E. Remove distributor. **Do not rotate engine after removing distributor.**

12. Remove Intake Manifold bolts and remove intake manifold.

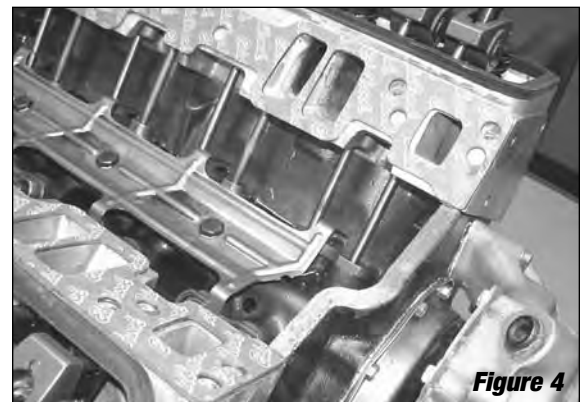
### 13. GASKET SURFACE PREPARATION:

**NOTE:** This is a **MUST** to ensure proper sealing. Use supplied gaskets only.

- A. **THOROUGHLY clean intake manifold bolt holes and cylinder head flanges and end seal surfaces of all remaining gasket material and sealer.** To prevent gasket pieces from falling into ports and combustion chambers when cleaning old gaskets from head surfaces, lay rags in lifter galley and stuff paper towels or rags into ports. When clean, remove stuffing carefully making sure all particles fall on rags in lifter galley. Carefully remove rags containing particles. Wipe gasket surfaces clean with rags using lacquer thinner to remove any oil or grease.  
**NOTE:** Check gaskets on head surface and manifold to make sure they are correct. Beaded side faces up.
- B. Coat head surface and cylinder head side of intake gaskets with Edelbrock Gasgacinch #9300 (**See Figure 3**).



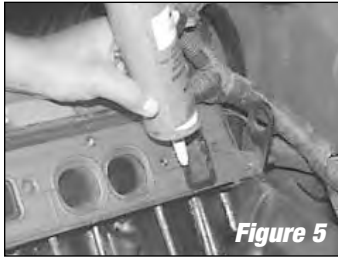
14. Within a few minutes gaskets and surface will become tacky to the touch. Carefully place gaskets on head surface, aligning ports and bolt holes (**See Figure 4**). See instructions on gasket package for further details.



## INSTALLATION PROCEDURE

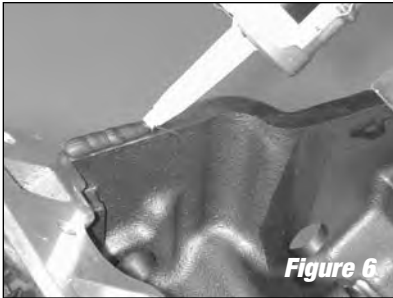
1. With the intake gaskets in place, apply a small amount of RTV High Temp silicone sealer around the water passages on the intake manifold side **(See Figure 5)**.

**NOTE:** If you are using an air/fuel ratio meter (O2 sensor) on your vehicle, use O2 sensor safe silicone ONLY.



**Figure 5**

2. With the Edelbrock intake manifold, you must use RTV High Temp silicone sealer instead of end seal gaskets. Apply a 1/4" thick bead of sealant across each end seal surface **(See Figure 6)**.

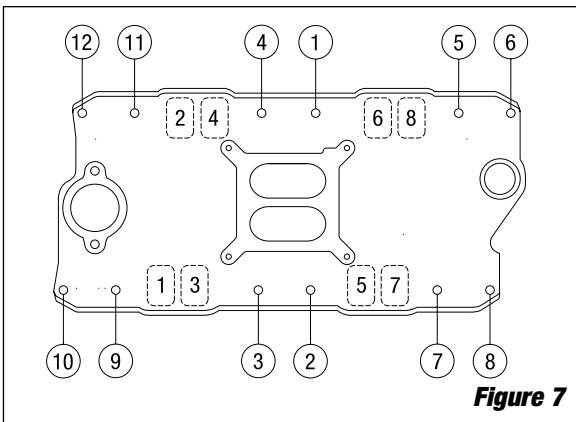


**Figure 6**

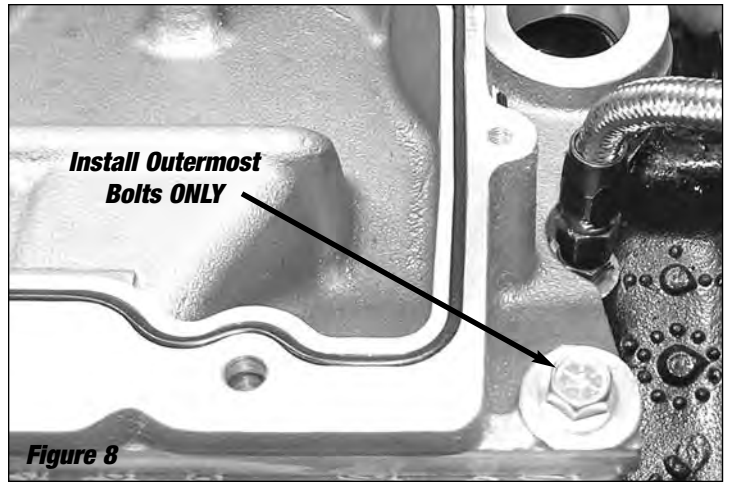
3. Carefully install the intake manifold onto the engine, making sure the ports and bolt holes line up with the gasket. For 1986 and earlier applications, you may install the intake manifold bolts.

**NOTE:** You **MUST** use Loctite™ (Red #242, Blue #271, or equivalent thread locking compound) on bolts located under the supercharger top plate. This will prevent the possibility of bolts backing out and falling into the intake manifold, resulting in severe engine damage. Make sure to clean bolt threads and bolt hole threads prior to applying thread locking compound.

Torque bolts to 25 ft./lbs. Follow the sequence shown in **Figure 7**. For E-Tec/Vortec applications, install the four (4) outermost bolts **ONLY**, and **DO NOT TIGHTEN**. Snug these bolts by hand with a small box-end wrench. This will keep the manifold steady while installing the supercharger and manifold top plate assembly **(See Figure 8)**.



**Figure 7**



**Figure 8**

4. Install the provided length of O-Ring Seal into the groove on the intake manifold. Take care not to stretch the seal as you place it into the groove. This will cause the ends to separate over time and can cause a vacuum/boost leak. Trim the seal carefully so that the ends butt against each other neatly. Apply a dab of RTV silicone where the ends of the seal meet **(See Figure 9)**.



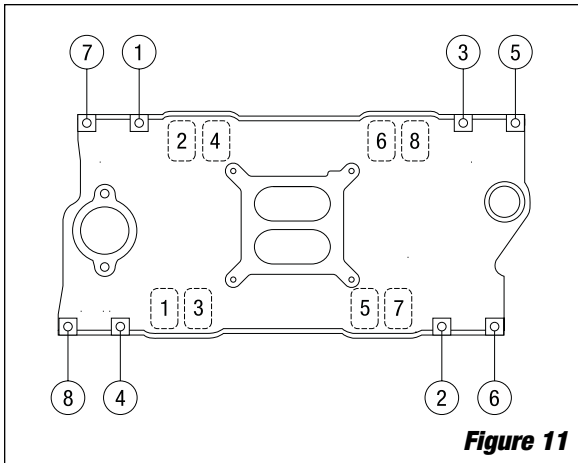
**Figure 9**

5. Carefully place the supercharger and manifold top plate assembly onto the intake manifold **(See Figure 10)**.

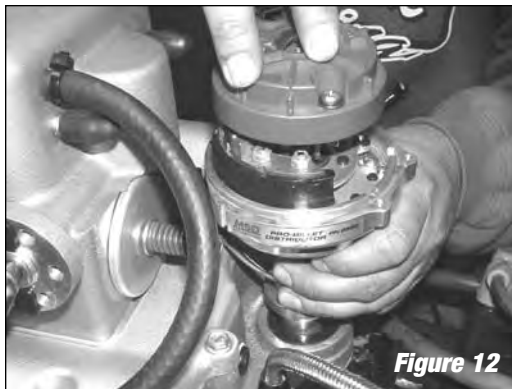


**Figure 10**

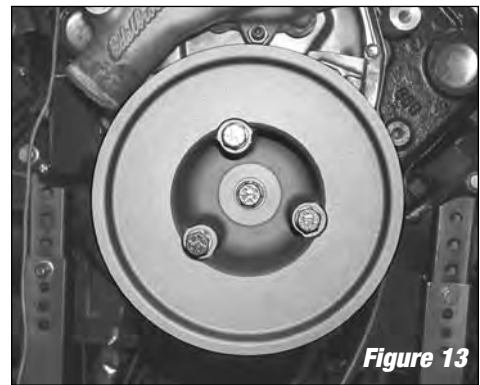
6. For 1986 and earlier applications, install the top plate to intake manifold bolts and torque bolts to 8-10 ft./lbs. On E-Tec/Vortec applications, install the top plate to manifold bolts and snug down with a small box end wrench. You may now install the remaining four (4) intake manifold bolts (that pass through the top plate) and tighten all of the manifold bolts to 11 ft./lbs by the sequence shown in **Figure 11**. Then torque the remaining top plate to manifold bolts to 8-10 ft./lbs. Tighten bolts in a criss-cross pattern, starting in the center and working outward.



7. Place a clean rag over the carburetor opening in the supercharger to prevent any debris from entering during the remainder of the installation.
8. Reinstall the distributor (**See Figure 12**). Make sure the distributor is aligned in the same position, with the rotor pointing to the same terminal as it was when the distributor was removed. You may need to lift and reinsert the distributor multiple times to align the rotor.

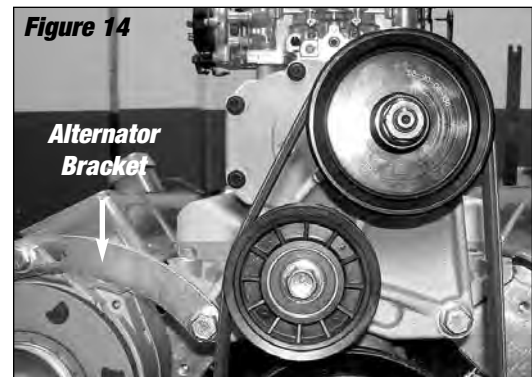


9. Install supercharger drive pulley in front of the factory accessory crank pulley using the supplied 3/8-24 x 3.75" long shoulder bolts and 3/8" lock washers (**See Figure 13**). Install the supplied 7/16-20 x 2.75" balancer bolt with a 7/16" lock washer first and snug the bolt down until the pulley is flush. Do not fully tighten at this time. Slip the drive belt over the top and bottom pulleys, and make sure the pulleys are in-line. If they are not aligned, remove the drive belt and pulley from the crankshaft and use the provided shims to align the pulley. Once properly aligned, torque the balancer bolt to 60 ft./lbs., and torque the pulley bolts to 32-35 ft./lbs. You may leave the drive belt uninstalled at this time.

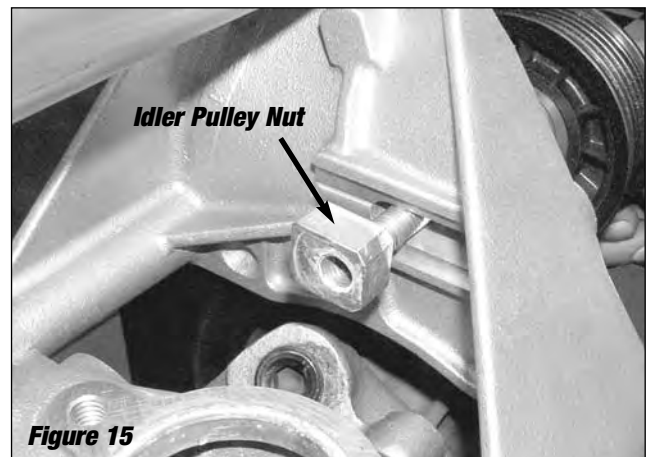


**10. Install the supercharger snout support/idler pulley bracket:**

- A. For standard pulley applications, you will attach the bracket to the front of the intake manifold using two (2) of the 3/8-16 x 4" long x 2.75" shoulder bolts (**See Figure 14**). Install the Alternator Tensioning bracket under the passenger side bolt (**See Figure 14**). Align the tensioning bracket with the alternator and tighten the snout support/idler pulley bracket bolts. Install the alternator tensioning bolt, but do not tighten at this time.

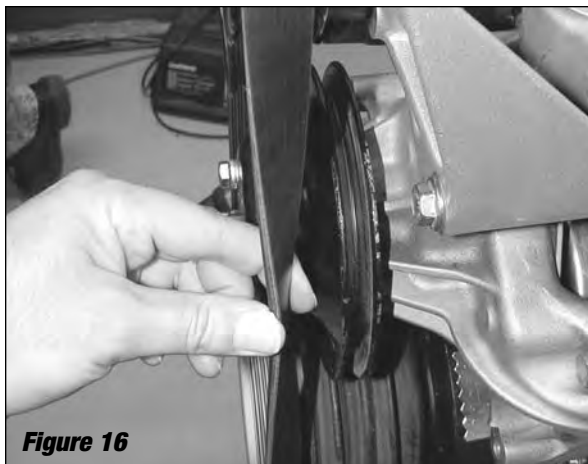


- B. Install the idler pulley onto the bracket. Use the remaining 3/8-16 x 4" long x 2.75" shoulder bolt, idler pulley spacer, and square idler pulley nut to attach the idler pulley to the bracket (**See Figure 15**). Make sure the nut is aligned with the slot on the back of the bracket.



## 11. Supercharger and Accessory Drive Belts:

- A. Standard drive kits will require you to install your accessory drive belts prior to installing the supercharger drive belt. Reinstall any bracketry that was attached to the intake manifold, replace accessory belts, and adjust tension on your accessories. Tighten all accessory bolts.
- B. Install the supercharger drive belt. Adjust tension on the belt by sliding the idler pulley along the slot in the idler pulley bracket. When proper tension is attained, you should only be able to twist the belt 90 degrees using your thumb and forefinger (**See Figure 16**).



**Figure 16**

12. Remove the rag covering the supercharger inlet, and install your carburetor. For kits including an Edelbrock carburetor, use the provided carburetor studs/nuts/washers. Connect your fuel line to the carburetor at this time.
13. Connect your throttle linkage. Remember, the factory throttle cable bracket will not work with the supercharger kit. A bracket designed to attach to the rear of the carburetor is recommended. Reinstall your air cleaner assembly.
14. Move any sensors from the stock intake manifold to the Edelbrock intake manifold, and connect any wires. Connect vacuum lines, replacing with longer or shorter vacuum hoses as required.
15. Reinstall valve covers. Replace gaskets if necessary.
16. Reinstall the radiator hoses, thermostat, and thermostat housing.

**NOTE:** Some applications may require using a different thermostat housing to clear the supercharger snout. This may also require using a different upper radiator hose.

17. Replace spark plugs with the recommended heat range and reconnect all ignition and spark plug wires. Make sure the spark plug wires are installed in the proper order, and that the rotor in the distributor is pointing to the same location on the distributor housing as it was when it was removed. This should have been noted as described in the "Parts Removal and Preparation" section.
18. Top off all fluids to the appropriate factory recommended levels. Check for leaks. Fix any leaks before starting your engine.
19. Reconnect the battery.
20. Start engine and allow to idle. While engine is coming up to operating temperature, set ignition timing as described in the "Before Beginning Installation" section, and check for leaks. If a leak is found, shut off engine and fix leak before continuing engine operation. If no leaks are found, allow engine to come up to operating temperature.

## AFTER INSTALLATION (TUNING)

**CARBURETOR TUNING:** If using a kit supplied with an Edelbrock carburetor, then the carburetor is tuned for use with this supercharger, and limited (if any) adjustment is required. If any adjustment is needed, such as idle speed or idle mixture settings, see the included carburetor owner's manual for proper procedures. If you are using a non-Edelbrock carburetor, proper tuning will be required. See your carburetor owner's manual for procedures. If you are not experienced, or not comfortable with carburetor tuning, please see a qualified mechanic.

**BOOST AND IGNITION TIMING:** You MUST reset your ignition timing BEFORE driving the vehicle. Supercharged engines require the total timing to be reduced as compared to a stock engine. The general rule of thumb is to retard timing by two degrees (2°) per pound of boost. The E-Force Supercharger kit is designed to produce approximately 5 lbs. of boost under normal conditions. This would indicate that you retard total timing by 10°. Doing so however, can cause hard starting problems unless your advance curve is adjusted in order to allow you to run a normal initial timing setting. Initial timing should be set typically between 10-14° before TDC. Edelbrock recommends the use of a boost dependent timing retard device with the E-Force Supercharger Kit. This will allow you to run a typical advance curve for optimal performance under all conditions, in or out of boost. We recommend a timing controller such as the MSD Boost Timing Master (MSD Part #5462).

**FUEL REQUIREMENT:** The use of 91 octane fuel (minimum) is required with the use of this E-Force supercharger kit (in typical engines; high compression ratio/strip applications will require higher octane fuel). The increased cylinder pressures created as a result of supercharging can lead to detonation (pinging), if lower grade fuel is used.



**Edelbrock Corporation • 2700 California St. • Torrance, CA 90503**  
**Tech-Line: 1-800-416-8628 • E-Mail: Edelbrock@Edelbrock.com**