

2001-2003 HONDA CIVIC NITROUS SYSTEM

Catalog #71002

Table of Contents

	Page #
a. Edelbrock General Warranty	2
b. Before You Install Your Edelbrock Nitrous System	3
c. What is Nitrous Oxide?	4
d. Safety Tips for Working with Nitrous Oxide	4
1.0 Introduction to the Edelbrock Nitrous Systems Kit	
1.1 General Information	5
1.2 Jet Map Information	6
1.3 Engine Operation Considerations	6
1.4 Performer Nitrous System Bill of Materials	7
2.0 Nitrous System Installation	
2.1 Nitrous Bottle Mounting	8
2.2 Bottle Orientation	9
2.3 Nitrous Bottle Installation	10
2.4 Nitrous Feed Line Mounting	11
2.5 Solenoid Mounting	11
2.6 Nozzle Installation	12-13
2.7 Fuel Line Installation	14
3.0 Electrical System Installation	
3.1 Nitrous Electrical Components Bill of Materials	15
3.2 Nitrous Electrical System Wiring Diagram	16
3.3 Nitrous Electrical System Installation Procedures	17
3.4 Nitrous Relay and Fuse Holder Installation	17
3.5 Arming Switch and Installation	18
3.6 Microswitch Installation and Wiring	18-19
3.7 Final Electrical Installation Recommendations	19
4.0 Before You Run Your Vehicle Using Your Edelbrock Nitrous System	
4.1 Fuel System Check	20
4.2 Nitrous System Check	20
5.0 Solenoid Inspection and Maintenance	21
6.0 Troubleshooting Guide	22-23

2001-2003 HONDA CIVIC NITROUS SYSTEM

Catalog #71002

Thank You....

...for purchasing an Edelbrock Nitrous Oxide Injection System.

Nitrous Oxide injection is one of the most exciting performance enhancements, for the dollar invested, on the market today. With the use of nitrous oxide come some important safety considerations. This manual has been written to help you during the installation and use of your Edelbrock Nitrous System. Please read it completely before you install and use your system. Please pay close attention to the safety information at the beginning of each section. The information contained there specifically pertains to each of the components and installation methodologies within the section.

Please take the time to read and understand the following....

By installing your Edelbrock Nitrous System, you indicate you have read this document and you agree with the terms stated below:

It is the responsibility of the purchaser to follow all installation instruction guidelines and safety procedures supplied with the Edelbrock Nitrous Systems. It is also the responsibility of the purchaser to determine the compatibility of the product with the vehicle or the device on which the purchaser intends to install it.

Edelbrock Corporation assumes no responsibility for damages occurring from misuse, abuse, improper installation, improper operation, lack of responsible care, or all previously-stated reasons resulting from incompatibility with other manufacturer's products and/or systems.

Edelbrock Corporation neither recommends nor condones the use of products manufactured or sold by Edelbrock Corporation for use on vehicles, which may be driven on public roads or highways, and assumes no responsibility for damages incurred by such use.

Edelbrock Corporation assumes no responsibility for damages incurred by the use of products manufactured or sold by Edelbrock Corporation on vehicles used for competition or racing.

Edelbrock General Warranty

It is the constant endeavor of Edelbrock Corporation to give our customers the highest quality products obtainable. Edelbrock warrants each new product, except Performer Series Carburetors, Race Division Parts, Tubular Exhaust Systems, RPM Series Mufflers, Cat-Back Systems and Performer IAS Shock Absorbers which are warranted separately, to be free from defects in both workmanship and material for a period of one (1) year from the date of purchase, provided that the product is properly installed, subjected to normal use and service and that the product is not modified or changed in any way, negligence by customer or installer or used for racing or competition purposes.

Our warranty service and repair facility is located at 2700 California Street, Torrance, California 90503. Customers who believe they have a defective product should either return it to the dealer from which it was purchased or ship it directly to Edelbrock along with proof of purchase and a complete description of the problem. The product must be returned freight pre-paid. If a thorough inspection of the product by the factory indicates defects in workmanship or material, our sole obligation shall be to repair or replace the product. Warranty covers only the product itself and not the cost of installation or removal.

Edelbrock Corporation shall not be liable for any and all consequential damages occasioned by the breach of any written or implied warranty pertaining to this sale in excess of the purchase price of the product sold.

If you have any questions regarding a product or installation, please contact our Technical Department, toll-free at 1-800-416-8628 from 7:00am to 5:00pm PST, Monday through Friday.

Thank you again for choosing Edelbrock Nitrous Systems.

Caution!!

Before You Install Your Edelbrock Nitrous System...

Please read this Installation manual fully before installing this system.

You will need to have available the following tools:

Hand Tools:

- Socket set including ratchets and extensions
- Screwdrivers
- Pliers
- Bench vise
- Wire crimping pliers, wire strippers
- Floor jack
- Razor blade or other sharp, flat edged cutting instrument
- Vehicle jackstands
- Safety glasses

Power Tools:

- Power drill
- Drill bits

You should understand the following skills:

- Power tool safety procedures
- Undercar safety procedures
- Proper measuring techniques
- Proper electrical assembly techniques
- Basic engine operation and tuning techniques



Anytime you have questions or concerns with your Edelbrock Nitrous System, please call our
Technical Support Hotline at 1-800-416-8628
before you start your engine.

WHAT IS NITROUS OXIDE?

Nitrous Oxide is a cryogenic gas composed of nitrogen and oxygen molecules. It is stored as a “gas over a liquid” which means that both liquid and gaseous nitrous oxide is delivered into your engine. It is 36% oxygen by weight, which is what produces the added horsepower. By injecting more oxygen (and a corresponding fuel signal), we create the additional power much like a supercharger or a turbocharger does.

Nitrous Oxide is considered an “oxidizer” and not a fuel. Nitrous oxide is non-flammable by itself. Because nitrous oxide is a cryogenic, the same safety methods in handling dry ice apply to nitrous. Direct contact with the skin will cause a burn similar to contact with dry ice. The exception in using nitrous oxide comes from increased breathing hazards associated with the gaseous properties of nitrous oxide.

Nitrous Oxide is offered for sale in two common grades, which are U.S.P., and *Nytrous Plus*. U.S.P. nitrous oxide is medical grade nitrous oxide. Its common use is dental and veterinary anesthesia as well as use as a propellant in food such as canned whip cream. U.S.P. is not available to the public and would provide no advantage in the making of horsepower over the automotive grade nitrous oxide.

Nytrous Plus was specifically designed for automotive consumption and differs from U.S.P. in that it contains trace amounts of sulfur dioxide (100 parts per million or “PPM”) added to prevent substance abuse. The Sulfur Dioxide is an irritant to all of your breathing passageways and will cause sore throats and sore nasal passages. *Nytrous Plus* was specifically created for automotive applications and is available for sale to the public at many speed shops across the USA.

Safety Steps For Working With Nitrous Oxide

1. Never inhale *Nytrous Plus* (Nitrous oxide (N₂O) for vehicular use) as continued exposure can cause **death**. *Nytrous Plus* has a maximum of 100 parts per million (ppm) of sulfur dioxide and will cause irritation to nose and throat passageways.
2. When working around any high-pressure gas including nitrous oxide, take all precautions to ensure that exposure to nitrous oxide is minimized.
3. **Do not** vent nitrous oxide to atmosphere in confined spaces. Only vent nitrous oxide in well-ventilated and open areas.
4. Liquid nitrous oxide **can cause burns to human flesh** so protect all skin in and around your hands, arms and face. Wear safety glasses and rubber gloves to protect from liquid nitrous oxide splatter.
5. When venting down the nitrous system, vent the line down closest to the nitrous bottle.
6. **Do not** use any form of Teflon tape as sealant on fitting connections. **Use only Teflon paste.**
7. When washing components, ensure the clean components are completely dry, free of oils, and solvents. Failure to remove all liquids could cause component or system failure.
8. Always turn the bottle off before making any repairs to the nitrous delivery system.
9. To safely release nitrous oxide in a pressurized line;
 - a. Position vehicle in a well-ventilated, unconfined space.
 - b. Turn bottle off.
 - c. Slowly loosen the nitrous feed line at the bottle until you hear a light hissing noise.
 - d. Allow the entire nitrous pressure to vent from the line.
 - e. Perform your work on the system.
 - f. Tighten the nitrous line to the bottle.
 - g. Slowly open the nitrous bottle valve, listening for leaks.
 - h. Perform leak checks on all affected fittings and the bottle fitting.

1.0 Introduction to your Edelbrock Honda Civic Nitrous System

Within the pages of this manual is information, safety tips and operation instructions for your new Edelbrock Nitrous System. Watch for these symbols to know where to go for information.

There is safety related information here.



....shows where technical information about your vehicle or specific skills that may help during installation.



....call Edelbrock Technical support hotline for more information.

1.1 General Information

The Edelbrock 2001-2003 Honda Civic Nitrous System (Part Number 71002) is designed for 2001-2003 Honda Civic vehicles (excluding 2003 Civic Si) equipped with stock or slightly modified 1.7L engines that utilize the returnless style fuel system. Horsepower and torque increases can vary with equipment upgrades and modifications.

The system utilizes one “wet” style nozzle that is installed in the intake boot just after the Mass Air Flow (MAF) {if equipped} sensor filter and before the throttle body. This nozzle delivers the precise amount of nitrous and additional fuel needed to make the correct horsepower gain.

This system has been designed with some flexibility as to where certain components can be located to allow easy installation on vehicles with upgraded or modified equipment . The solenoid and microswitch brackets are designed to be manipulated (bent, cut, twisted, etc.) and the electrical components have properly sized and ample lengths of wire.

This system includes the bottle (shipped empty), bottle feed line and universal footprint steel bottle brackets. The mounting brackets also include rubber insulators to protect the surface of your nitrous bottle while mounted in the brackets. When installing your nitrous bottle, pay close attention to the installation instructions for the location of your bottle. Make sure that the installation of your bottle does not interfere with any systems that may lie under the location where you plan to drill holes for mounting the brackets.

Contact your local automotive store, motorcycle shop or race track for refilling of your bottle. Trust a professional to properly fill your bottle and reference your installation manual when re-installing your filled bottle back into your vehicle.

Always take care when handling a full bottle of nitrous oxide. Please reference this manual for further safety measures to take during the handling of a nitrous oxide bottle.

Please follow all safety methods during the installation of your Edelbrock Nitrous System, and follow all vehicle regulations and road laws when using your nitrous system.

1.2 Jet Map Information

Edelbrock Engineering has conducted dyno testing with the Edelbrock 2001-2003 Honda Civic Nitrous System to ensure the horsepower increase with the nitrous system is as intended. On a typically stock 1.7L Civic engine, you can expect the following approximate power gain:

<u>Nitrous Jetting</u>	<u>Fuel Jetting</u>	<u>Approx. HP Gains</u>	<u>Final Air/Fuel Ratio</u>
.026	.024	40hp	12.5:1
.028	.025	60hp	12.8:1

The dyno tests were conducted at Edelbrock using a stock 1.7L engine. These tests were conducted with 950 psi nitrous bottle pressure.

1.3 Engine Operation Considerations

When used correctly, nitrous oxide safely elevates cylinder pressures and temperatures while increasing combustion rate. These characteristics make the engine more sensitive to detonation. To ensure proper performance, engine and drive line life, the following tips are suggested:

- **System Jetting**

Never exceed the recommended jetting!!! Excessive jetting will result in severe engine damage.

- **Fuel Quality**

Because Nitrous oxide is an oxidizer, fuel selection is critical. Both octane and fuel consistency affect fuel burn rate. The oxidizer quality of nitrous oxide will accelerate the burn rate, so we recommend a high quality of gasoline. We also recommend you use the same grade of gasoline every time you use your nitrous oxide system. This will help maintain the same fuel burn rate every time.

- **Ignition Components**

Most aftermarket performance chips increase the vehicle's ignition timing, which can cause detonation with the use of nitrous oxide. Please consult with your chip manufacturer on information regarding the compatibility of your chip with nitrous oxide use.

If your vehicle is equipped with platinum type spark plugs, we highly recommend they be removed and replaced with the equivalent standard type spark plug.

- **Engine System Upgrades**

With all performance modifications, complementary system upgrades will always serve to elevate the consistency and longevity of an engine, especially when using nitrous oxide as a power adder. Modifications such as ignition upgrades, free-flowing exhaust, camshafts, cylinder heads, manifolds can all add to the performance of a nitrous oxide injected engine.

1.4 Performer Kit Bill of Materials



Qty.	Description	Qty.	Description
<u>Nozzle and Nozzle Hardware</u>		<u>Jets</u>	
1 ea.	E1 Nozzle	1 ea.	Jet .024
1 ea.	E1 Nozzle Bulkhead Body Bolt	1 ea.	Jet .025
1 ea.	E1 Nozzle Bulkhead Concave Nut	1 ea.	Jet .026
		1 ea.	Jet .028
<u>Solenoids and Solenoid Hardware</u>		<u>Fuel System and Hardware</u>	
1 ea.	Performer Nitrous Solenoid	1 ea.	5ft. Length ¼" Fuel Hose
1 ea.	Performer Fuel Solenoid	1 ea.	¼" Barb Tee
2 ea.	Solenoid Mounting Brackets	1 ea.	1/8"NPT x ¼" Barb Fitting
4 ea.	Solenoid Mounting Screws (8 x 32 UNC x 5/16")	4 ea.	Fuel Hose Clamps
1 ea.	N2O Filter Fitting, 4AN x 1/8" NPT, Blue		
1 ea.	3AN x 1/8" NPT Nitrous Fitting, Blue	<u>Bottle and Bottle Hardware</u>	
1 ea.	3AN x 1/8" NPT Fuel Fitting, Red	1 ea.	10-lb., Nitrous Bottle
1 ea.	Microswitch Mounting Bracket	1 pr.	Nitrous Bottle Bracket Set (1 Tall, 1 Short)
1 ea.	15" 3AN Steel Braided Hose 90°, Blue	1 ea.	660 Bottle Nut and Teflon Washer
1 ea.	15" 3AN Steel Braided Hose 90°, Red	1 ea.	14' Nitrous Feed Line, Bottle to Solenoid
<u>Electrical System Components</u>			
1 ea.	Electrical Wiring Pack		

2.0 Nitrous System Installation

2.1 Nitrous Bottle Installation

The nitrous oxide storage cylinder is typically called a “nitrous bottle”. It is an aluminum cylinder, designed and manufactured to withstand very high pressures. The valve on top of the bottle is a high-flow design that allows easy opening and closing which controls the nitrous flow to the engine compartment.

Accurate calibration of your nitrous system depends on the bottle remaining at a stable temperature. In vehicles (such as Corvettes) where the bottle must be mounted in an area subject to direct sunlight, it is suggested that the bottle be shielded with a bottle blanket.

If the bottle is mounted inside the passenger compartment or in a space that has access to the passenger compartment such as hatchbacks or vehicles that feature fold down rear seats, the pressure relief device (PRD valve) must be vented externally from the cockpit. This procedure will prevent the passenger compartment from filling with a cloud of nitrous oxide, should the safety pressure relief valve rupture. For more information, please contact the tech line.

Special consideration should be made to protect the bottle installation by not placing the bottle in a known crumple or crash zone within the vehicle. At no time should the bottle be mounted within the seating area of the passenger compartment of a street-driven vehicle.

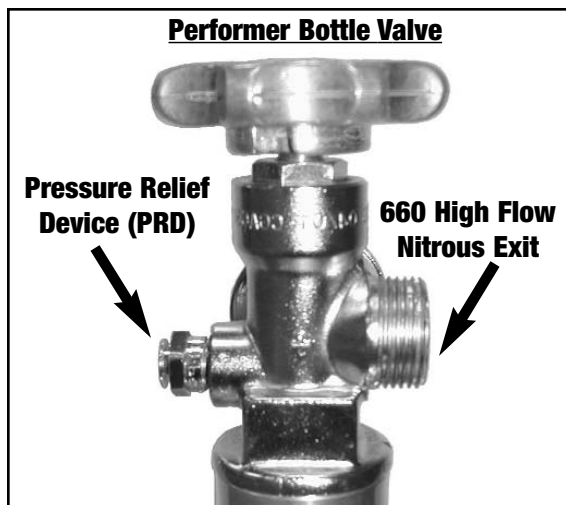

Here is the Performer Bottle Valve. Installed on all bottle valves used in Edelbrock Nitrous Systems, is a Pressure Relief Device or “PRD”. It is a safety valve designed to vent the contents of the bottle into the atmosphere in case of a catastrophic event like a collision. It is also installed to prevent the over-pressurization of the bottle. Unsafe bottle pressure is caused by over filling or elevated bottle temperatures.

There are two types of PRDs - Internal piping and external piping. The internal type requires no additional parts. The external type requires a safety blowdown tube designed to route the gas, if the PRD happens to rupture, to the outside of vehicle. The internal type is design to vent directly off the bottle into the atmosphere.

It is illegal to tamper with or remove this device.

Bottle Safety Information

1. **Do not** attempt to remove the bottle valve. Please return your bottle to Edelbrock if service is required to the siphon tube inside the bottle or the bottle valve itself.
2. **Never** heat the outside of your nitrous bottle with an open flame like that of a torch.
3. **Do not** strike the surface of your nitrous bottle with a heavy or sharp object.
4. **Do not** drop your nitrous bottle.
5. **Do not** attempt to grind off or destroy any imprinted markings on the face of the bottle.
6. **Do not** remove, modify or otherwise tamper with the safety valve on the bottle valve.
7. **Do not** attempt to use a bottle that has been damaged or tampered with.

Racing Vehicles

Before you mount a nitrous bottle in a vehicle intended for use in racing or sanctioned events, check with the sanctioning association or local racetrack for any rules regarding bottle installation. Most associations require the bottle be mounted within the confines of the safety roll cage, with the safety pressure relief cap vented away from the driver’s compartment.

2.2 Bottle Orientation

Accurate calibration of your nitrous system depends on the bottle remaining at a stable temperature. Choosing the proper location and orientation for your bottle can greatly affect the overall operation of the nitrous system. Please read the entire bottle mounting instruction section before making your final bottle location decisions.

Bottle placement is critical to the performance of your nitrous system. It is important to understand how the bottle valve and siphon tube are assembled to properly orient the bottle in your vehicle and ensure that it picks up liquid nitrous while undergoing acceleration. All nitrous bottles are assembled so that the bottom of the siphon tube is at the bottom of the bottle, opposite the bottle label.

An Edelbrock nitrous bottle cannot be mounted upside-down. Edelbrock does not offer a non-siphon tube bottle for automotive use. If the bottle must be mounted parallel to the axles of the vehicle (sideways), the label must be angled at approximately 45 degrees toward the front of the vehicle. This orientation will position the siphon tube toward the rear and pointing to the lower rear-facing quadrant of the bottle. All of this positioning information is critical to system operation. It is most important to draw as much liquid nitrous as possible. The siphon tube cannot do this unless the bottle is positioned correctly.



The most efficient mounting is the lay-down position with the valve handle toward the front of the vehicle. This position allows the greatest amount of liquid to be used before the siphon tube begins to pick up gaseous nitrous oxide.



An alternative method of mounting the nitrous bottle is in the horizontal position. This method is only recommended if you have limited space restraints in the trunk area. In the horizontal position, bottle angle when mounting is much more critical. Follow the horizontal mounting angles as outlines in the figure below.

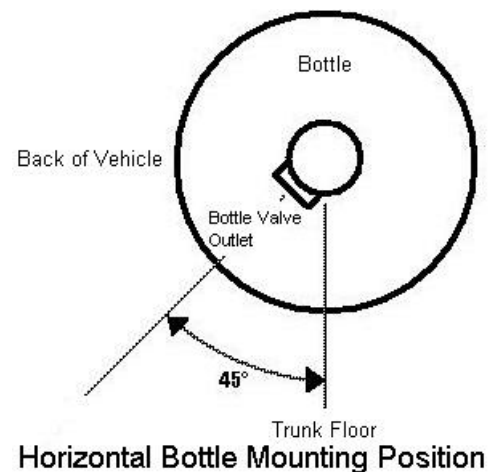

2.3 Nitrous Bottle Installation

After you have determined the location and orientation of the nitrous bottle, use the following procedure to install the bottle:

2.3.1 Street Car Installations

1. Disconnect vehicle's battery.
2. Determine the location of the bottle within the confines of the rear of the vehicle.
3. Once a mounting location has been determined, raise the vehicle (following all safety practices involved in working on a vehicle from under the vehicle) and verify that there are no fuel lines, fuel tank(s), brake lines, emissions equipment, or structural members in the way of potential mounting bolt locations.
Note: *It may be necessary to remove the fuel tank depending on the location where you install the bottle.*
4. Install the rubber insulators within the bottle brackets.
5. Slip bottle into the mounting brackets.
6. Using the mounting bracket bolt holes as templates, mark an area for each of the brackets with chalk, metal marking pen, scribe, or marking pen to locate the bolt placements for drilling.
7. Drill two (2) 3/8" mounting holes for each bracket.
8. If heater blanket is used, brackets must be installed 8-1/2 inches apart from each other.
9. Install the bottle mounting brackets using "Grade 8" bolts, nuts and flat washers (not included with kit). Use fender washer underneath the vehicle for sheet metal mounting.
10. Tighten the mounting bolts using a thread locking compound (not included with kit).
11. Mock up Safety Blowdown tube on bottle to find where tube will go through floor.
12. Mark floor where tube appears it will go.
13. Using a 1/2" drill bit, drill through floor on mark.
14. Install Safety tube on bottle and cut off excess tube so that only 1 to 2 inches are protruding below floor.



Shown here is a bottle with a bottle bracket properly installed with the rubber insulator. The distance between the bottle brackets is somewhat adjustable. Remember, mount the short bottle bracket at least 1" from the bottom of the bottle, and never cover any of the bottle label with a bottle bracket.

Do not attempt to install the bottle in the bracket without the rubber insulator. The bottle hoop on the bracket is designed to include the thickness of the insulator.

2.3.2 Race Car Nitrous Bottle Installations

Install the bottle brackets in accordance to race track and/or sanctioning body rules. Contact the factory for assistance with meeting sanctioning body rules.

2.3.3 Nitrous Bottle Installations For Vehicles With Hatchbacks Or Trunk Areas That Are Connected With The Passenger Compartment.

Please contact Edelbrock for more information.

2.4 Nitrous Feed Line Mounting

1. Determine the route your main nitrous feed line will follow. Ensure the path does not route the nitrous feed line too close to the exhaust system, suspension, electrical lines/components or tires.
2. Attach nitrous supply line to bottle.
3. Feed nitrous line along proposed route.
4. Secure nitrous supply line to underside of vehicle.

Note: Stainless steel covering of the main nitrous feed line is very abrasive. Shield painted components or sensitive system components like electrical, fuel lines, brake lines or suspension components to prevent them from contacting main feed line. Rubber hose can be slid over and retained as a chafe guard.

5. Leave nitrous line loose pending installation of nitrous solenoid.

2.5 Solenoid Mounting

Use the following procedures to install your Performer solenoids.

Note: Remember to use Teflon paste only on pipe threads. **Do not use Teflon tape.**

Hint: Placement of the solenoid is often limited by the lack of possible mounting locations in the engine compartment. However, if possible, observe the following suggestions:

Solenoid Safety Information

1. Keep solenoids and lines away from exhaust components.
2. Trial fit the solenoids with all lines attached to ensure a proper fit.
3. Solenoids may be mounted sideways or upside-down, if necessary.

Preparing to Mount Your Solenoids

1. Locate the universal solenoid mounting brackets and solenoid mounting screws.
2. These solenoid brackets can be modified to clear almost any potential interference in the engine compartment. Please look at the pictures and potential solenoid mounting locations and adapt your brackets according to the needs of your particular application.



Pictured above is an unmodified Performer solenoid bracket with a modified bracket with solenoid attached, ready for installation in the engine compartment.

2.5.1 Nitrous Solenoid Mounting and Installation

1. Hold the nitrous solenoid securely (such as in a bench vise) being careful not to harm the solenoid or block the inlet or outlet of the solenoid.
2. Install nitrous filter fitting (Blue fitting 4AN X 1/8NPT) using liquid Teflon paste in the inlet port of the nitrous solenoid.
3. Install the blue 3AN X 1/8NPT fitting using liquid Teflon in the outlet port of the nitrous solenoid.
 - i. Remove nitrous solenoid assembly from vise.
 - ii. Attach solenoid mounting bracket to the bottom of the nitrous solenoid.
 - iii. Verify the desired mounting location for the nitrous solenoid.
4. Install the nitrous solenoid. If the solenoid mounting location is difficult to access, leave the solenoid loose so the solenoid inlet and outlet ports can be easily accessed.
5. Leave the wires loose for electrical installation.
6. Attach the nitrous feed line to the inlet side of the solenoid.

Pictured here are the Performer Solenoids mounted in the engine compartment. When mounting your solenoids, be sure that the solenoids are located in a place where you have ample line lengths between the nozzle and the solenoids. Be sure that there is a little slack in the lines between the nozzle and solenoids to prevent any lines from kinking. Be sure that the inlet and outlet ports of the nitrous and fuel solenoids are easily accessible. If you are mounting your solenoids in a location where accessibility might be a problem, install the lines onto the solenoids before mounting the solenoids in their mounting location.

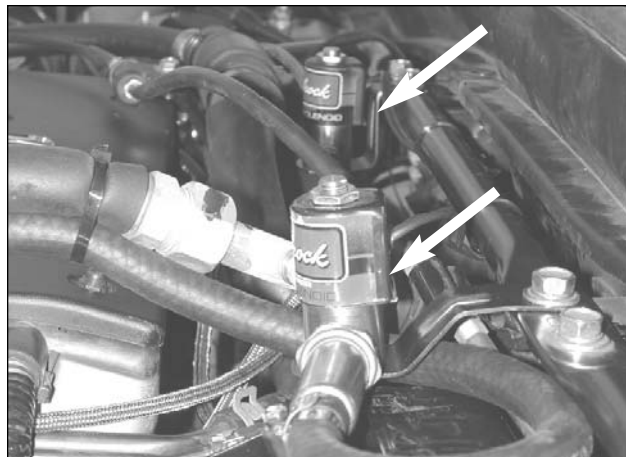

2.5.2 Fuel Solenoid Mounting and Installation

1. Hold the fuel solenoid securely (such as in a bench vise) being careful not to harm the solenoid or block the inlet or outlet of the solenoid.
2. Install the 1/8 NPT to Fuel Hose Filter Fitting into the fuel inlet fitting using liquid Teflon paste in the inlet port of the fuel solenoid.
3. Install the red 3AN X 1/8 NPT flare fitting using liquid Teflon paste in the outlet port of the fuel solenoid.
4. Remove the fuel solenoid assembly from vise.
5. Attach the universal solenoid mounting bracket to the bottom of the fuel solenoid using 2 of the solenoid mounting screws.
6. Verify the desired mounting location of the fuel solenoid.
7. Install the fuel solenoid. If the solenoid mounting location is difficult to access, leave the solenoid loose so the solenoid inlet and outlet port can be easily accessed.
8. Leave the wires loose for the electrical system installation.

2.6 Nozzle Installation

1. Determine the nozzle mounting location in the intake boot, just before the throttle body. Make sure that the nozzle, mounting collar, and the feed lines from solenoids to nozzle, do not interfere with any systems or components of the vehicle such as the hood latching device.
2. Mark where the nozzle will be placed.
3. Remove the intake boot.
4. Drill a 7/16" hole in the intake boot where nozzle placement was determined.
5. Remove all the debris left by the drilling operation.
6. Before installing the nut and collar into the intake boot, check the depth of the nozzle into the collar. If the nozzle does not protrude far enough, use a 1/8"-27 NPT tap to tap the hole to the proper depth. Refer to the diagram on the following page to check for the proper nozzle depth. Install the nozzle mounting nut and collar into the inlet pipe.

2.6 Nozzle Installation (Continued)

- Using liquid Teflon, install the nozzle into the mounting collar.
- Be sure the nozzle discharge is facing towards the throttle body.
- Install the correct jets into the fuel and nitrous inlet fittings of the nozzle. Please refer to the **Section 1.2 Jet Map Information** to determine the correct nitrous and fuel jets to install into the nozzle.
- Install the 3AN lines from the solenoid outlet fittings to their corresponding spray nozzle jet fittings and tighten securely.
- Install the intake boot.

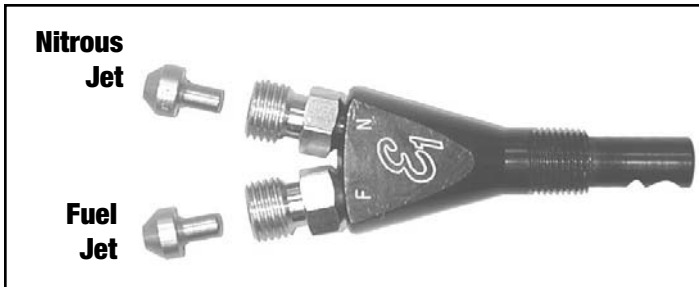

Shown above is the E1 nitrous nozzle that is supplied with your kit showing the correct jets being installed in the fittings. Nitrous and fuel jets are similar in appearance except for their orifice sizes which are stamped on the jet body. When installing the nitrous and fuel jets supplied with your system, be certain that you are installing the correct jet in the correct nozzle inlet. By installing the **incorrect** jets into the nozzle inlets, **severe engine damage will occur**. Please refer to **Section 1.2 Jet Map Information** for the correct jets to install in your nozzle.

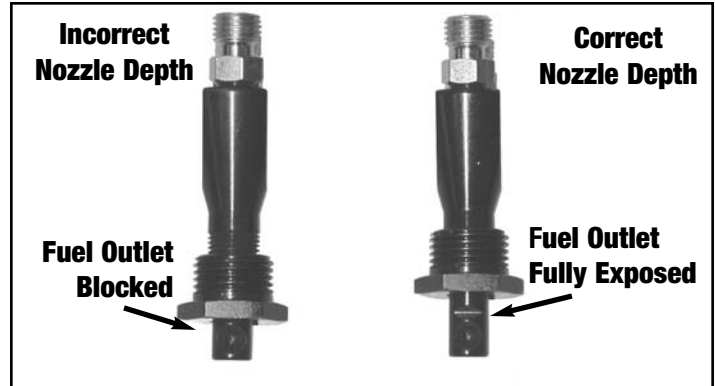

Shown above is the correct and incorrect nozzle depth. Be certain that the nozzle protrudes as shown to prevent severe engine damage. If the nozzle does not protrude far enough, the fuel outlet will be blocked, causing an extreme lean condition in the engine which would cause a catastrophic engine failure. If the depth is incorrect, use a 1/8"-27 NPT tap to achieve the correct depth.

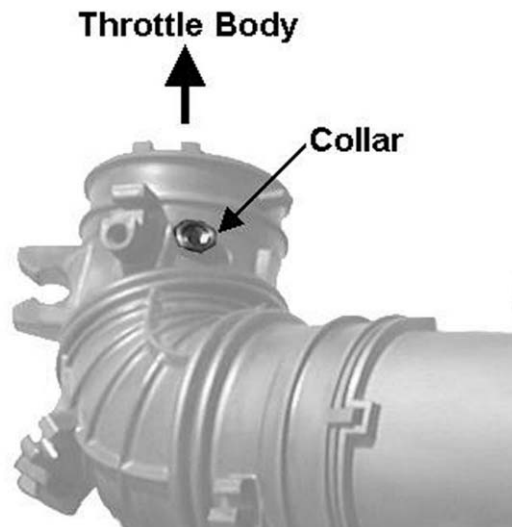

Nozzle should be placed in the intake boot so as to have a clear path to the throttle body. Try to keep the nozzle from having to travel through the bend in the intake boot and as close to the throttle body as possible. Shown above is an installed collar and nut in the stock intake boot of a Honda Civic.

2.7 Fuel Line Installation

Before performing any of these steps, relieve the fuel pressure in the vehicle's fuel system.

1. Remove the engine cover shield and intake boot to gain access to the fuel line.
2. Locate the fuel line which should be by the throttle body, with one end attached to the fuel rail, and the other attached to the main fuel line which comes from the tank.
3. Grasp the fuel line insert with either your fingers or blunt-nosed pliers, and pull the fuel line away from the insert to remove the fuel line as shown below. The insert will remain attached to the fuel rail. Do this with both ends of the fuel line.

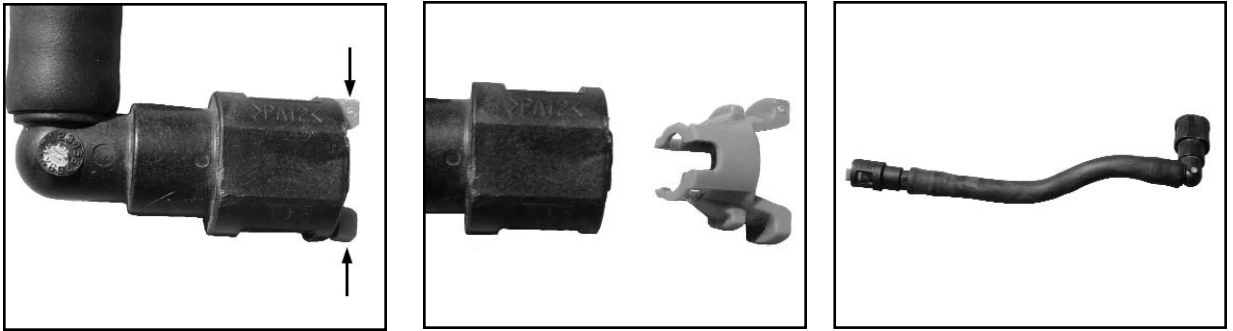

4. Remove the fuel line insert from the hard fuel line.
5. Install a section of the supplied 5/16" Fuel Hose from the outlet of the main fuel line from the tank to the inlet of the fuel rail. Be sure to leave yourself about 2 inches of play in the fuel hose. Secure each end with the supplied hose clamps.
6. Cut the fuel hose that you just installed in the middle of the line to install the supplied 5/16" Hose Barb Tee. Secure the cut ends of the fuel hose using the supplied hose clamps.
7. Install a section of 5/16" Fuel Hose from the outlet of the 5/16" Hose Barb Tee to the fuel solenoid inlet fitting. Secure each end of the fuel hose with the supplied hose clamps.

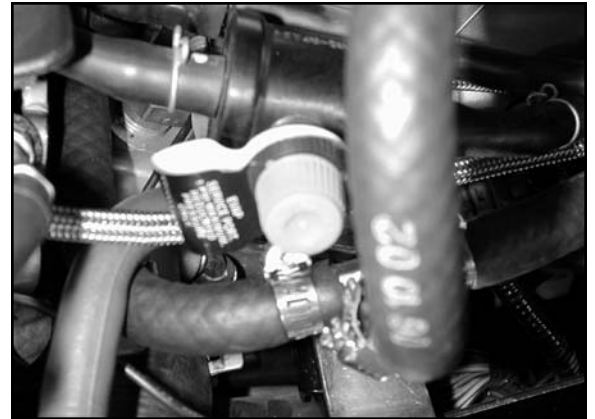
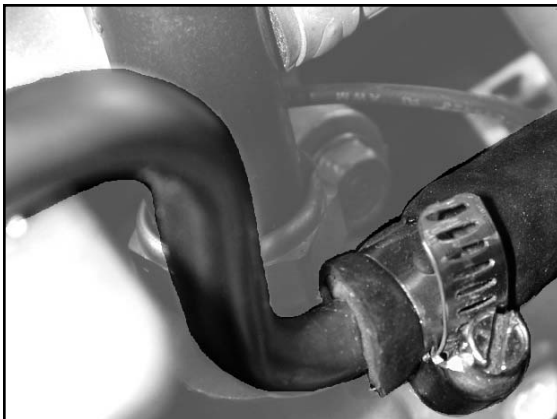

3.0 Electrical System Installation



3.1 Nitrous Electrical Components Bill of Materials (BOM)

Item #	Quantity	Description
1	1 ea.	Activation microswitch
2	1 ea.	Activation microswitch bracket (not shown)
3	2 ea.	Activation microswitch mounting nut
4	2 ea.	Activation microswitch mounting screw
5	1 ea.	30 amp relay
6	1 ea.	Wire harness with integral relay/fuse holder
7	1 ea.	Red lighted toggle switch
8	2 ea.	18/22g female spade connector, Nylon insulated
9	2 ea.	14/16g female spade connector, Nylon insulated
10	1 ea.	14-16g male spade connector, Nylon insulated
11	1 ea.	16/18, splice connector
12	1 ea.	14/16g 3/8" ring terminal, Nylon insulated
13	3 ea.	18/22g ring terminal #10 Stud, Nylon insulated
14	2 ea.	18/22g ring terminal #8 Stud, Nylon insulated (.187)
15	2 ea.	18/22g female spade connector, Nylon insulated
16	1 ea.	15 amp ATO blade fuse

Nomenclature Descriptions:

ATO... the fuse configuration is ATO. When replacing this fuse, ask for an ATO fuse.

"a"... Amperage.

Important: The wiring hardware and instructions included with this kit are intended for 12-volt electrical systems only. Before attempting to wire your Edelbrock Performer nitrous oxide system, examine and follow the wiring diagram on the following page. Please call the Edelbrock Technical department with any questions concerning electrical wiring.



When working with electrical systems in your vehicle, it is a good idea to have a service manual that features your vehicle. It is also good practice to have a book that specializes on the specialized techniques required when working with vehicular electrical systems.

3.3 Nitrous Electrical System Installation Procedures

Determine the location of the relay and fuse holder wire harness. Most common installations locate these components inside the driver's compartment and close to the fuse panel under the dash. You can also mount the relay and fuse holder harness close to the battery. However, these connectors are water-resistant not waterproof, so care is required when mounting this assembly under the hood of your vehicle.

Wire Schematic Origin and Destination Map

Wire Color	System	Origin	Destination	Terminal Used
Red	Bat Voltage	Relay Harness	Bat. Volt. Signal	Ring
Red	Arming Switch	Underdash	Switched 12v	Spade/Wire Intercept
Black	Relay Ground	Relay Harness	Chassis Ground	Ring
Black	Solenoid Ground	Solenoids	Chassis Ground	Ring
Black	Arming Switch Grnd.	Arming Switch	Chassis Ground	Ring
Blue	Solenoid Power	Relay Harness	Solenoids	Spade
White	Microswitch	Relay Harness	Microswitch	Spade
White	Microswitch	Arming Switch	Microswitch	Spade

3.4 Nitrous Relay and Fuse Holder Installation

The wire harness attached to the relay and fuse holder includes 8 feet of color-coded wires to make the electrical system installation for your Edelbrock Nitrous System as easy as possible. We recommend that you do not cut any lengths of wires from the wire harness or complete the wiring of the nitrous system until all of the mechanical components are securely mounted in their permanent locations.

Once all of the solenoids and switches are placed, then route the un-cut wires from the harness to each location allowing enough wire length on each circuit to not interfere with operating linkages, heat sources, brackets, etc. Pay particular attention to sharp edges along the route of your wire harness as they can chafe the wire and cause your system to fail.

After you have accounted for the routing of your wires, follow the Wire Harness Schematic in Section 3.2 and use the Origin and Destination Map as a guide for which electrical connectors are used in each circuit.

Once you have decided the location of the relay and fuse holder, secure them with fasteners (not included with kit) such as sheet metal screws, bolts and nuts, etc. Allow for some slack in the red wire that connects the relay and fuse holders together.

When mounting your relay and fuse holder, make sure the mounting surface is strong enough to support servicing the relay and fuse. Also, ensure you allow for some slack in the wire that joins the fuse holder to the relay mount. This will avoid any potential loss of power due to stress on the wire harness.

The fuse is covered by the fuse mount housing.

The relay for the Performer system is rated for 30 amps, and the fuse is 15 amps.

3.5 Arming Switch and Installation

The arming switch is a red, lighted switch that is a “MASTER” arming switch for your nitrous system. Without it, your nitrous system would be “on” all of the time and capable of engaging anytime you go to wide-open throttle conditions with your vehicle. The switch, when in the “armed” position, is well lit. Therefore, it should be placed in an obvious position well within the line of sight and easy reach of the driver. Please refer to the procedures below for the installation of the arming switch:

1. Locate the final position of your arming switch.
2. Drill a .450” (approx. 29/64”) hole for the switch location.
3. Insert the switch from behind the mounting hole and secure with the switch nut.
4. Do not wire until all other mechanical components are in place. Please see the electrical system installation instructions for further information.

Note: There is a collar included with the switch for applications that require special spacing during installation.

3.6 Microswitch Installation and Wiring

The function of your microswitch is to enable your nitrous system. It should be installed so that the switch is forced closed by coming in contact with the throttle linkage only at the wide open throttle position. The nitrous system must only function at fully-loaded wide-open throttle.

MICROSWITCH SAFETY INFORMATION

1. **Do not** allow wiring from the microswitch to come in contact with heat sources on the intake manifold such as EGR risers or passageways.
2. **Do not** run wires to the microswitch that can create interference with the operation of the throttle linkage.
3. The microswitch must be located in such a way as to be clear of the normal operation of the throttle linkage.
4. **Do not** directly expose the microswitch to liquids such as water or gasoline.



This is a picture of an un-modified and “ready to install” microswitch assembly. The microswitch bracket has several mounting positions available for clocking of the switch. It also is of a universal length and can be attached to several positions on and around the throttle body.

3.6 Microswitch Installation and Wiring (continuation)...

The bolts used to attach the microswitch have extra length to allow for spacing the microswitch away from the bracket to offer a level of adjustability of the microswitch. After determining the position of the microswitch, we recommend trimming the bolts for a clean installation.

Due to the wide variety of throttle linkage combinations in use, it is impossible to supply a microswitch bracket custom tailored to each application. The universal bracket supplied will need to be modified to fit your specific application.

Here is a microswitch assembly mounted for use. It is an example of one of many ways in which to mount a microswitch on your throttle body. The microswitch bracket allows for many different mounting positions. The microswitch bracket can be modified to clear almost any potential interference around the throttle linkage.

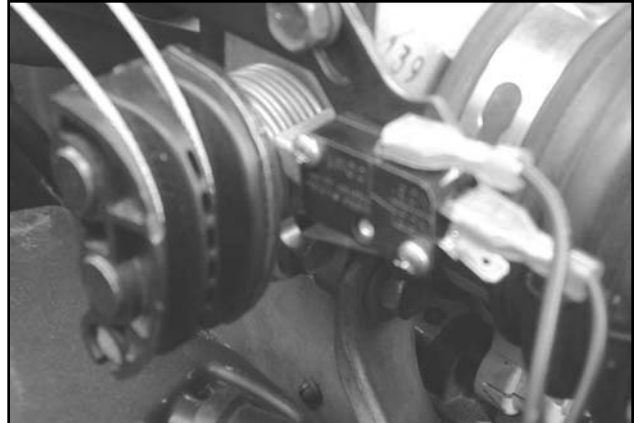

The microswitch bracket supplied is drilled to permit many different switch mounting positions. This flexibility allows for the microswitch to be positioned in such a manner to engage the throttle body linkage without interfering with its normal and safe operation. The bracket may be manipulated (bent, twisted, and/or cut) to best suit your combination. Mount the microswitch on the throttle body so the actuation arm is triggered by the throttle linkage making sure that all wiring and the bracket do not interfere with the smooth and safe operation of the throttle body. Be sure the actuation arm “clicks” at the point where the throttle is wide open.

3.7 Final Electrical Installation Recommendations

At this time, it is advised that you double-check the following areas:

1. **Double Check** all wires so that they do not come in contact with any heat sources like exhaust manifolds, and EGR crossovers, etc.
2. **Double Check** the wires that lead from the microswitch to ensure that they do not interfere with the operation of the throttle body linkage.

You are now ready to hook up your battery and prepare your vehicle to run.

4.0 Before You Run Your Vehicle Using Your Edelbrock Nitrous System

You have just completed the installation of your Edelbrock Nitrous System. It is time to perform some basic system checks to ensure all of the work you have done is correct and ready to operate properly. The following procedure is designed to validate the operation of your nitrous system before operating your vehicle:

Note: Before performing steps 1 through 4, make sure that the nitrous bottle is closed and main nitrous supply line is empty of any nitrous.

4.1 Fuel System Check

1. Hook up all battery leads.
2. Double-check all wires and leads for signs of heat and proper connections.
3. Turn the ignition to the "on" position but do not start the engine.
4. Check all fittings for leaks.
5. Switch master arming switch to the "on" position (switch should now glow red). **Make sure the nitrous bottle is closed and the main feed line are completely empty of ANY nitrous!** Standing by the engine compartment, tap the microswitch and listen to hear the solenoids click open. If both solenoids are clicking, the solenoids have been installed correctly. Wait a minimum of 30 minutes before starting the vehicle so as to be sure that any fuel that was sprayed into the intake has time to evaporate.

4.2 Nitrous System Check

1. With the vehicle's engine running, slowly open nitrous bottle valve.

Note: *There should be no change in engine idle speed. If idle speed changes, close nitrous bottle valve immediately and refer to the "Troubleshooting Guide" section.*

2. Inspect nitrous lines and fittings for leaks using a soapy water mixture and a small brush.
3. If any of the fittings/connections show bubbling around the attachment nut or on the threaded area of the fitting, shut the nitrous bottle valve off immediately and dry the fitting before attempting any service to that particular fitting connection.
4. If the engine idle does not come up, and all of the fittings appear to be leak-free, you have successfully completed the installation of your Edelbrock Nitrous System.

5.0 Solenoid Inspection and Maintenance

1. Close valve on nitrous bottle.
2. Make sure all nitrous supply lines are free of pressure before removal of any system solenoid.
 - a. Empty main nitrous supply line at the nitrous bottle. Take care to not breathe or expose your skin to nitrous.
 - b. **Do not open pressurized fuel lines over a hot engine.**
3. Remove nitrous solenoid from the engine and securely clamp it into a vise, taking great care not to damage the solenoid.
4. Remove the solenoid cover, retaining nut from top of the nitrous solenoid.
5. Remove coil and housing from nitrous solenoid base.
6. Unscrew stem from nitrous solenoid base. Do this by using a solenoid stem removal tool or by “double nutting” the stem and unscrewing the stem from the housing body. **Do not use pliers on solenoid stem;** damage to the stem will result.
7. Carefully remove the stem, spring and plunger from the solenoid base paying close attention to the way they are assembled.
8. Examine the plunger seal for swelling, cuts and abrasions. The seal surface should be flat, except for a small circular indentation in the center of the seal.

A seal that has been contaminated or over-pressurized will bulge from exposure to chemicals other than nitrous oxide. It can appear to extend down from the plunger and be dome-shaped. A contaminated seal may return to its original shape if left out in fresh air for approximately 48 hours. It may then be returned to service. If it does not return to its original shape, it must be replaced.
9. Clean the solenoid body. **Do not use an oil-based solvent to clean any part of the solenoid.** Use paint thinner or electrical contact cleaner. Remove any contaminants that may be present. Make sure solenoid body is clean, dry and free of oils before assembly.
10. Replace the O-Ring, plunger and piston spring.
11. Re-assemble solenoid by reversing disassembly procedure.

6.0 Troubleshooting and Routine Maintenance

How to use our Troubleshooting Flowchart:

The troubleshooting of a nitrous system is basic and straightforward. The symptom chart is divided by symptom, cause and action required. Determine your problem (symptom), identify the potential problem (cause) and correct the problem (action required).

Symptom #1... Change in engine speed when nitrous bottle valve is opened.

1. Malfunctioning nitrous solenoid.
 - a. Refer to the section entitled *6.0 Solenoid Inspection and Maintenance*.
 - b. Repair/replace solenoid.
2. Contamination in nitrous solenoid.
 - a. Refer to the section entitled *6.0 Solenoid Inspection and Maintenance*.
 - b. Clean/replace solenoid.

Symptom #2... Engine runs excessively rich when system is activated.

1. Nitrous bottle valve not fully opened.
 - a. Check bottle valve.
 - b. Open valve fully.
2. Nitrous bottle mounted improperly.
 - a. Mount bottle properly. See section entitled *2.1 Nitrous Bottle Mounting*.
3. Plugged nitrous filter.
 - a. Clean and/or replace nitrous filter.
 - b. See nitrous solenoid symptom #1.
4. Low bottle pressure.
 - a. Weigh bottle.
 - b. Bottle should be 10 lbs. above empty bottle weight listed on bottle label.
 - c. Check bottle temperature.
 - d. Maintain 80 to 85 degrees of bottle surface temperature.

Symptom #3... No change in performance when system is activated.

1. System wired incorrectly.
 - a. Compare wiring to schematic. See section entitled *3.3 Electrical System Wiring Diagram*.
 - b. Wire per instructions.
2. Loose ground wires.
 - a. Connect test light to battery "+" (positive) terminal. Check for continuity at grounds.
 - b. Tighten/repair loose grounds.
3. No power to arming switch.
 - a. With ignition "on", connect test light to battery "-" (negative) terminal. Check for power at pole #1 on arming switch.
 - b. Repair wiring as necessary.
4. Malfunctioning arming switch.
 - a. With ignition "on", turn arming switch "on." Connect test light to battery "-" (negative) terminal. Check for power at terminal #1 wire on arming switch.
 - b. If power is present, replace arming switch.
5. Malfunctioning microswitch.
 - a. Turn arming toggle "off". Open (lever is not being activated) throttle microswitch, check for continuity between microswitch wiring terminals.
 - b. If continuity is present, replace microswitch.

6. Inadequate nitrous supply.
 - a. Weigh bottle.
 1. Bottle should be 10 lbs. above empty bottle weight listed on bottle label when full.
 - b. Check bottle pressure.
 1. Maintain 900-950 psi for optimum system performance.
 - c. Check bottle temperature.
 1. Maintain 80 to 85 degrees of bottle surface temperature.
 - d. Check bottle valve.
 1. Open valve fully.
 - e. Check bottle orientation. See section entitled *2.3 Nitrous Bottle Orientation*.
 1. Mount bottle properly.
7. Loose nitrous solenoid wiring.
 - a. Inspect solenoid wiring. See section entitled *3.4 Nitrous Electrical Installation Procedures*.
 - b. Repair wiring as necessary.
8. Malfunctioning nitrous solenoid.
 - a. Inspect solenoid wiring. See section entitled *3.4 Nitrous Electrical Installation Procedures*.
 1. Repair wiring as necessary.
 - b. Inspect solenoid. See symptom # 2.
 1. Rebuild/replace solenoid.

Symptom #4... Engine detonates mildly when system is activated.

1. Inadequate octane fuel.
 - a. Verify what gasoline you use.
 1. Use higher-octane fuel.
2. Spark plug heat range too high.
 - a. Verify what heat range the spark plug is, and how it functions in a high load, high performance application.
 1. Install a performance spark plug.
 2. Reduce spark plug heat range.
3. Too much nitrous flow.
 - a. Verify the size of the nitrous jet.
 1. Install the proper nitrous jet.
 - b. Check bottle temperature and pressure.
 1. Ensure before every nitrous usage that you only use nitrous when the temperature and pressure of your bottle are correct.

Symptom #5... Vehicle surges under acceleration when system is activated.

1. Inadequate nitrous supply.
 - a. Weigh bottle.
 1. Bottle should be 10 lbs. above empty bottle weight listed on bottle label when full.
 - b. Check bottle temperature.
 1. Maintain 80 to 85 degrees of bottle surface temperature.
 - c. Check bottle valve.
 1. Open valve fully
 - d. Check bottle orientation. See section entitled *2.3 Nitrous Bottle Orientation*.
2. Check bottle mounting. Be sure bottle is mounted correctly. See section entitled *2.1 Nitrous Bottle Mounting*.