

INSTALLATION SHEET

TUFF TONNO III™

& Saber TONNO

extang



NEW Improved
"DOUBLE HOOK"
Side Rail Clamps

Spring Bows
(x3-Short Bed)
(x4-Long Bed)

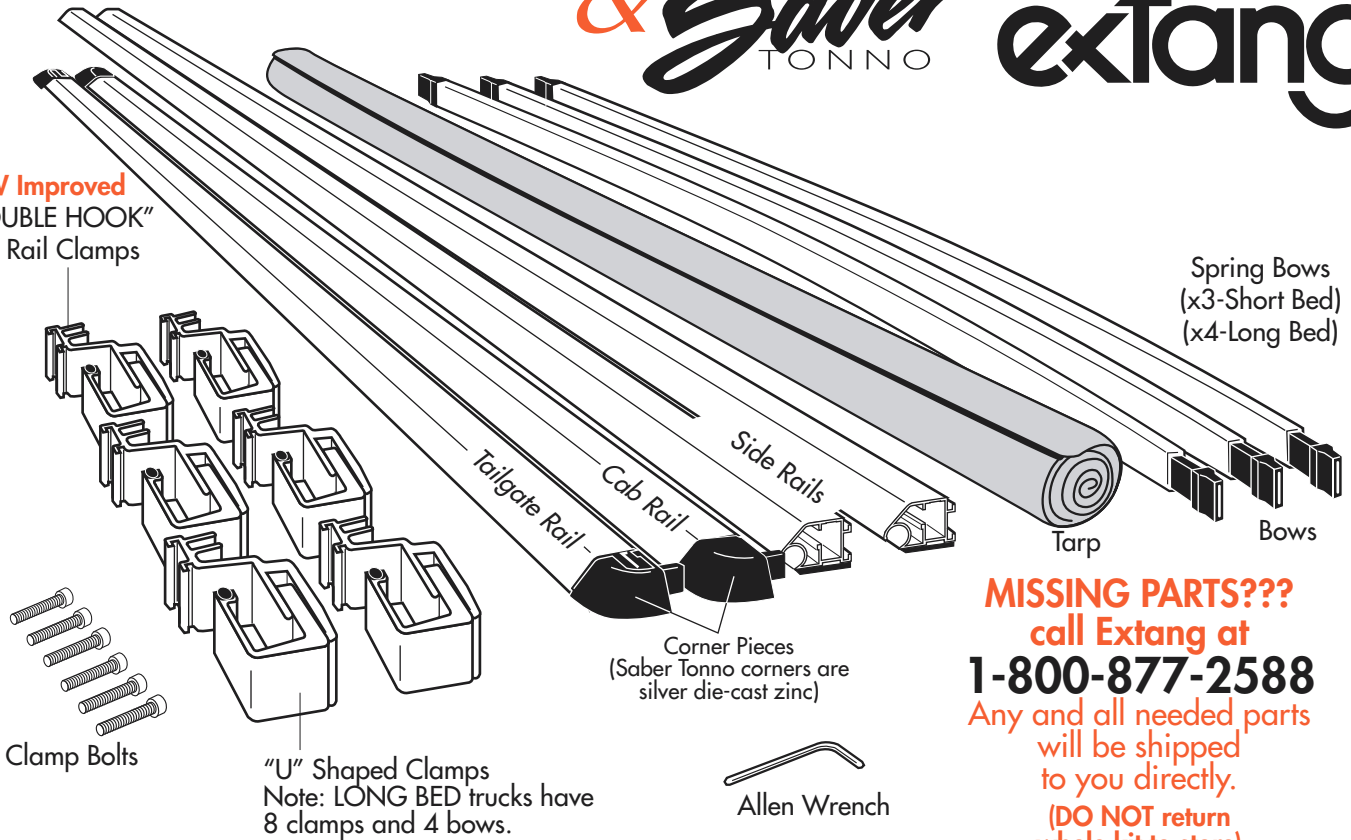

MISSING PARTS???
call Extang at
1-800-877-2588
Any and all needed parts
will be shipped
to you directly.
**(DO NOT return
whole kit to store)**

PARTS INCLUDED IN YOUR KIT. You may want to lay them out in this manner for accessibility.

1

Wash truck bed.

2

Foam has **NO adhesive**
to touch truck finish.

Remove paper tape from all rails.
Discard properly.

3

Depress the mechanism,
release, and remove one
corner from cab rail.

LeverLock™
(Tuff Tonno III)

ClickLock™
(Saber Tonno)

4

Off the truck bed, connect
the end rails to the two
side rails.

Feed tarp dowel into
cab rail. **NOTE:** For
easiest feeding action,
place tarp on a flat
smooth surface, and keep
dowel straight while
feeding into cab rail.

**Caution,
pavement may
scuff tarp.**

Reinsert corner piece into
cab rail until it "clicks" and
locks into place.

extang
Stands for Quality

Extang Corporation
1901 E. Ellsworth Rd.
Ann Arbor, MI 48108
734 677-0444, Fax: 734 677-8409

Visit us at:
www.extang.com

Item No. 0018-1202 RH Printed in U.S.A.

For an OVER-THE-RAIL Bedliner

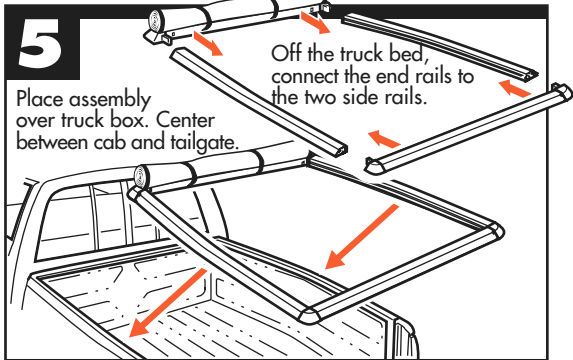

5
Place assembly over truck box. Center between cab and tailgate.

Off the truck bed, connect the end rails to the two side rails.

DIAGRAM
A

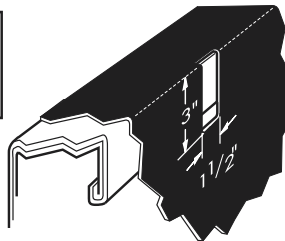
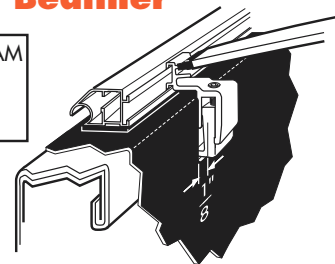
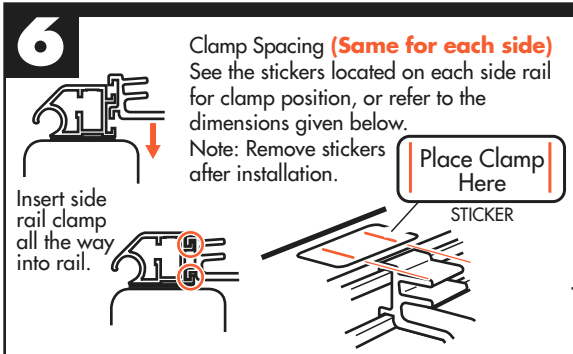

DIAGRAM
B



For each clamp mark on your bedliner a 1-1/2" x 3" hole as shown above. Remove clamp. Cut holes in bedliner. Reinsert side rail clamp. Return to step 5.

Side rail clamped to bed with bow attached.



6
Clamp Spacing (Same for each side)
See the stickers located on each side rail for clamp position, or refer to the dimensions given below.
Note: Remove stickers after installation.

Insert side rail clamp all the way into rail.

Place Clamp Here
STICKER

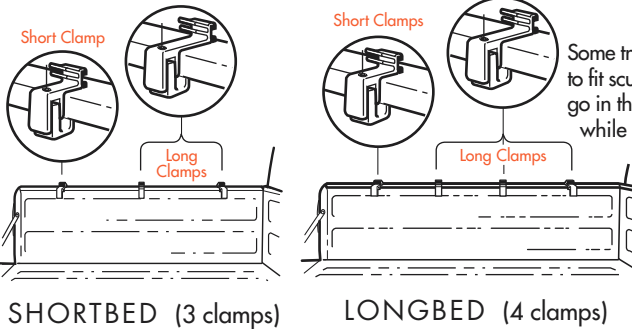

SHORTBED (3 clamps)

LONGBED (4 clamps)

Longer Clamps

Some trucks use two lengths of bracket to fit sculpted sidewalls. Longer clamps go in the forwardmost (Cab) positions while the shorter pair hold the rails at the rear (tailgate) end.

FOR INSTALLATION IN THE FOLLOWING TRUCK MODELS:

Ford HD Long-Bed
Ford HD Short-Bed

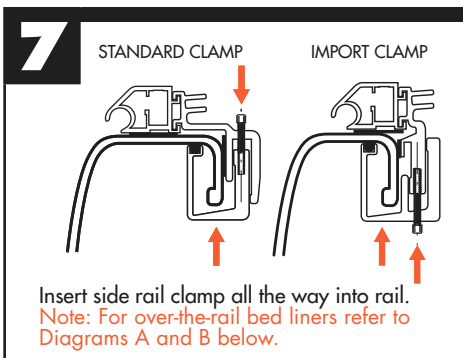

STANDARD CLAMP

IMPORT CLAMP

Insert side rail clamp all the way into rail.
Note: For over-the-rail bed liners refer to Diagrams A and B below.

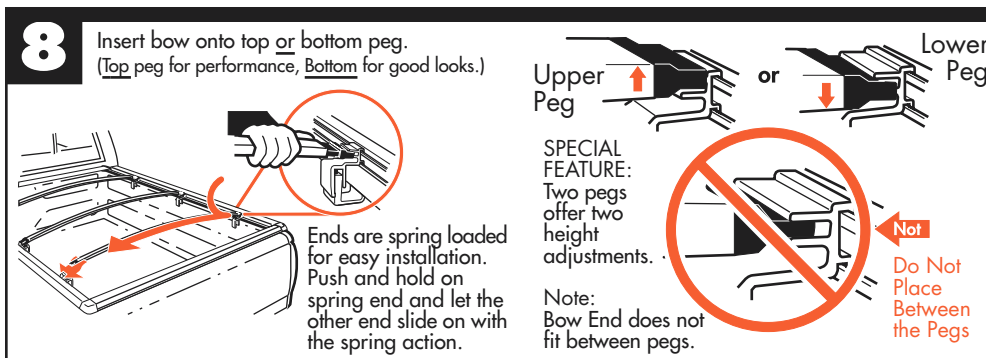

8 Insert bow onto top or bottom peg.
(Top peg for performance, Bottom for good looks.)

Upper Peg

Lower Peg

SPECIAL FEATURE:
Two pegs offer two height adjustments.

Note:
Bow End does not fit between pegs.

Do Not Place Between the Pegs

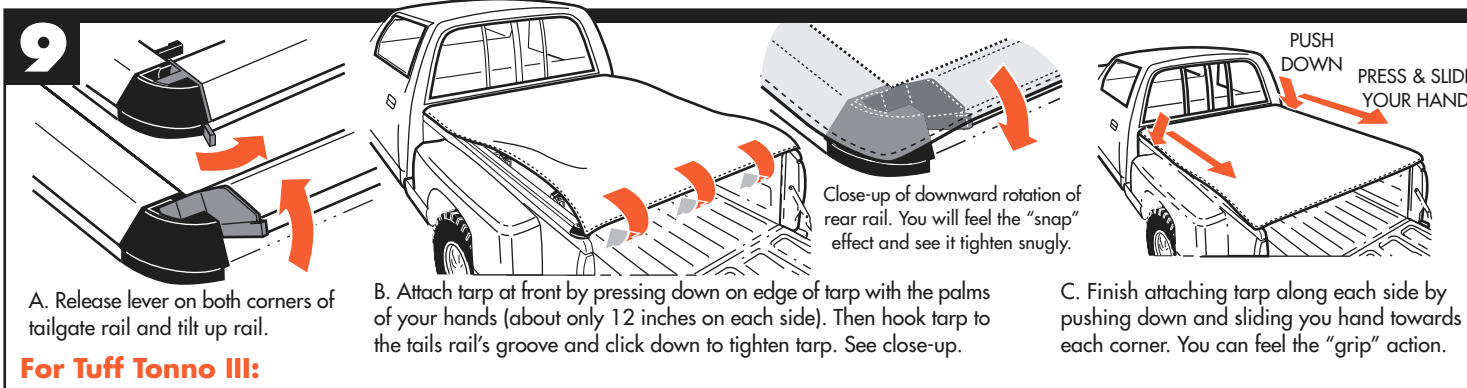

A. Release lever on both corners of tailgate rail and tilt up rail.

B. Attach tarp at front by pressing down on edge of tarp with the palms of your hands (about only 12 inches on each side). Then hook tarp to the tails rail's groove and click down to tighten tarp. See close-up.

C. Finish attaching tarp along each side by pushing down and sliding your hand towards each corner. You can feel the "grip" action.

For Tuff Tonno III:

For Saber Tonno:

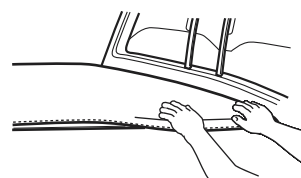

A. Attach tarp from front corner (12 inches). Repeat for each side.
Note: Pull tarp out while pressing down in center of the side strip to flex hook open for easy attachment.

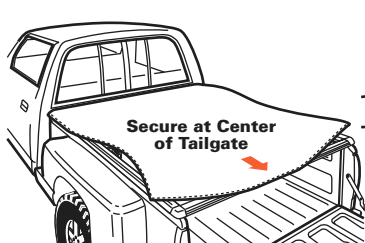

B. Secure tarp at the middle of tailgate rail.

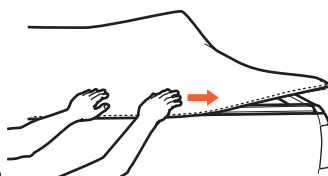

C. Finish attaching tarp along each side by pushing down and sliding your hand front to rear, and on tailgate rail, by pressing out from the center.

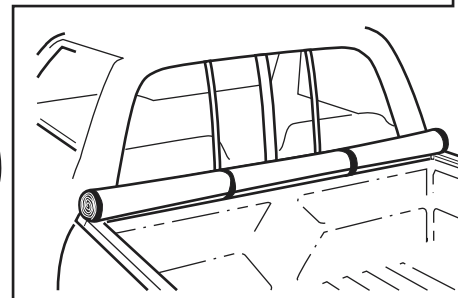

EASY USE OF TRUCK BED

Tarp may be rolled up and secured with Velcro® for bulk hauling