

# INSTALLATION SHEET

## TUFF TONNO III™

## & Saber TONNO

## extang



**NEW Improved**  
"DOUBLE HOOK"  
Side Rail Clamps

Spring Bows  
(x3-Short Bed)  
(x4-Long Bed)

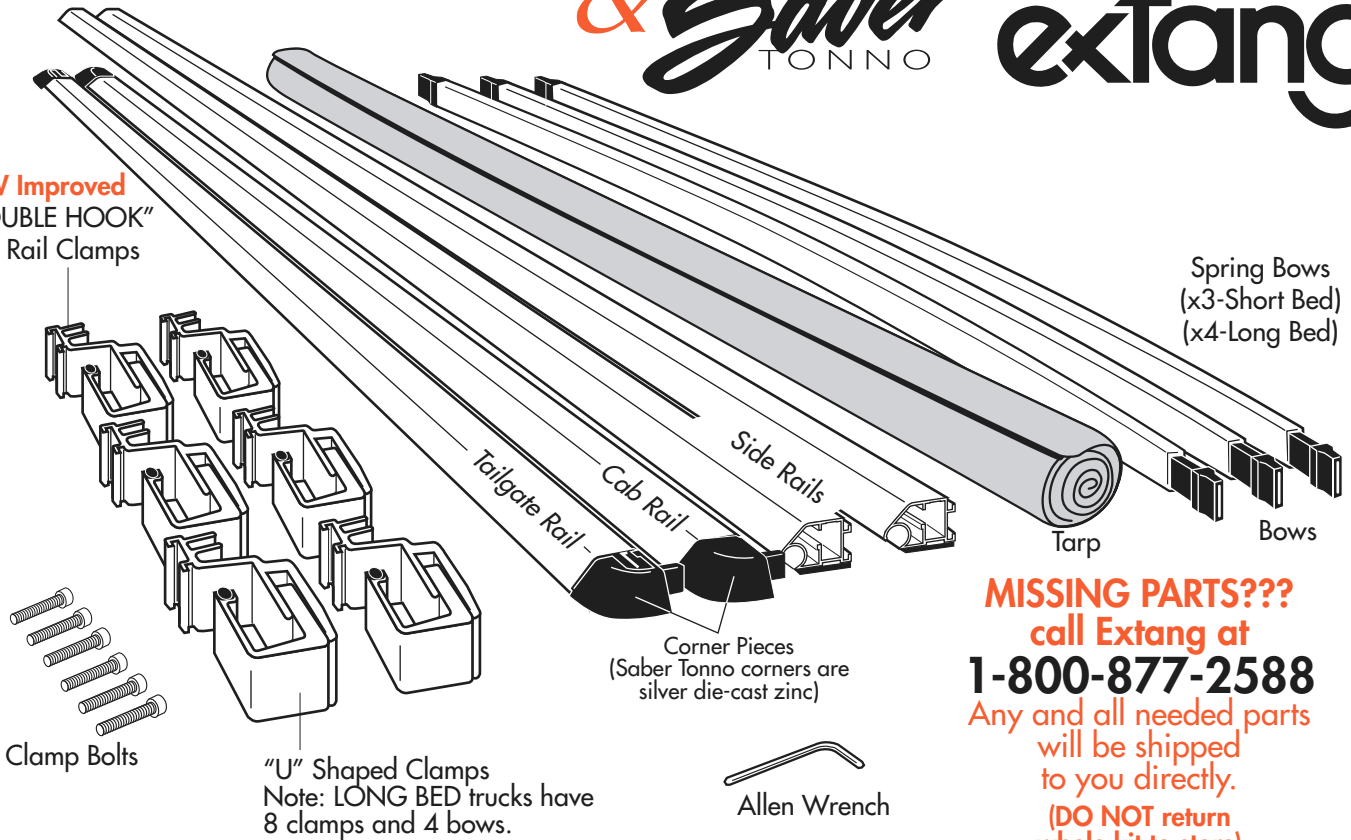

**MISSING PARTS???**  
call Extang at  
**1-800-877-2588**  
Any and all needed parts  
will be shipped  
to you directly.  
**(DO NOT return  
whole kit to store)**

Clamp Bolts

"U" Shaped Clamps  
Note: LONG BED trucks have  
8 clamps and 4 bows.

Allen Wrench

PARTS INCLUDED IN YOUR KIT. You may want to lay them out in this manner for accessibility.

**1**

Wash truck bed.

**2**

Foam has **NO adhesive**  
to touch truck finish.

Remove paper tape from all rails.  
Discard properly.

PLEASE  
DO NOT  
LITTER

**3**

Depress the mechanism,  
release, and remove one  
corner from cab rail.

LeverLock™  
(Tuff Tonno III)

ClickLock™  
(Saber Tonno)

**4**

Off the truck bed, connect  
the end rails to the two  
side rails.

Feed tarp dowel into  
cab rail. NOTE: For  
easiest feeding action,  
place tarp on a flat  
smooth surface, and keep  
dowel straight while  
feeding into cab rail.

**Caution,  
pavement may  
scuff tarp.**

Reinsert corner piece into  
cab rail until it "clicks" and  
locks into place.

**extang**  
Stands for Quality

Extang Corporation  
1901 E. Ellsworth Rd.  
Ann Arbor, MI 48108  
734 677-0444, Fax: 734 677-8409

Visit us at:  
**www.extang.com**  
Item No. 0018-1202 RH Printed in U.S.A.

## For an OVER-THE-RAIL Bedliner

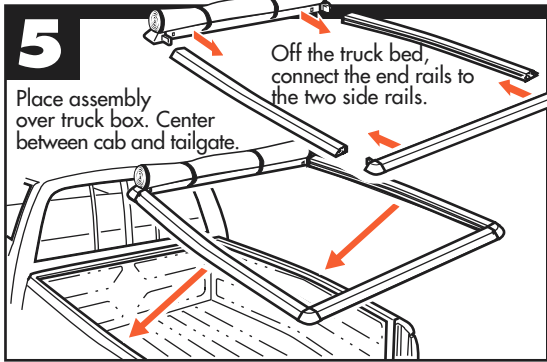

DIAGRAM  
**A**

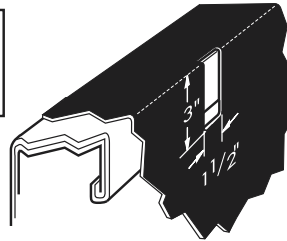
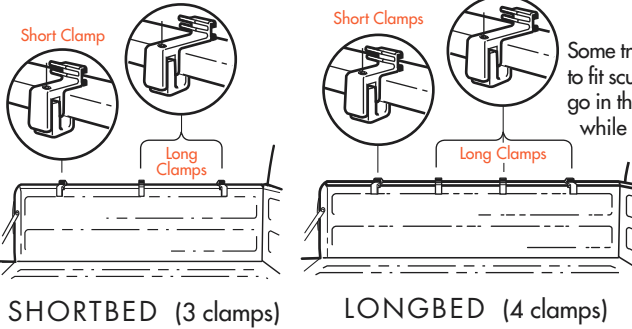
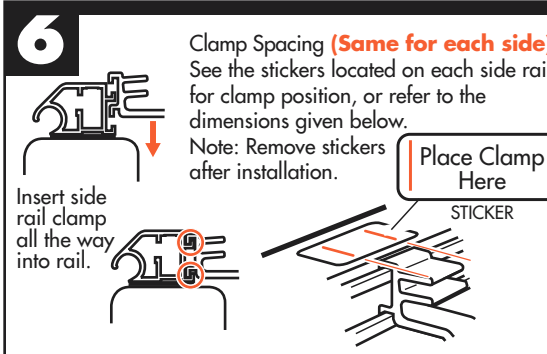

DIAGRAM  
**B**



For each clamp mark on your bedliner a 1-1/2" x 3" hole as shown above. Remove clamp. Cut holes in bedliner. Reinsert side rail clamp. Return to step 5.

Side rail clamped to bed with bow attached.



### Longer Clamps

Some trucks use two lengths of bracket to fit sculpted sidewalls. Longer clamps go in the forwardmost (Cab) positions while the shorter pair hold the rails at the rear (tailgate) end.

### FOR INSTALLATION IN THE FOLLOWING TRUCK MODELS:

Ford HD Long-Bed  
Ford HD Short-Bed

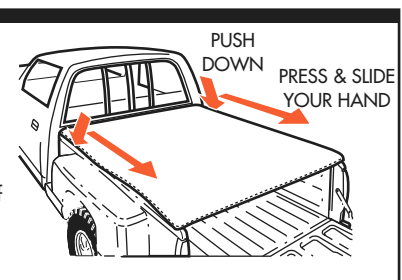
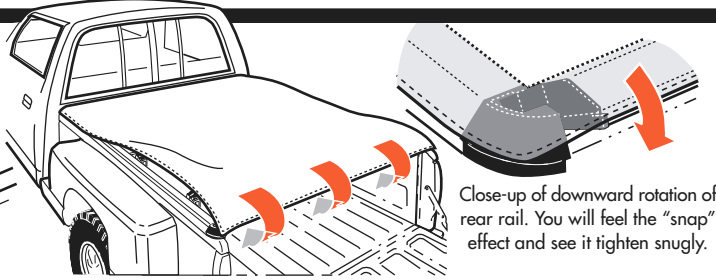
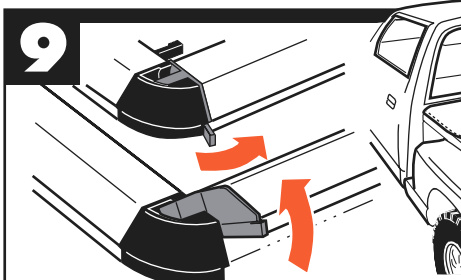
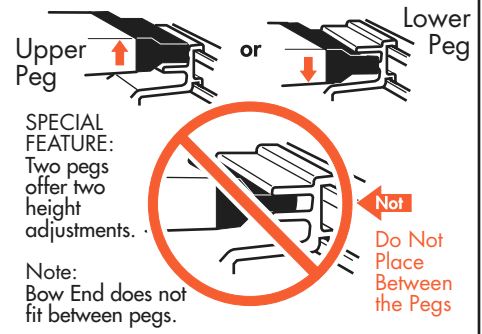
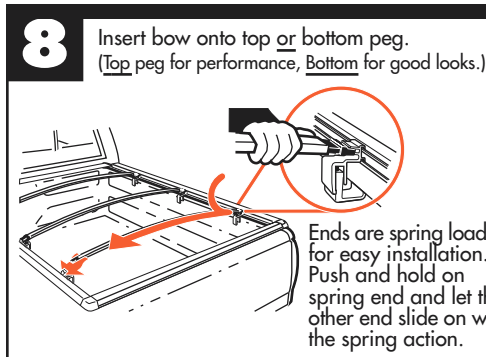
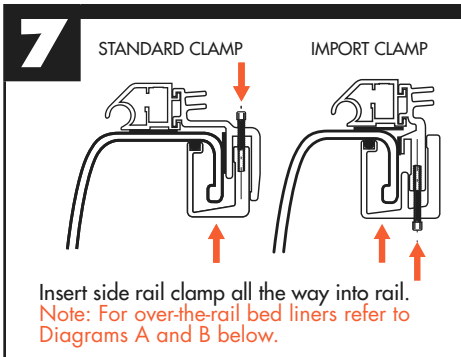

A. Release lever on both corners of tailgate rail and tilt up rail.

B. Attach tarp at front by pressing down on edge of tarp with the palms of your hands (about only 12 inches on each side). Then hook tarp to the tails rail's groove and click down to tighten tarp. See close-up.

C. Finish attaching tarp along each side by pushing down and sliding your hand towards each corner. You can feel the "grip" action.

### For Tuff Tonno III:

### For Saber Tonno:

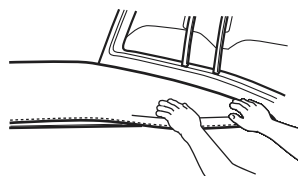

A. Attach tarp from front corner (12 inches) Repeat for each side.  
**Note: Pull tarp out while pressing down in center of the side strip to flex hook open for easy attachment.**

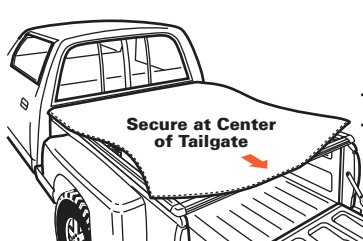

B. Secure tarp at the middle of tailgate rail.

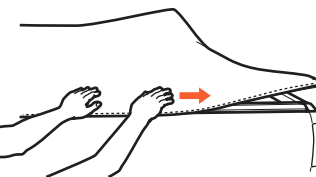

C. Finish attaching tarp along each side by pushing down and sliding your hand front to rear, and on tailgate rail, by pressing out from the center.

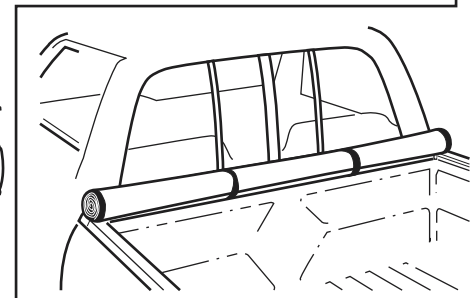

### EASY USE OF TRUCK BED

Tarp may be rolled up and secured with Velcro® for bulk hauling