

INSTALLATION SHEET

CLASSIC
PLATINUM & BLACKMAX™

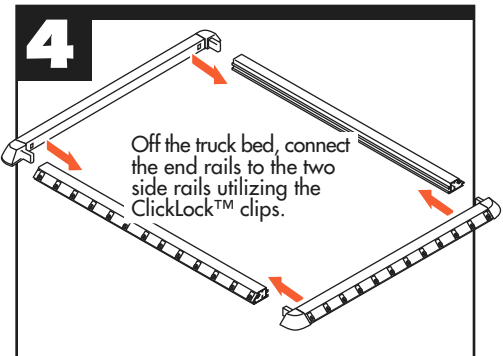

PARTS INCLUDED IN YOUR KIT. You may want to lay them out in this manner for accessibility.

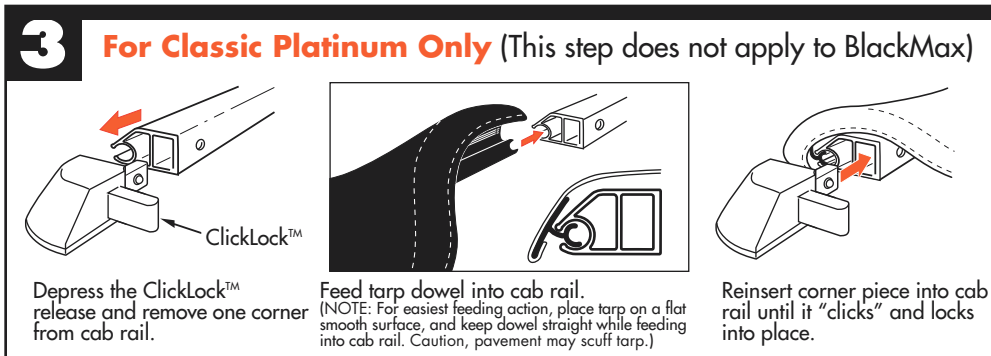
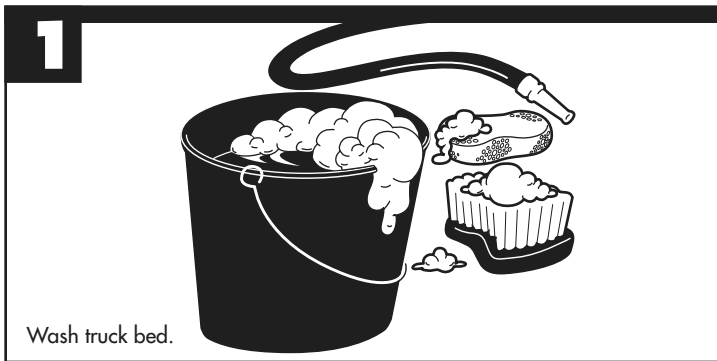

extang
Stands for Quality

Extang Corporation
1901 E. Ellsworth Rd.
Ann Arbor, MI 48108
734 677-0444, Fax: 734 677-8409

Visit us at:
www.extang.com

Item No. 0016-1202 RH Printed in U.S.A.

For an OVER-THE-RAIL Bedliner

5



Place the rail assembly over the side of the truck box. Center rails evenly between cab and tailgate. (NOTE: Some applications have hard rubber risers (square rubber pad.) A riser must go toward tailgate. Some applications will have a riser at both ends, (most have no riser).

DIAGRAM

A



For each clamp mark on your bedliner a 1-1/2" x 3" hole as shown above. Remove clamp. Cut holes in bedliner. Reinsert side rail clamp. Return to step 6.

DIAGRAM

B

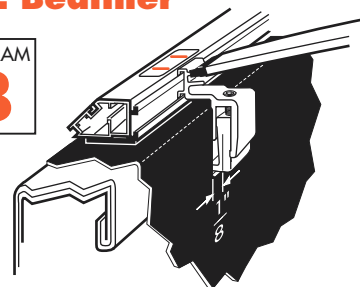

Side rail clamped to bed with bow attached.

6

Note: For over-the-rail bed liners first refer to Diagrams A and B above.

Clamp Spacing (Same for each side)

See the stickers located on each side rail for clamp position, or refer to the dimensions given below. Note: Remove stickers after installation.

Place Clamp Here
STICKER

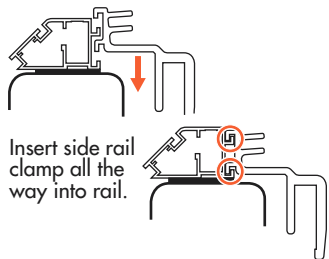

Insert side rail clamp all the way into rail.

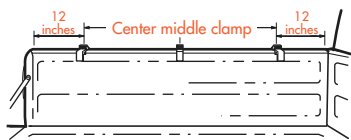

SHORTBED (3 clamps)



LONGBED (4 clamps)

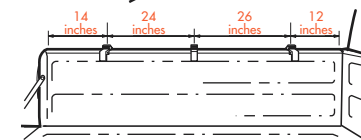

FORD FLARESIDE (3 clamps)

7

STANDARD CLAMP

IMPORT CLAMP

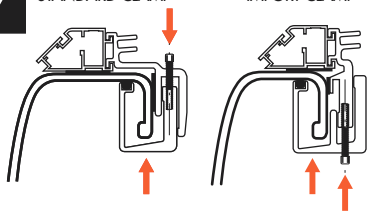

Attach "U" clamp to side rail clamp with allen bolt. Insert side rail clamp all the way into rail.

8

Insert bow onto top or bottom peg. (Top peg for performance, Bottom for good looks.)

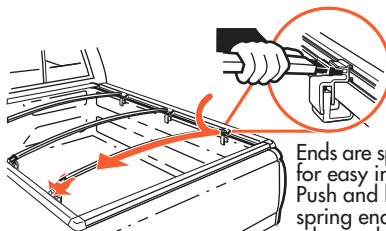

Ends are spring loaded for easy installation. Push and hold on spring end and let the other end slide on with the spring action.

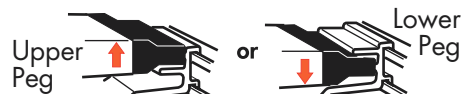

SPECIAL FEATURE: Two pegs offer two height adjustments.

Note: Bow End does not fit between pegs.



Do Not Place Between the Pegs

9

Start at Corners

Attach tarp by starting at the corners, and snap in place.

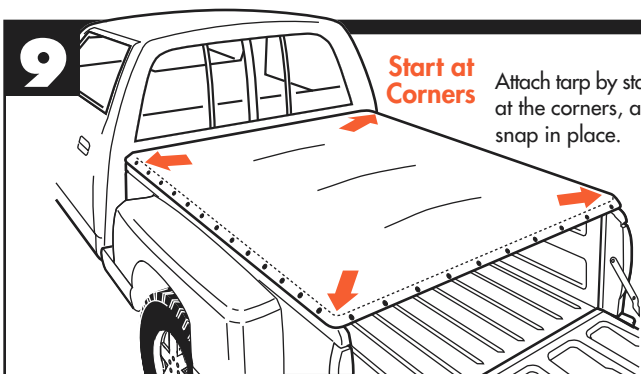

SPECIAL FEATURE Weather-adjustable Snaps

Studs Down

Slides Off

Rotate 180°

Studs Up

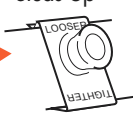
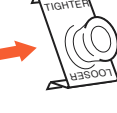
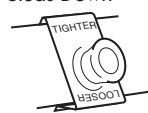

SUMMER SETTING
Takes up slack in tarp caused by warm weather.

WINTER SETTING
Allows more slack in tarp for cold temperatures.

Longer Clamps

for special installations
Some trucks use two lengths of bracket to fit sculpted sidewalls. Longer clamps go in the forwardmost (Cab) positions while the shorter pair hold the rails at the rear (tailgate) end.

FOR INSTALLATION IN THE FOLLOWING TRUCK MODELS:
Ford HD Long-Bed
Ford HD Short-Bed

Short Clamp

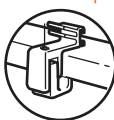

Long Clamps

Short Clamps

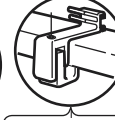
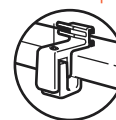

Long Clamps

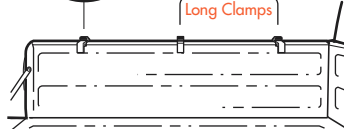

SHORTBED (3 clamps)



LONGBED (4 clamps)

EASY USE OF TRUCK BED

Tarp may be rolled up and secured with Velcro® for bulk hauling