

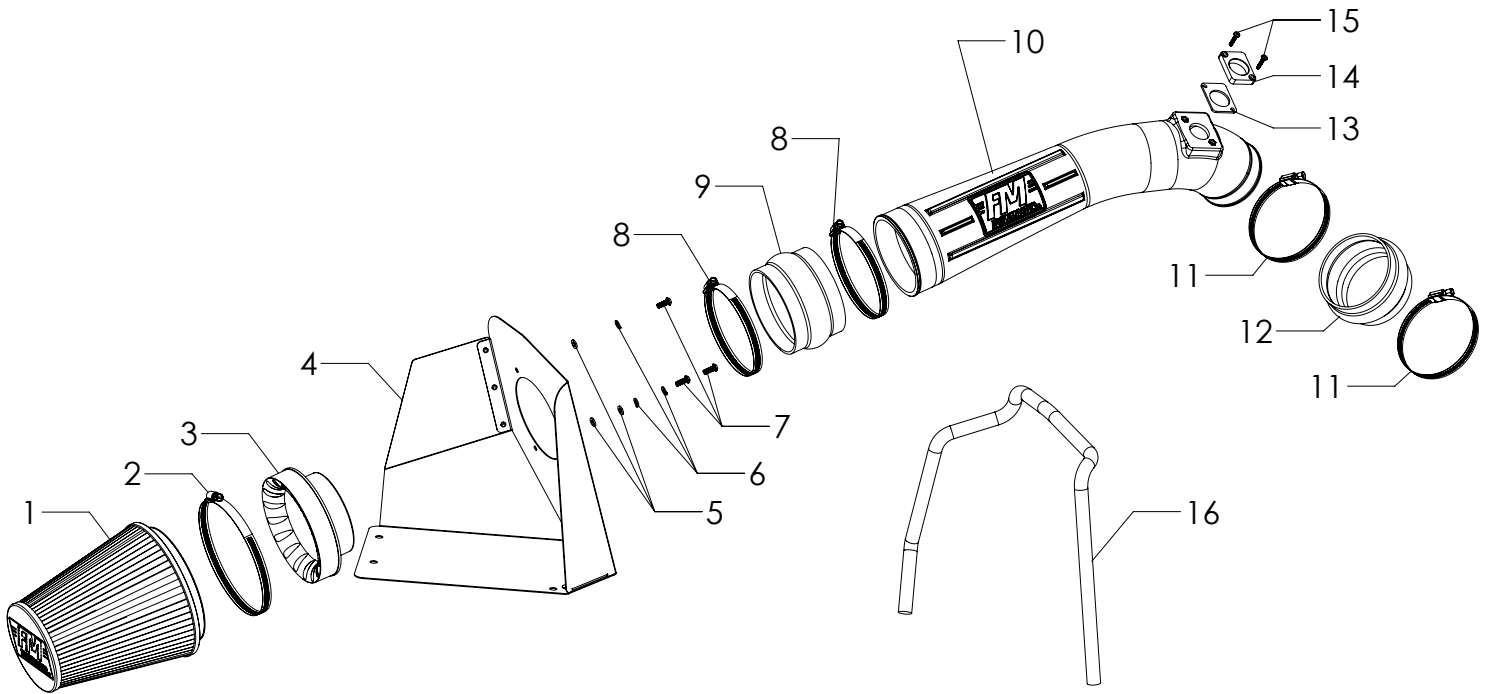

Installation Instructions for: SYSTEM # 615153

2001-2004 Chevy & GMC 2500HD & 3500 trucks with 6.6L Diesel Engines

NOT LEGAL FOR SALE OR USE ON ANY POLLUTION-CONTROLLED MOTOR VEHICLE IN CALIFORNIA OR IN STATES THAT HAVE ADOPTED CALIFORNIA EMISSION PROCEDURES.



REV. 10/13/17

ITEM NO.	PART NUMBER	DESCRIPTION	QTY.
1	AF1001	AIR FILTER, 8-5/8" x 6" DIA	1
2		SCREW CLAMP, #104 (4-1/8" - 7")	1
3	AF6003	ADAPTER, AIR FILTER 4-1/2" x 6"	1
4	AF3033	HEAT SHIELD, 01-04, GM 2500HD & 3500 TRUCKS, 6.6L DSL	1
5	HW319	FLAT WASHER, M6	3
6	HW318	LOCK WASHER, M6	3
7	HW244	SCREW, M6 x 1.0 x 16MM	3
8	MC450H	SCREW CLAMP, #72 (3" - 5")	2

ITEM NO.	PART NUMBER	DESCRIPTION	QTY.
9	AF4021	COUPLER, FLEX 4-1/2" I.D. x 3" L	1
10	AF2033	INTAKE TUBE, 01-04, GM 2500HD & 3500 TRUCKS, 6.6L DSL	1
11	MC400H	SCREW CLAMP, #64 (3-9/16" - 4-1/2")	2
12	AF4019	COUPLER, FLEX 3-1/2" I.D. x 2-1/2" L	1
13	GA141	GASKET, MAF SENSOR, 01-04, GM 2500HD & 3500 TRUCKS, 6.6L DSL	1
14	AF7003	ADAPTER, MAF SENSOR, 01-04, GM 2500HD & 3500 TRUCKS, 6.6L DSL	1
15	HW255	SCREW, M4 x 0.7 x 20MM	2
16	49000061	GASKET, HEAT SHIELD	48"

REVIEW THE INSTRUCTIONS AND VERIFY THE KIT CONTENTS:

1. Please take a moment to read and understand these instructions before installing your Flowmaster cold air intake kit.



2. Use the parts drawing and list (front page) to verify your kit's contents.

In the unlikely event that any parts are missing, please contact Flowmaster Technical Support for replacements.

REMOVE THE FACTORY AIR INTAKE SYSTEM:

NOTES

- We highly recommend that you retain all factory air intake system parts.
- Please refer to vehicle manufacturer's recommendations regarding removal of factory components.
- Disconnecting the negative battery cable erases pre-programmed electronic memories. Write down all memory settings before disconnecting the negative battery cable. Some radios will require an anti-theft code to be entered after the battery is reconnected. The anti-theft code is typically supplied with your owner's manual. In the event your vehicle's anti-theft code cannot be recovered, contact an authorized dealership to obtain your vehicle's anti-theft code.

3. Turn off the vehicle's ignition and disconnect the negative battery cable.



4. Remove the bolt, loosen the screw clamp, and remove the resonator.



5. Loosen the screw clamps securing the intake duct to the airbox and throttle body.



6. Separate the intake duct from the airbox and throttle body, and remove the duct from the vehicle.

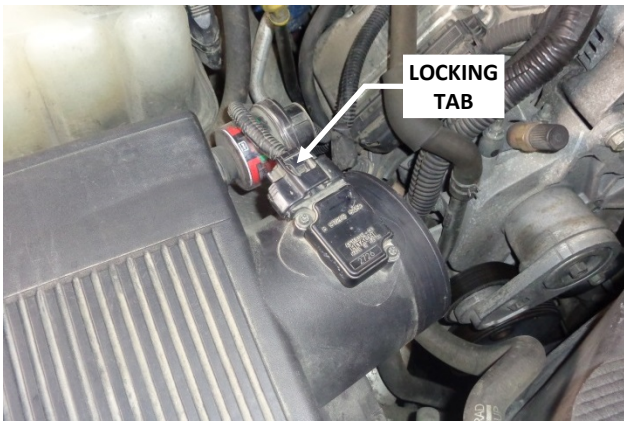

7. Disconnect the electrical plug from the Mass Airflow (MAF) sensor by squeezing the locking tab and pulling the plug straight off the sensor.



8. Remove the airbox by lifting up its inboard side (to release the mount pins from their rubber grommets), then sliding the airbox inboard (to release it from the shelf).

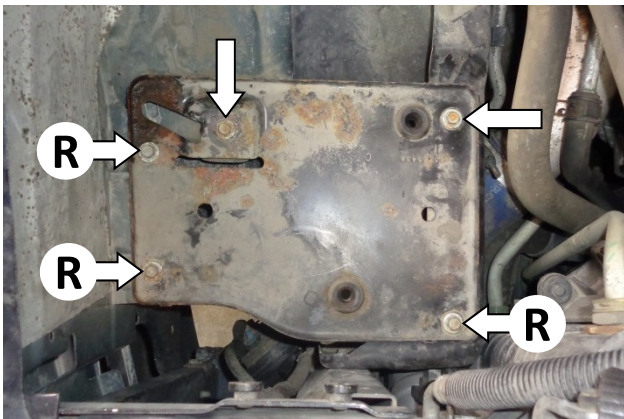

9. Remove the airbox shelf by removing the five bolts. Retain the three bolts marked (R) above.
NOTE: To maintain proper bolt clearances at installation (Step 14), note the length of the bolts removed from locations (R).

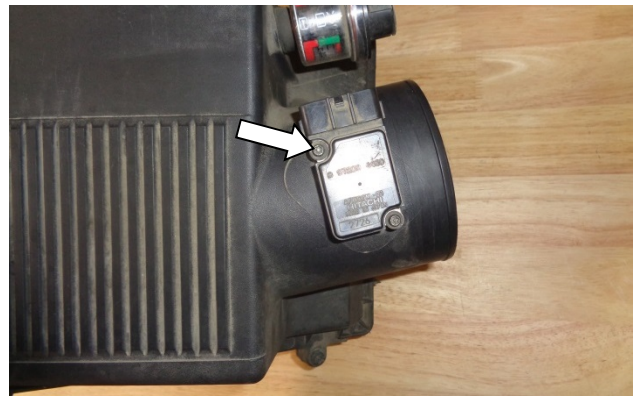

10. Remove the mass airflow (MAF) sensor from the airbox. (Do not remove the o-ring from the sensor.)
CAUTION: The sensor is delicate! Handle it with care, and store it in a safe location until reinstallation.

ASSEMBLE AND INSTALL YOUR FLOWMASTER COLD AIR INTAKE SYSTEM:

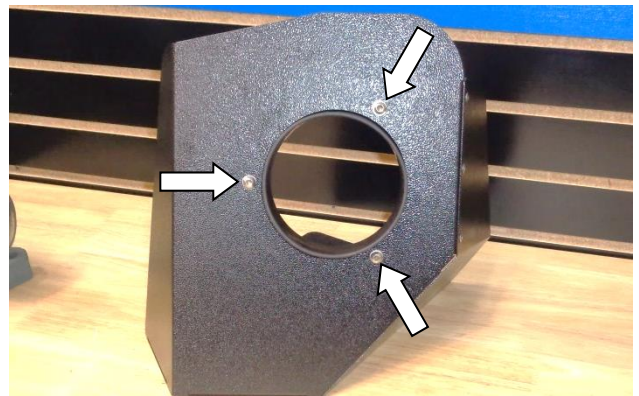

11. Assemble the air filter adapter (3) to the heat shield (4) using the M6 screws (7), lock washers (6) and flat washers (5).

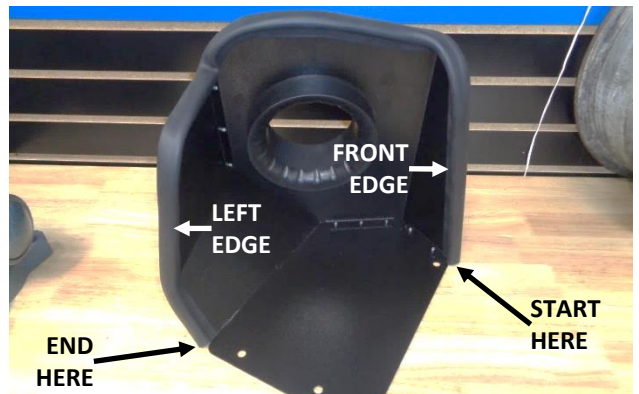

12. Attach the gasket (16) to the heat shield. Starting at the bottom of the front edge, firmly press the seal onto the edge, gradually working your way around. At the bottom of the left edge, use metal-cutting shears to trim the seal to fit.



13. Slip the large screw clamps (8) onto the large coupler (9). Install the coupler on the air filter adapter, push it flush against the heat shield, and tighten the filter adapter clamp.



16. Install the MAF sensor adapter (14) on the sensor with the raised corners facing the sensor as shown. (Lightly lubricate the sensor o-ring if required.)

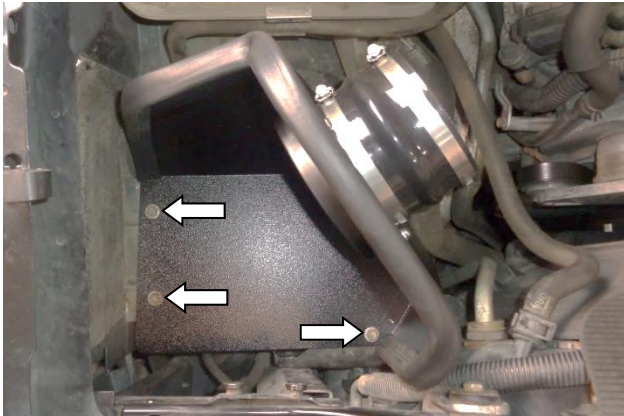

14. Use the three bolts retained from Step 9 to install the assembled heat shield in the vehicle.
NOTE: Be sure to use the correct length bolt at each location, as determined at Step 9.



17. Install the MAF sensor gasket (13) on the assembled sensor and adaptor, ensuring correct orientation. Then install sensor in intake tube (10), using M4 screws (15).



15. Slip the small screw clamps (11) on the small coupler (12), then install the coupler on the turbocharger inlet. Do not tighten the clamps yet.



18. Install the intake tube in the vehicle.



19. Push the small coupler back against the lip on the turbo inlet, and tighten only the turbo inlet clamp.



22. Slip screw clamp (2) onto air filter (1), install the filter on the filter adapter, and tighten the clamp.



20. Center the intake tube between the couplers (so that there is roughly an equal amount of the tube ends inside each coupler), and tighten the two intake tube clamps.



Congratulations, the installation of your FLOWMASTER cold air intake kit is now complete!

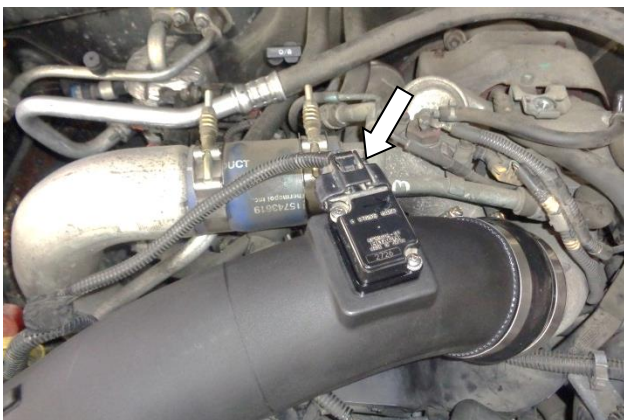

21. Push the MAF sensor plug onto the sensor until it clicks, then verify the connection is secure.