



M-9603-V605 85 mm Cold Air Kit w/Premium Cal. for V6 Mustang INSTALLATION INSTRUCTIONS

NO PART OF THIS DOCUMENT MAY BE REPRODUCED WITHOUT PRIOR AGREEMENT AND WRITTEN PERMISSION OF FORD RACING PERFORMANCE PARTS.

Please contact the Tech Line for the most current instruction information (800) 367-3788.

!!! PLEASE READ THE FOLLOWING INSTRUCTIONS CAREFULLY PRIOR TO INSTALLATION !!!

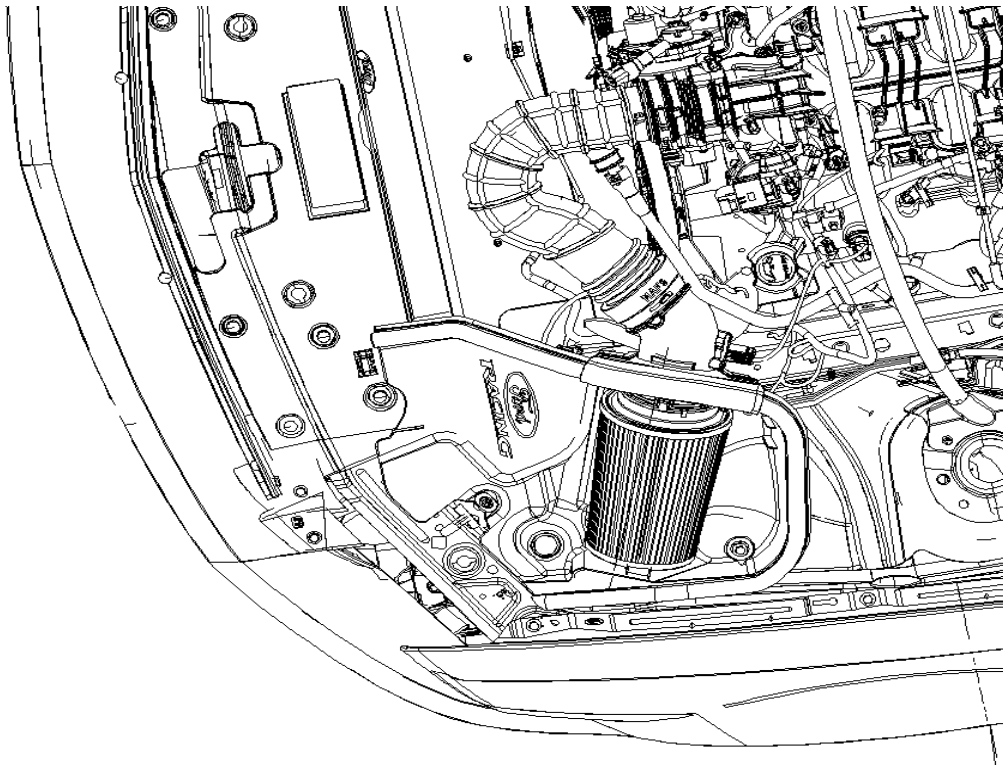

OVERVIEW:

This kit is designed for use on 2005-08 V6 Ford Mustang.

NOTES:

- **BEFORE INSTALLING** the Cold Air Kit, please register this product by following the steps listed on the yellow voucher card included with the kit. **PRODUCT REGISTRATION IS REQUIRED** to receive the ProCal flash tool used to recalibrate the vehicle PCM. Operating the engine without the PCM recalibration will result in engine damage or failure and will **VOID THE WARRANTY.**
- Please read the installation instructions carefully and verify that all items are present. If you are missing hardware or have any questions, please contact the Ford Racing Tech Line at (800) 367-3788.
- Premium fuel (91 octane or higher) is required to prevent "spark knock" or detonation under certain operating conditions. The use of fuel additives (i.e., octane boosters) is not recommended. There is a possibility that these chemicals can damage your engine and cause drivability issues with your vehicle.

Tech Line (800) 367-3788

Factory Ford shop manuals are available from Helm Publications, 1-800-782-4356

IS-1850-0148



M-9603-V605
85 mm Cold Air Kit w/Premium Cal. for V6 Mustang
INSTALLATION INSTRUCTIONS

NO PART OF THIS DOCUMENT MAY BE REPRODUCED WITHOUT PRIOR AGREEMENT AND WRITTEN PERMISSION OF FORD RACING PERFORMANCE PARTS.

KIT INCLUDES:

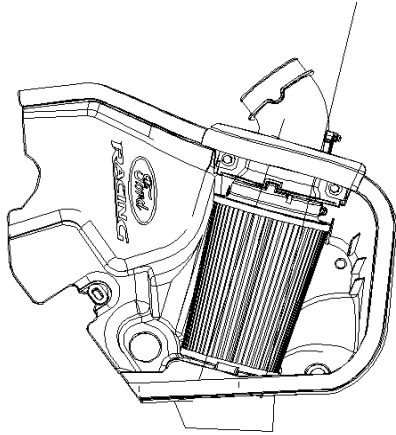

1

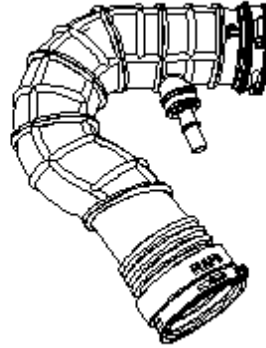

2

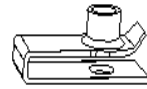

3

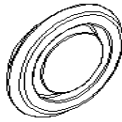

4

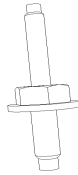

5



6



7

<u>Item #</u>	<u>Qty</u>	<u>Part Number</u>	<u>Description</u>
1	1		Air Intake Bucket Assembly
2	1		Clean Air Tube Assembly
3	1	W710868-S439	U-Nut Upper
4	1	N802981-S	Plug
5	1	W713891-S439	Mounting Stud Upper
6	1	N620480-S437	Nut Upper
7	1		E.O. Label (D-598-2)
8	2	W709287S300	Bolt

Tech Line (800) 367-3788

Factory Ford shop manuals are available from Helm Publications, 1-800-782-4356



M-9603-V605 85 mm Cold Air Kit w/Premium Cal. for V6 Mustang INSTALLATION INSTRUCTIONS

NO PART OF THIS DOCUMENT MAY BE REPRODUCED WITHOUT PRIOR AGREEMENT AND WRITTEN PERMISSION OF FORD RACING PERFORMANCE PARTS.



9

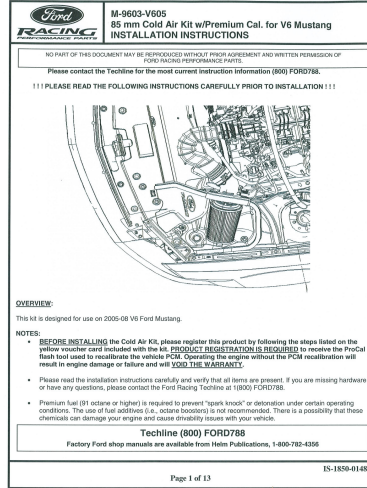

10



11

Item #	Qty	Part Number	Description
9	1	R07140004	Registration/Warranty Voucher
10	1	IS-1850-0148	Installation Instructions
11	0**	NPN	ProCal Flash Tool

The ProCal Flash Tool is **NOT included in the kit. Once you **register** the product and **request** the ProCal tool, one will be shipped to you.

EQUIPMENT AND SUPPLIES REQUIRED:

- Metric ratchet / extension / socket set
- Torque wrench
- T-20 Torx Bit screwdriver or socket

Tech Line (800) 367-3788

Factory Ford shop manuals are available from Helm Publications, 1-800-782-4356



M-9603-V605 85 mm Cold Air Kit w/Premium Cal. for V6 Mustang INSTALLATION INSTRUCTIONS

NO PART OF THIS DOCUMENT MAY BE REPRODUCED WITHOUT PRIOR AGREEMENT AND WRITTEN PERMISSION OF FORD RACING PERFORMANCE PARTS.

SAFETY PRECAUTIONS:

!!! STOP! CAREFULLY READ THE IMPORTANT SAFETY PRECAUTIONS AND WARNINGS BEFORE PROCEEDING WITH THE INSTALLATION !!!

Appropriate disassembly and assembly methods and procedures are essential to ensure the personal safety of the individual performing the kit installation. Improper installation due to the failure to correctly follow these instructions could cause personal injury or death. Read each step of the installation instructions carefully before starting the installation.

- Always wear safety glasses for eye protection.
- Place ignition switch in the OFF position.
- Always apply the parking brake when working on the vehicle.
- Block the front and rear tire surfaces to prevent unexpected vehicle movement.
- Operate the engine only in well-ventilated areas to avoid exposure to carbon monoxide.
- Do not smoke or use flammable items near or around the fuel system.
- Use chemicals and cleaners only in well-ventilated areas.
- Batteries can produce explosive hydrogen gas, which can cause personal injury. Therefore, do not allow flames, sparks or flammable sources to come near the battery.
- Keep hands and any other objects away from the radiator fan blades.
- Keep yourself and your clothing away from moving parts when the engine is running.
- Do not wear loose clothing or jewelry which can be caught in rotating or moving parts.

DISASSEMBLY INSTRUCTIONS:

The following section will guide you through the disassembly of the stock components. Special care should be taken to label fasteners and parts that are taken off during this procedure since many will be reused.

STEP 1: Cover both fenders with fender covers to protect the vehicle finish.

STEP 2: Disconnect the negative (-) and positive (+) connections to the battery. Cover the positive (+) battery terminal to prevent any contact.

Tech Line (800) 367-3788

Factory Ford shop manuals are available from Helm Publications, 1-800-782-4356

NO PART OF THIS DOCUMENT MAY BE REPRODUCED WITHOUT PRIOR AGREEMENT AND WRITTEN PERMISSION OF FORD RACING PERFORMANCE PARTS.

STEP 3: Disconnect the MAF wiring from the airbox. Loosen the clean air tube clamps and disconnect the clean air tube from the airbox and throttle body (See Fig. 1).

STEP 4: Disconnect PCV tube and remove clean air tube (See Fig. 1).

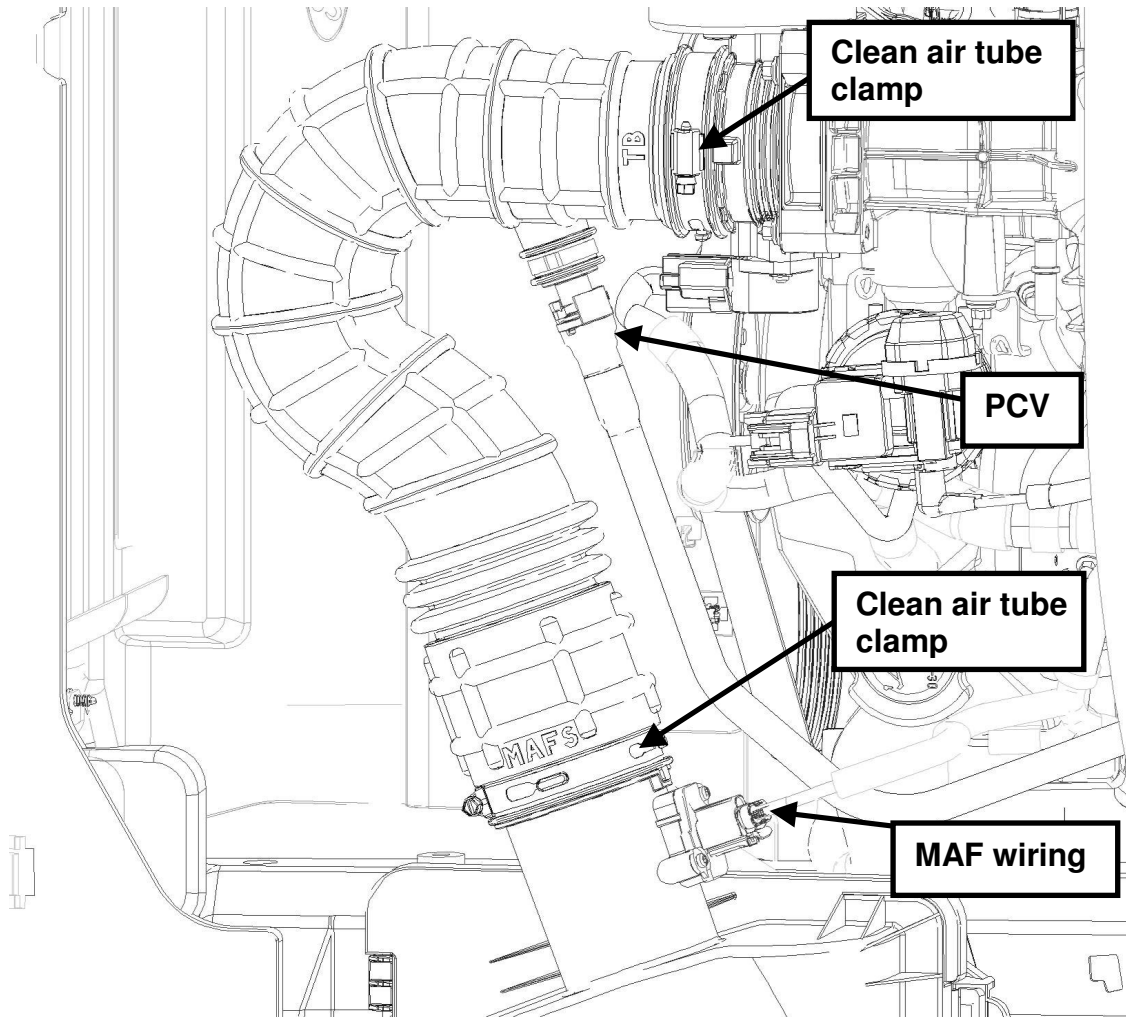

Fig. 1

Tech Line (800) 367-3788

Factory Ford shop manuals are available from Helm Publications, 1-800-782-4356

NO PART OF THIS DOCUMENT MAY BE REPRODUCED WITHOUT PRIOR AGREEMENT AND WRITTEN PERMISSION OF FORD RACING PERFORMANCE PARTS.

STEP 5: Remove the airbox retainer bolt and airbox from vehicle (See Fig. 2).

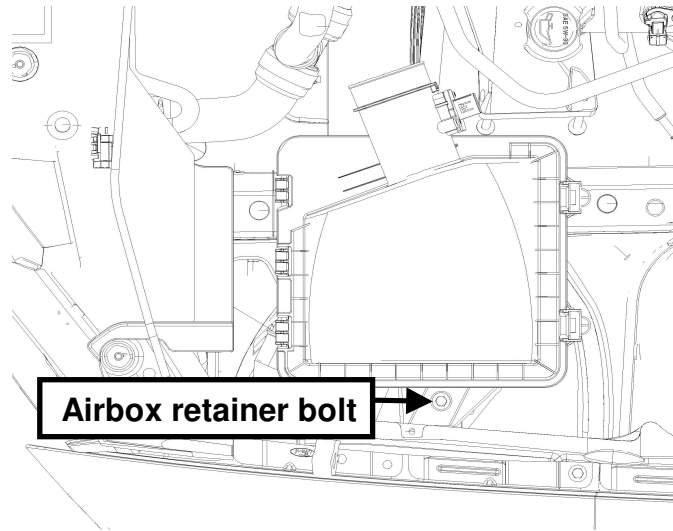

Fig. 2

STEP 6: Remove MAF bolts and MAF from the factory airbox (See Fig. 3).

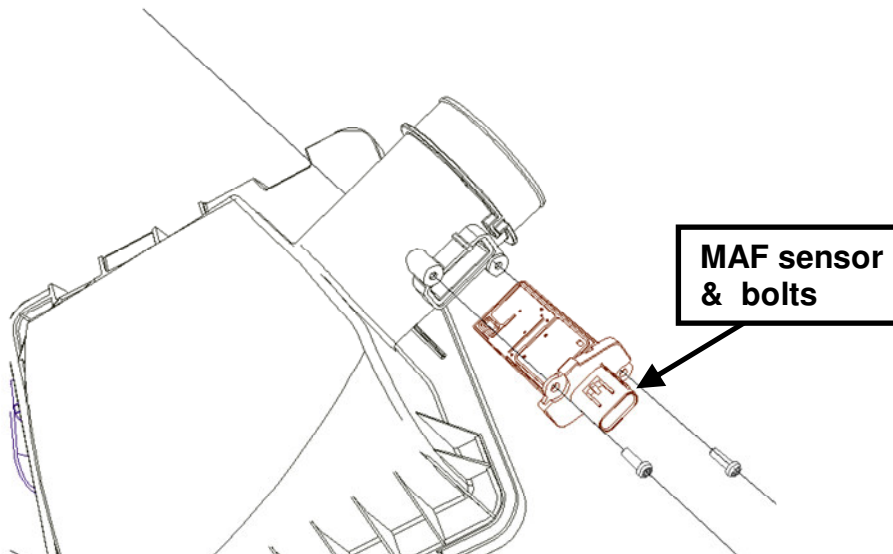

Fig. 3

Tech Line (800) 367-3788

Factory Ford shop manuals are available from Helm Publications, 1-800-782-4356



M-9603-V605 85 mm Cold Air Kit w/Premium Cal. for V6 Mustang INSTALLATION INSTRUCTIONS

NO PART OF THIS DOCUMENT MAY BE REPRODUCED WITHOUT PRIOR AGREEMENT AND WRITTEN PERMISSION OF FORD RACING PERFORMANCE PARTS.

INSTALLATION INSTRUCTIONS:

The following section will guide you through the installation of this kit. If you need to stop during any part of the installation, make sure you cover the clean air tube inlet to prevent foreign material from contaminating your engine.

STEP 1: Install the MAF sensor using the bolts Item #8 into the new air intake bucket assembly. Torque the bolts to 4 Nm (35 lb in) (See Fig. 4).

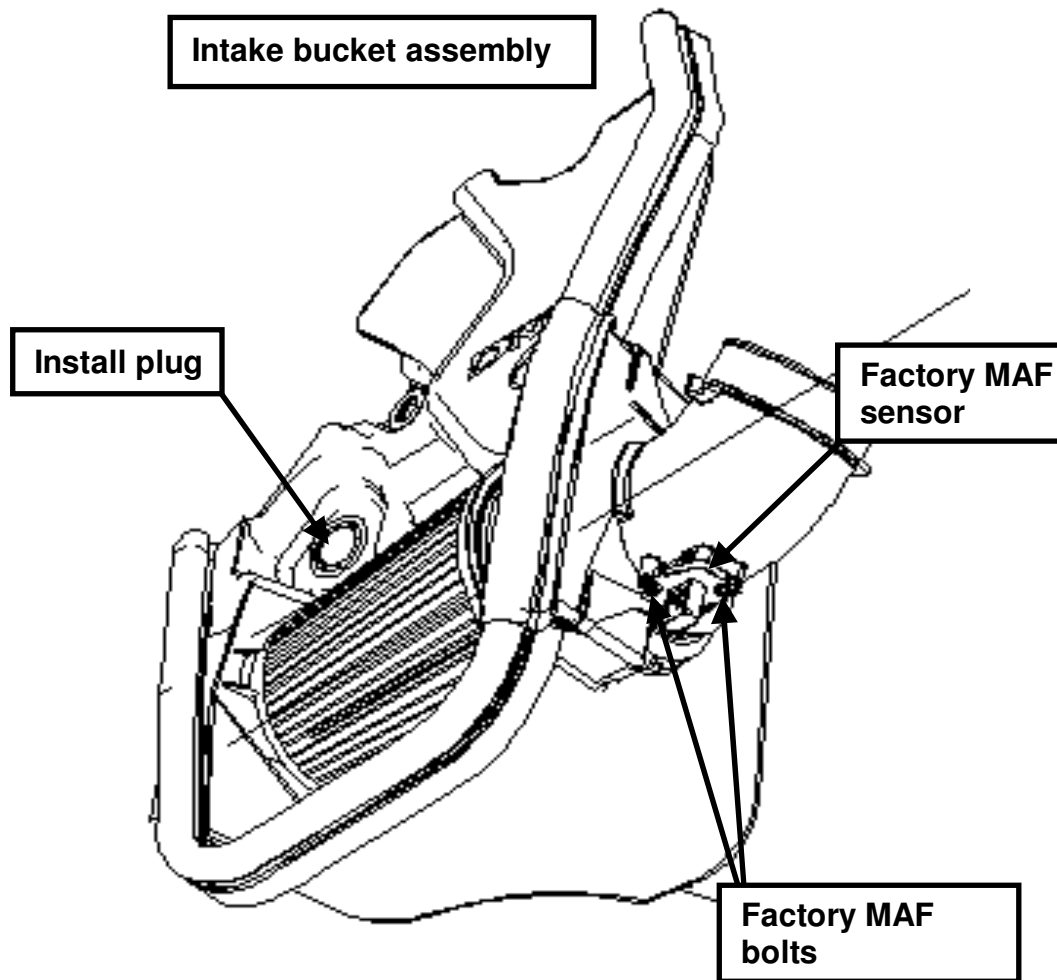

Fig. 4

Tech Line (800) 367-3788

Factory Ford shop manuals are available from Helm Publications, 1-800-782-4356



M-9603-V605
85 mm Cold Air Kit w/Premium Cal. for V6 Mustang
INSTALLATION INSTRUCTIONS

NO PART OF THIS DOCUMENT MAY BE REPRODUCED WITHOUT PRIOR AGREEMENT AND WRITTEN PERMISSION OF FORD RACING PERFORMANCE PARTS.

STEP 2: Locate the ABS module bracket and remove the bolt shown below (Fig. 5). If vehicle is non-ABS, install U-nut in this location.

STEP 3: Install stud in this location and torque to 25 Nm (221 lb in) (See Fig. 5).

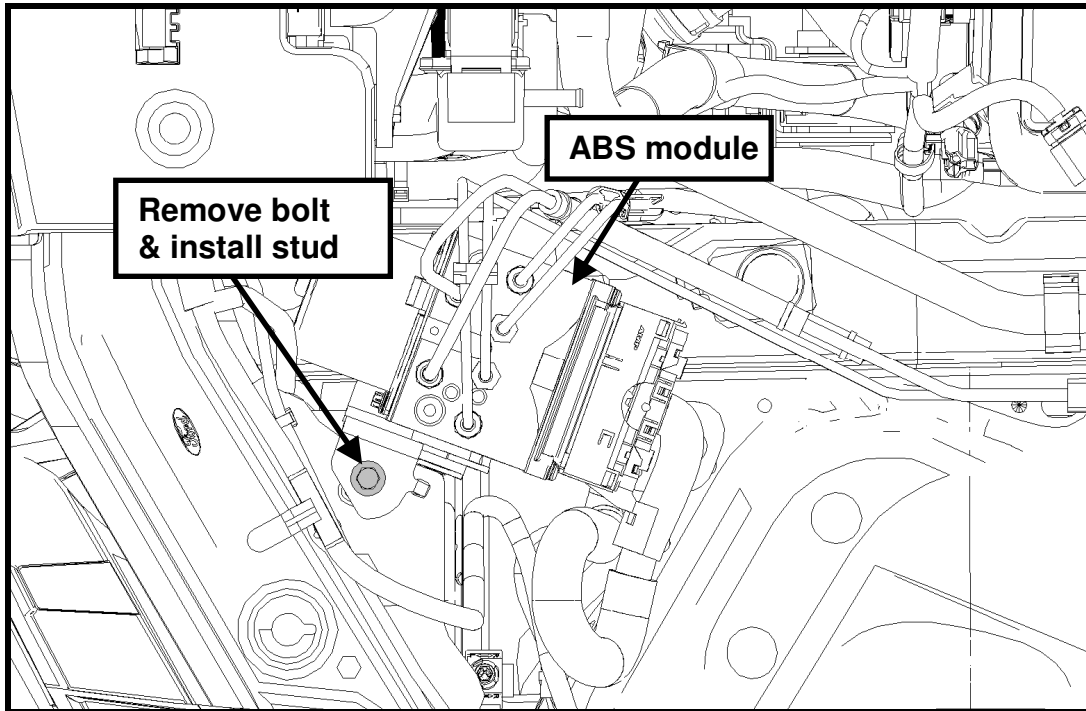

Fig. 5

Tech Line (800) 367-3788

Factory Ford shop manuals are available from Helm Publications, 1-800-782-4356

NO PART OF THIS DOCUMENT MAY BE REPRODUCED WITHOUT PRIOR AGREEMENT AND WRITTEN PERMISSION OF FORD RACING PERFORMANCE PARTS.

STEP 4: Lower the complete airbox assembly into the vehicle using the two pegs as guides into the rubber grommets. Use the take-off airbox bolt and newly supplied nut to secure the airbox in the vehicle. Torque the M6 bolt to 8 Nm (70 lb in), and the nut to 8 Nm (70 lb in) (See Fig. 6).

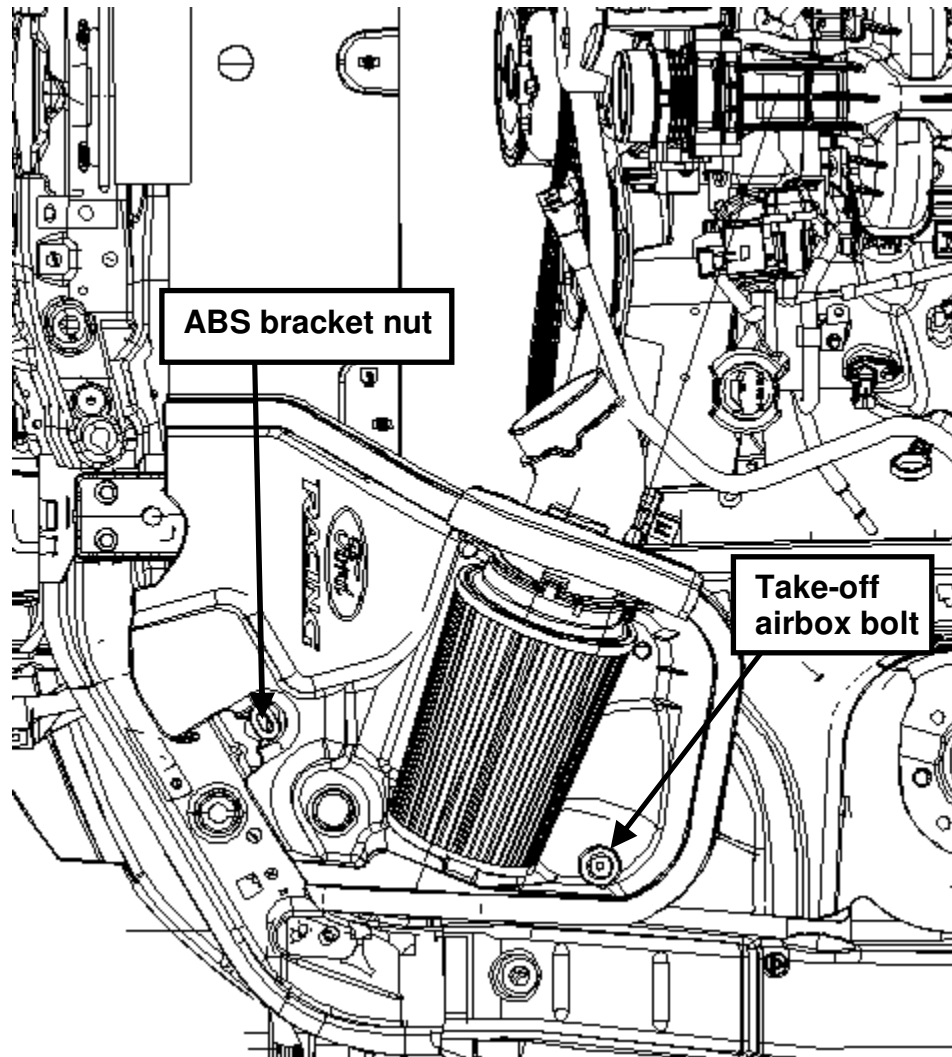

Fig. 6

Tech Line (800) 367-3788

Factory Ford shop manuals are available from Helm Publications, 1-800-782-4356

NO PART OF THIS DOCUMENT MAY BE REPRODUCED WITHOUT PRIOR AGREEMENT AND WRITTEN PERMISSION OF FORD RACING PERFORMANCE PARTS.

STEP 5: Install the new rubber clean air tube onto the throttle body and air intake bucket assembly. Tighten the worm drive clamps and torque to 3 Nm (26 lb in). Re-install the MAF electrical connector onto the MAF sensor and reconnect the PCV hose (See Fig. 7).

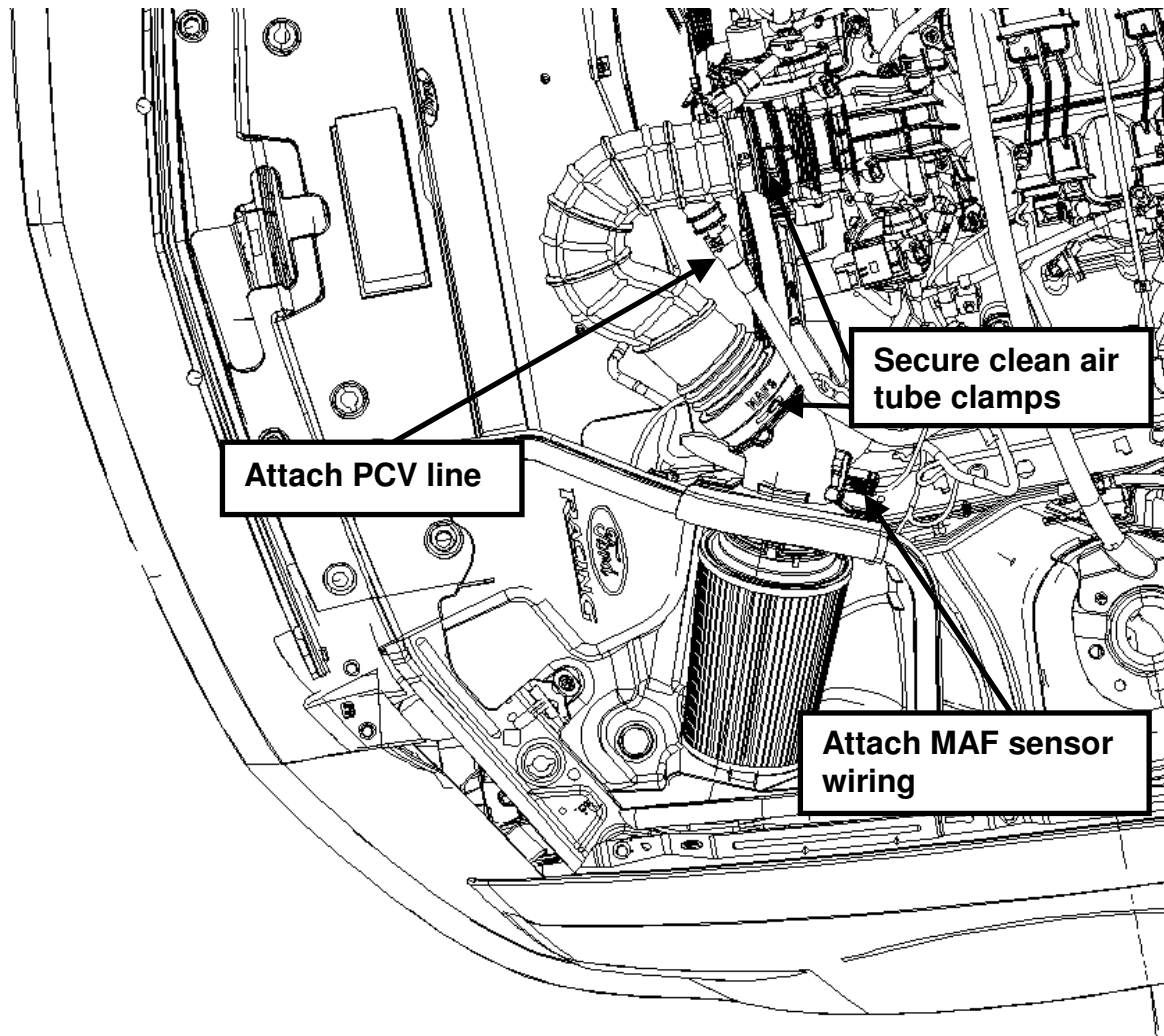

Fig. 7

STEP 6: Re-install the battery connections. Connect the positive cable to the battery first, then the negative cable. Check to insure that the battery is fully charged (12.0V to 14.5V).

Tech Line (800) 367-3788

Factory Ford shop manuals are available from Helm Publications, 1-800-782-4356



M-9603-V605 85 mm Cold Air Kit w/Premium Cal. for V6 Mustang INSTALLATION INSTRUCTIONS

NO PART OF THIS DOCUMENT MAY BE REPRODUCED WITHOUT PRIOR AGREEMENT AND WRITTEN PERMISSION OF FORD RACING PERFORMANCE PARTS.

STEP 7: VERY IMPORTANT!!! THE FOLLOWING STEPS CAN ONLY BE COMPLETED ONCE YOU RECEIVE YOUR FORD RACING PROCAL FLASH TOOL. PLEASE READ THE FOLLOWING INSTRUCTIONS CAREFULLY PRIOR TO INSTALLATION!!!

ProCal Calibration Flash Tool Instructions

Please follow the directions below in order to make sure that your vehicle's powertrain control module (PCM) is successfully programmed (flashed) with the correct engine and transmission calibration. **Do not drive the vehicle until the programming operation has completed successfully.** Please read these instructions in their entirety prior to beginning the flash procedure. If you have any questions or concerns, please call the Ford Racing Tech Line at (800) 367-3788 if they are not addressed in this document.

This ProCal tool has been designed to deliver a performance calibration to your vehicle and keep a copy of your vehicle's stock calibration should you decide to remove the performance pack for any reason. The tool will be locked to your vehicle until the stock calibration has been restored. Once the original calibration has been restored to your vehicle, the performance calibration and corresponding hardware can be installed on another vehicle of the same year, make, model, PCM part number, tire size and axle ratio.

RECALIBRATION PROCEDURE

Before you begin:

Verify that the VIN of the vehicle matches the VIN written on the ProCal tool. If not, call the Ford Racing Tech Line at (800) 367-3788 and do not attempt to flash the vehicle.

STEP 1: Check to see that the battery is fully charged (at least 12.0 volts) and all accessories (radio, interior fan, headlights, etc.) are switched off. It is **strongly recommended** that the vehicle be connected to a battery charger during the flashing process to avoid potential low-voltage issues.

STEP 2: Locate the on-board diagnostic (OBD-II) diagnostic link connector (DLC) located beneath the dashboard on the driver's side of the vehicle. The exact location will vary with the model and year of the vehicle but will always be on the driver's side.

Flashing your PCM:

STEP 1: Ensure the ignition key is in the OFF position.

STEP 2: Hold the ProCal tool so that the side with the instructions on it is facing up and the LEDs and switch are facing you. Slide the function switch to the LEFT (toward center of unit) to select the performance calibration, or to the RIGHT (toward edge of unit) to select the stock calibration.

STEP 3: Connect tool to vehicle diagnostic connector and wait another 5 seconds. A blinking yellow light should appear which means the tool is ready to begin flashing the vehicle's PCM.

Tech Line (800) 367-3788

Factory Ford shop manuals are available from Helm Publications, 1-800-782-4356



M-9603-V605
85 mm Cold Air Kit w/Premium Cal. for V6 Mustang
INSTALLATION INSTRUCTIONS

NO PART OF THIS DOCUMENT MAY BE REPRODUCED WITHOUT PRIOR AGREEMENT AND WRITTEN PERMISSION OF FORD RACING PERFORMANCE PARTS.

- STEP 4:** Turn key to ON position but do not start the engine. The yellow light should stop blinking and stay on during the PCM flashing process, which can take anywhere between 5 minutes and 40 minutes depending on the type of PCM. Please be patient and do not touch the key or turn on any accessories (such as the radio) while flashing is in process.
- STEP 5:** When the tool is finished flashing the PCM, the solid yellow light will turn off and either a solid green or solid red with blinking yellow will result. If the green light is on, turn the ignition key to the OFF position, remove the tool from the DLC and continue to STEP 6. If the red light is on, an error has occurred and the PCM has not successfully been flashed. Refer to the "Light Status" section below for diagnosis.
- STEP 6:** If you flashed the performance calibration into the PCM, attach the enclosed E.O. Label in a clearly visible location under the hood in close proximity to the newly installed performance equipment.
- STEP 7:** Congratulations! You have now successfully flashed the PCM. Start the engine and enjoy.

Light Status:

Solid GREEN only	Flashing process successfully completed.
Flashing YELLOW only	Ready to begin flashing process and waiting for key to be turned to ON position.
Solid YELLOW only	Flashing in process. Please be patient.
Solid RED, blinking YELLOW	Error encountered. Count yellow blink sequence and refer to the following table for error code. If the error code is not shown below, call the Tech Line at (800) 367-3788 for further instructions.

Error Code Diagnosis:

<u># of yellow blinks</u>	<u>Error Description</u>
1	Vehicle mismatch. Attempting to program second vehicle before first vehicle has been returned to the stock calibration.
2	Switch position error. Try again with the switch in the other position.
3	General software upload error. Call Tech Line at (800) 367-3788.
4	General software download error. Try again with battery charger connected.
6	Voltage read error. Try again with battery charger connected.
7	The battery voltage is too low. Try again with battery charger connected.
8	The battery voltage is too high. Check that correct battery is installed in vehicle.
9	The ProCal reprogramming voltage is not working properly. Check the vehicle DLC wiring.

Tech Line (800) 367-3788

Factory Ford shop manuals are available from Helm Publications, 1-800-782-4356



M-9603-V605
85 mm Cold Air Kit w/Premium Cal. for V6 Mustang
INSTALLATION INSTRUCTIONS

NO PART OF THIS DOCUMENT MAY BE REPRODUCED WITHOUT PRIOR AGREEMENT AND WRITTEN PERMISSION OF FORD RACING PERFORMANCE PARTS.

STEP 8: After PCM has been successfully programmed (flashed), check for unusual noises, dash service lights and unusual operation. If problems are detected, immediately stop the engine or vehicle and diagnose and repair the problem.

STEP 9: Affix the E.O. Label on driver side strut tower adjacent to the air filter assembly.

FORD RACING LIMITED WARRANTY

A Limited Warranty is valid only when proof of purchase is registered by the installing Ford dealer by contacting the Ford Racing Tech Line at (800) 367-3788. For warranty details please visit the www.fordracingparts.com website.

Tech Line (800) 367-3788

Factory Ford shop manuals are available from Helm Publications, 1-800-782-4356