



Input Voltage	Controller Max Load	Max Power per 24" Tube	Max Power per Pod
11-14V DC	34W per channel (2 channels per controller)	4.8W	5.4W

Warranty and Disclaimer

Within THREE years after the purchase date, the original buyer may return any XKAlpha controller that has failed due to a defect in materials or workmanship.

Installation of this product must be performed by a licensed professional. Should the failure of the product be the result of damage occurring as a result of improper installation, alteration of the product or an act or omission on the part of the consumer, this warranty is void. XKGLOW Lighting shall not be responsible for any consequential damages which arise from the use and/or installation of the product. If the kit is installed in any manner other than specified, XKGLOW Lighting reserves the right to deny any warranty claims at the discretion of the technical support department. Any product return must include the original packaging, invoice number and a statement of the alleged defect. Upon receipt of the returned product, the company will test the product for defect. If the results of the testing do not support the warranty claim, do not reveal any defect or indicate consumer negligence in the installation and handling of the product, then the product will be returned to you and you will be charged a reshipping fee. If the product is returned from an address within the continental United States, within the first 30 days after purchase, and is found to be defective, XKGLOW Lighting will exchange or refund the original purchase expense. This offer does not extend to the cost for shipping charges on any international packages.

Additional Disclaimer Terms

Please check your local and state laws for the proper use of this product.

- Improper installation of electrical products such as lighting may cause damage to any vehicle or device to which the improperly handled or installed lighting is attached.
- Improperly installed product may cause electrical injury to persons.
- It is recommended that the kit should be installed by a licensed professional.
- XKGLOW assumes no liability for the installation of the product.
- Warranty or liability will not exceed the product purchase price, which shall be buyer's sole and exclusive remedy.

Return/Exchange Procedure

1. Email [xk@xkglow.com] to notify us of the product issue as well as the item number and name of customer on invoice.
2. We will send you the trouble-shooting guide to fix the issue, or to narrow down which of the component(s) need to be replaced. If the issue still exists, we will ask you to send back the defective items to be replaced.
3. Please send the returned item as instructed, along with claims and a telephone number where you can be reached.
4. After the returned item(s) have been accepted and inspected, we will issue a refund or replace the items ASAP. For refunds, item(s) must be sent to XKGLOW within 30 days from date of purchase. Original shipping charges are not refundable.

We always stand behind our products and are committed to our customers! For questions you may have, please contact xk@xkglow.com. We normally respond within 24 hours. (Monday-Friday).





Mounting Instructions

- 1. Test all components before mounting:** As shown below, plug ALL light units together and connect them to the controller and the switch wiring harness. Connect the RED battery terminal to the POSITIVE pole of 12V DC battery. Connect the BLACK battery terminal to the NEGATIVE pole. Turn on the switch and push the touch button to test all lights. If the lights show any defects, please contact us and we will be happy to replace them for you.

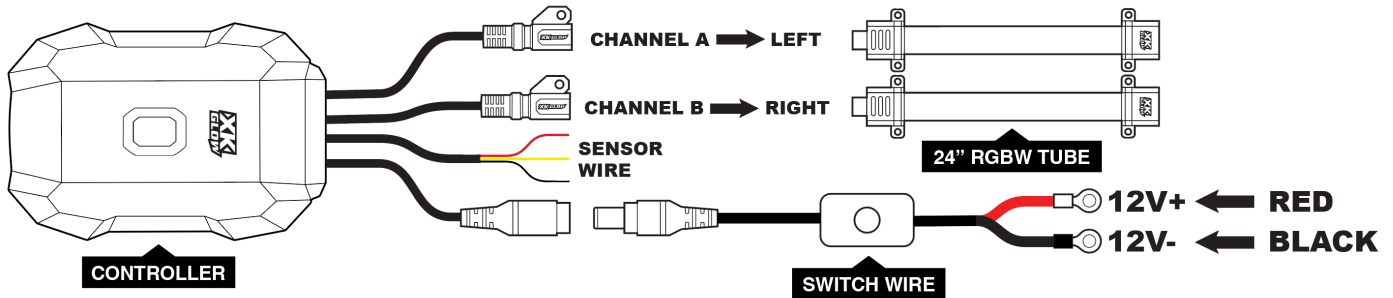

- 2. Plan mounting locations:** Disconnect the tested lights from the vehicle's battery and remove any bodywork that will have the LED lights located behind them. See diagram below for recommended mounting locations. Clean the mounting surface. LOOSELY mount the LED lights using Scotch or painters tape (not included) to the desired locations. (DO NOT firmly attach the lights in this step.) Test chasing light patterns to ensure smooth transitions in the mounted locations. Adjust lights as necessary.

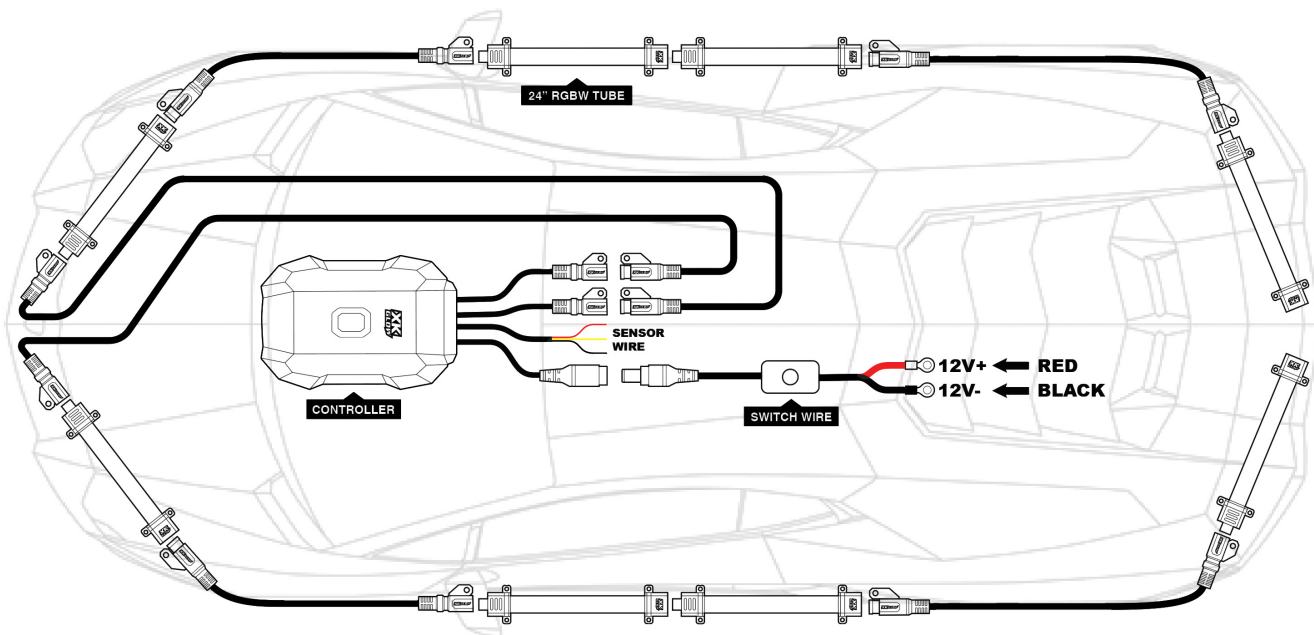

- 3. Mount the lights and wires:** Clean the mounting surface again. Peel off the 3M tape on the back of the light, and attach the lights to the planned locations. Utilize the mounting screw tabs where applicable. These can also be cut off if they are not needed. Zip ties can also be used for additional support mounting the lights. Connect all extension wires and the switch wiring harness. **WARNING-** Do not force the plugs together! If they don't snap together, verify that all the pins line up. If a pin is out of place, it must be straightened up for the plug to snap together.

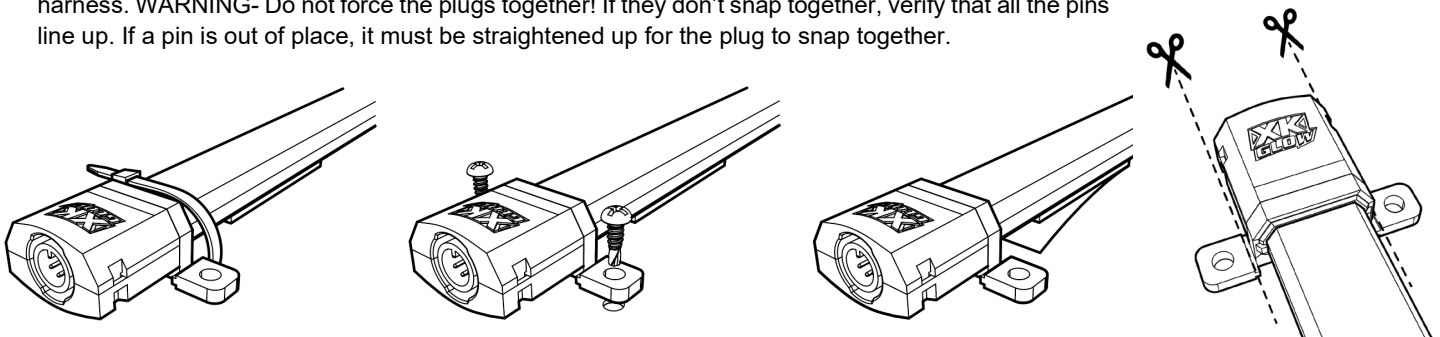

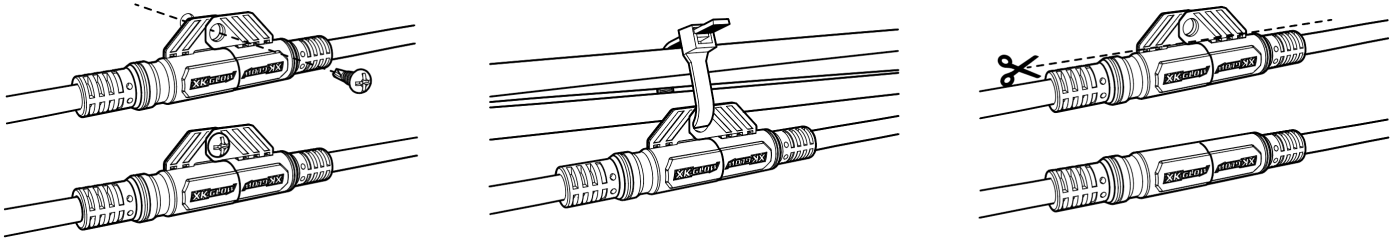

- Secure all wires and connectors:** Use provided screws or zip ties to neatly mount and hide any loose wires. The tabs can also be cut off to help the wire fit through tight spaces. Make sure they are not touching anything hot or located on moving parts. Install the ON/OFF switch in a dry and convenient location. Use provided end caps to cover all uncovered connectors.
- Tap sensor wires:** If utilizing the sensor wire functions, the typical setup would be tapping them into the 12V brake and two turn signals. However, they can also be tapped to other sources such as door courtesy light. The triggered action in the Sensor Wire section of the app is fully customizable, so the wire colors are not designated for each function. Remember what color wire is attached to which function, as you will select the sensor wire color in the app to assign a light sequence.
- Connect to 12V DC power:** Firmly connect the wire terminals to the positive and negative poles of the battery. Power on, download the **XKAlpha** App, and enjoy!

Configure Zones

After the XKAlpha controller is powered up, all lights will come on white. Once it is connected to the device, the first thing we recommend doing is setting the light zones. The easiest way to do this is initiating the Auto Assign feature, but you can also manually configure up to 10 zones. Click the Configuration tab (1) and then go to the Light Zone Map page (2). In the Light Zone Map, you are able to create up to 10 zones. Do this by selecting each light or sets of lights into their own zone. Press the Auto Assign (3) button to have the controller automatically split the lights into 2 zones by how they are connected to the controller. Don't forget to click Save (4)!

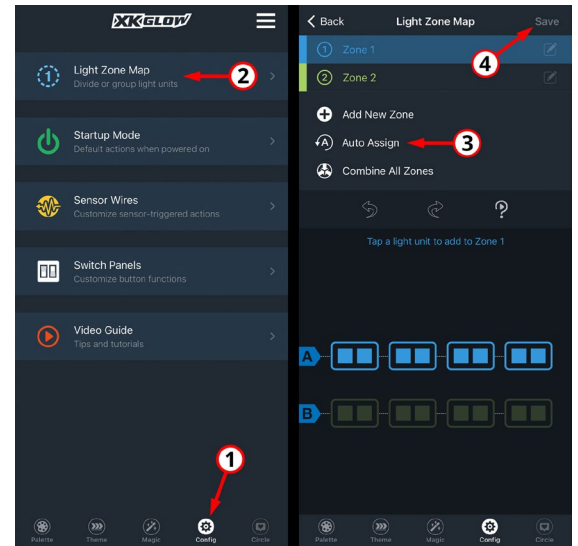

Creating Startup Mode

Create a Startup Mode to set a default for the lights every time they power on. Open the Configuration tab (1) and go to the Startup Mode page (2). There are multiple themes that you can set the Startup to, or you can create a new mode (3). If you want to make the lights a solid color, choose the *Solid Morph* pattern (4). Then delete the colors until a single color is customized (5). That is how you would default the lights single color when powered on. Don't forget to click Save (6)!

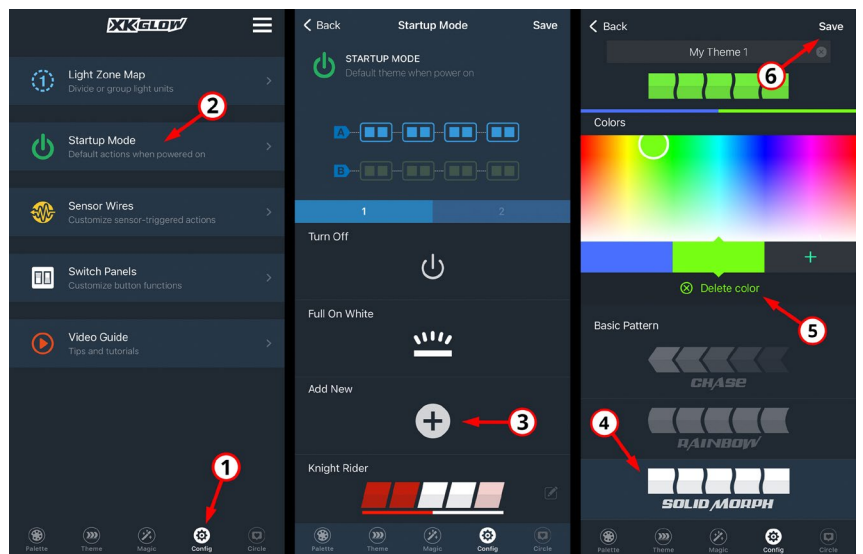



Configure Sensor Wires

If you tap one or more sensor wires to the vehicle, you will configure them in the Sensor Wire section. After the zones have been assigned, open the Configuration tab (1) and go to the Sensor Wires page (2). Then select which wire color you are working on (3). For example, if you are doing turn signals, select Zone 1 or 2 depending on what side of vehicle you are connecting to and choose the turn signal pattern (4). Be sure to set the other Zone to No Change so only one side of the vehicle functions as a turn signal (5). Don't forget to click Save (6)! Suggested signal source for tapping sensors: brake, turn signal, reverse, door, high beam.

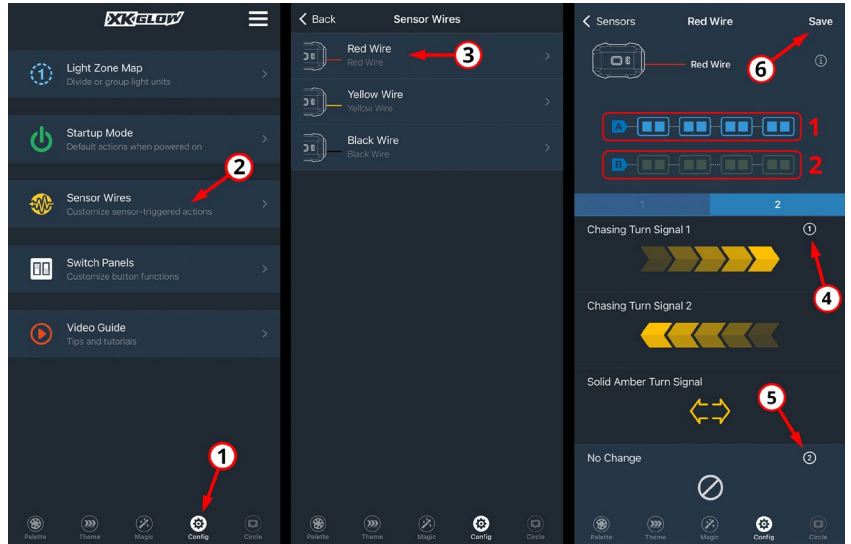

Customize Themes

You can customize an existing theme or create one from scratch! Open the Theme tab (1) and, to create a theme from scratch, press Add New (2). To edit an existing theme, press the pen icon next to the theme (3). In the theme editor there are multiple patterns to choose from. You can even change the direction of chasing patterns (4). You also have the ability to change the colors in a theme and add or take away the amount of color in the pattern. Once you have customized or edited the theme, don't forget to click Save (6)!

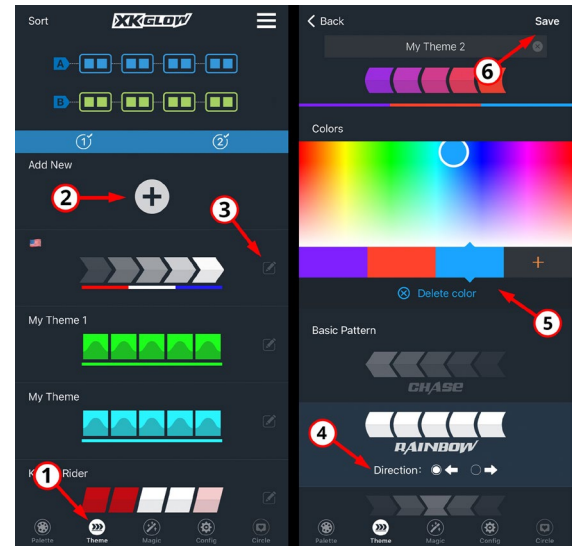

Please note: There are multiple XKGLow apps on the App Store. Only the XKAlpha App will work with the XKAlpha Bluetooth Controller. The App icon is pictured here.