



QUARTER STICK

316 0006, 316 0009, 316 0014

PISTOL GRIP

316 2006, 316 2009, 316 2014

INSTALLATION INSTRUCTIONS

READ ALL OF THIS INFORMATION CAREFULLY

- All adjustments must be made with shifter and transmission in Neutral(N).
- Adjustments are critical and must be precise.
- Do not mix components (all parts including cable must be Hurst components provided with kit).
- If a shifter is removed and reinstalled, adjustments must be checked and re-adjusted.
- Always check cable for freedom of motion before connecting at shifter and transmission arm.
- Routing of cable should avoid sharp bends (permanent damage of cable will result).
- **Important:** Ensure that cable has adequate clearance around headers and exhaust system. Excessive heat will melt the cable liner and result in cable breakage.

Failure to comply with any of the above may result in malfunction of shifter operation. Damage to cable due to sharp bending, kinking, or excessive heat is not covered by warranty.

NOTE: RETAIN THESE INSTRUCTIONS FOR FUTURE REFERENCE.

IDENTIFICATION AND CONTENTS OF KIT

DESCRIPTION	PART NO.
1. Shifter Assembly	
2. Cable	500 0025
3. Cotter Pin (3/32" x 3/4")	190 0001
4. Cable Attachment Clip	127 5702 (2)
5. Cable Support Clamp	126 0013 (2)
6. 1/4" X 1" Self-Tapping Hex Head Sheet Metal Screw	272 5699 (4)
7. 1/4" Flatwasher	267 3478 (4)
8. Cable Pivot	194 0005
9. Cotter Pin (1/16" x 1")	97093086
10. Wire Terminal	252 7600 (2)
GM Turbo-Hydramatic Installations—GM 350, 400 & 200 Metric	
11. Bracket—Trans.—Cable Mounting	117 4778
12. 5/16-18 x 3/4 Socket Head Cap Screw	215 0018
13. Arm—Transmission Control Shaft	105 0080
Chrysler Installations—Torqueflite 904 & 727	
14. Bracket—Trans.—Cable Mounting	117 0094
15. Arm—Transmission Control Shaft	105 0082
16. 5/16" Flatwasher	96000559 (4)
Ford Installations—C4 & C6	
17. Bracket—Trans.—Cable Mounting—C4	117 0037
18. Bracket—Trans.—Cable Mounting—C6	117 0038
19. Arm—Transmission Control Shaft	105 0087
Chrysler and Ford Installations	
20. 1/4-28 x 1-1/2 Hex Head Cap Screw	215 4052
21. 1/4" Split Lockwasher	97090082
22. 1/4-28 Square Nut	179 0056

Bagged Hardware Packages—PT. 154 0175 (GM) & PT. 154 0179 (Ford/Chrysler)

These instructions detail the installation of the Hurst Quarter Stick Shifter for a GM Turbo TH350/400 with forward pattern valve body, Ford C-4/C-6, and Chrysler A-904/A-727 transmission for both forward and reverse valve body applications. Please refer to the specific instructions on your particular application for detailed information.

The shifter can be mounted directly to the floor with the four sheet metal screws supplied (item 6, contents of kits).

You may also purchase the optional Hurst **Quick Release Aluminum Mounting Plate #195 0225**, which adds a professional look and allows easy removal. For a finished look, Hurst also offers an attractive **Aluminum Cover Kit #130 0041** as well as a **Plastic Cover #130 0055**.

TECHNICAL SERVICE

The Hurst Technical Service Department is staffed by highly trained individuals who can answer technical questions, provide additional product information and offer various recommendations. Please direct Technical Service calls, correspondence and warranty questions to the following address:

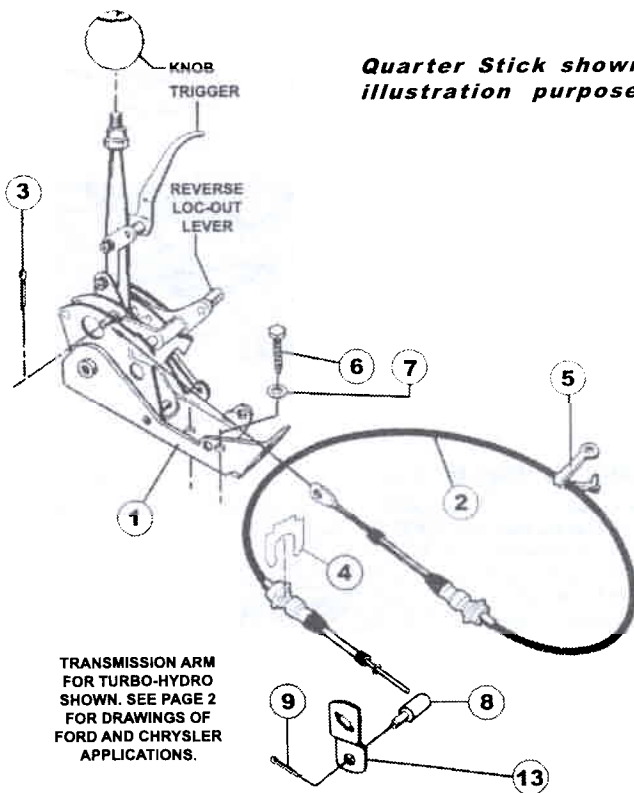

Quarter Stick shown for illustration purposes.

CABLE CONNECTIONS AT TRANSMISSION CONTROL SHAFT

CHRYSLER 904 & 727 TORQUEFLITE

NOTE:
CABLE APPROACHES
TRANSMISSION FROM
FRONT OF VEHICLE

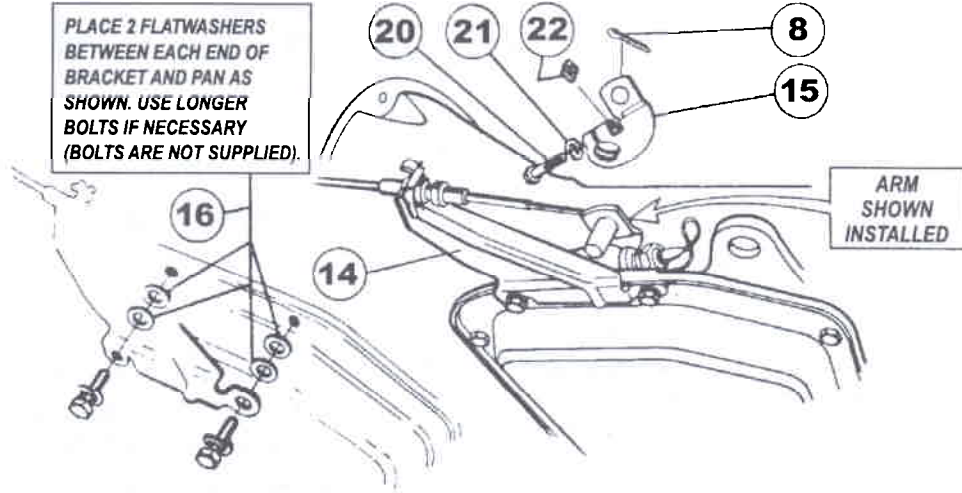

GM INSTALLATIONS

All GM installations use this bracket
(PT. 117 4778). Refer to drawings
below for method of fastening.



400 TURBO-HYDRAMATIC

Use stock bolts to fasten end holes of
bracket to transmission.

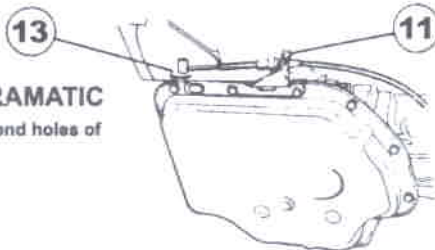

350 TURBO-HYDRAMATIC

Install bracket with 5/16-18 x 3/4" socket
head cap screw (#11) located at rear of
center slot in bracket (bracket forward
as far as possible). Use stock pan bolt
in front slotted hole of bracket.

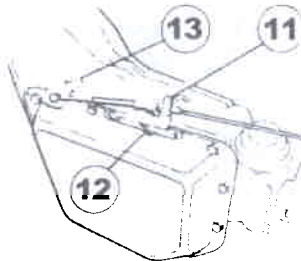

200 TURBO-HYDRAMATIC

Install bracket with
5/16-18 x 3/4" socket head cap
screw (#11) located in the
middle of the center slot in
bracket. Use stock pan bolt in
front slotted hole of bracket.
Adjust in either direction for
proper neutral alignment.

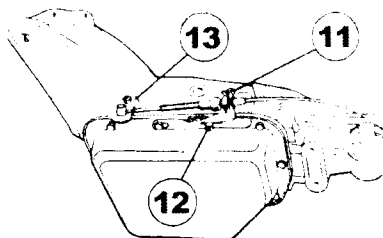

FORD INSTALLATIONS

MODIFICATION OF STOCK FORD ARM AND INSTALLATION OF HURST ARM

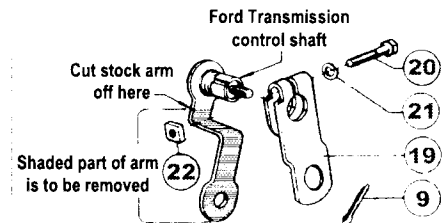
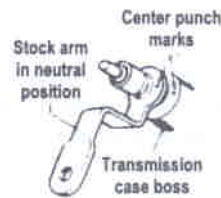

Cut shaded part of stock arm off. Install Hurst arm on shaft
loosely using the supplied hardware. Do not tighten at this
time. Follow the adjustment procedure outlined in the body
of the instruction sheet.

FORD C-4

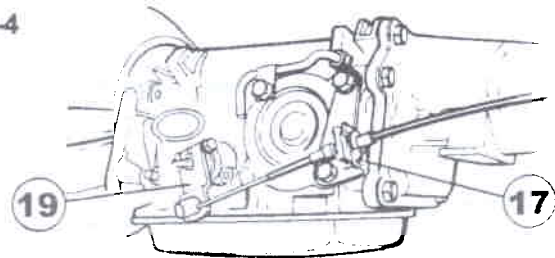

FORD C-6

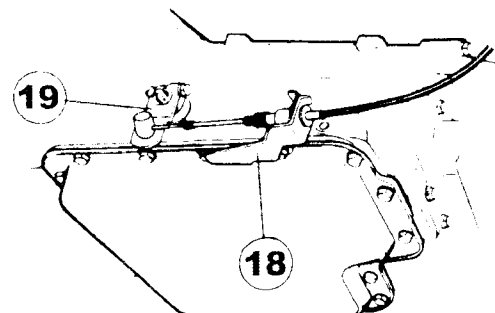

With shifter mounted in the desired location, direct eyelet end of shifter cable through shifter frame. Secure shifter cable to frame using cable clip (#4), push clip down until it is firmly seated. Put shifter in neutral and slide cable eyelet over pin on shifter stick (see exploded view), install cotter pin (#3) through hole in shifter pin to hold cable in place.

Remove stock transmission arm. Refer to the illustration for your transmission and install the proper Hurst transmission arm per the directions. Install the corresponding cable bracket per the illustration. Carefully route the shifter cable towards the cable bracket (avoid any sharp bends as cable can become permanently damaged). Insert cable eyelet through slot in mounting bracket and secure using cable clip (#4), push clip down until it is firmly seated.

Thread cable pivot (#8) onto threaded end of cable. Make sure that the transmission is in neutral. Thread cable pivot in or out on the cable until it lines up directly with the hole in the transmission arm. Lock cable pivot in this position with the 10/32 nut supplied on the shifter cable. Insert cable pivot into hole in transmission arm. Carefully shift through each gear (up and down) and check for free entry of cable pivot into transmission arm at each gear position. Re-adjust if necessary to insure proper engagement in each gear. When satisfied with adjustment, secure cable pivot to transmission using supplied cotter pin (#9).

Route cable in transmission tunnel so as to avoid binding or kinking of the cable. Make sure that the cable is not too close to or in contact with the exhaust system. When you are satisfied with the routing, secure the cable to the chassis using the supplied cable clamps (#5). Drill a 1/4" hole in the tunnel or frame, fold clamp around cable and push the split end through the 1/4" hole. Push the pointed end into the split end until it snaps tight.

ALIGNMENT PROCEDURE

1. Position shifter stick at "N" (Neutral).
2. Position transmission arm at "N" (Neutral).
3. Adjust cable as directed in text which appears on this page.
4. Fasten cable end on pin with cotter pin.

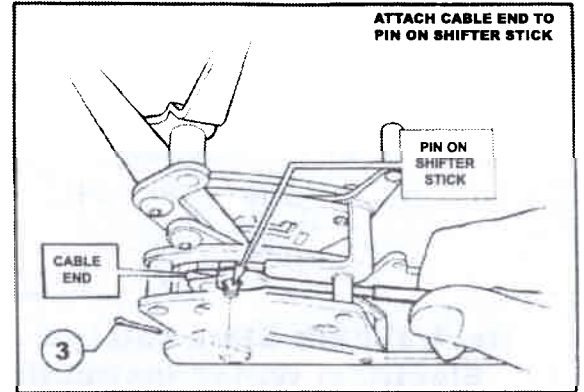
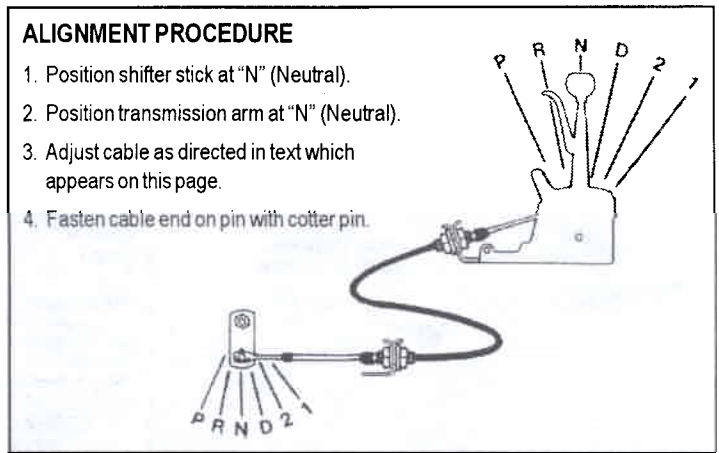

SHIFTING PATTERN – FORWARD VALVE BODY

Lockplate opening shown

1 FIRST GEAR



PULL STICK ALL THE WAY BACK

FRONT OF VEHICLE

2 SECOND GEAR



PUSH STICK FORWARD

FRONT OF VEHICLE

3 THIRD GEAR



PULL TRIGGER AND HOLD

4



WHILE HOLDING TRIGGER, PUSH STICK FORWARD

FRONT OF VEHICLE

5



RELEASE TRIGGER AND RELAX STICK

FRONT OF VEHICLE

6 NEUTRAL



PUSH STICK FORWARD TO NEUTRAL

7 REVERSE

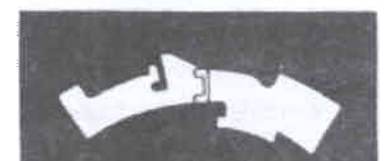

PUSH REVERSE LOC/OUT LEVER DOWN AND PUSH STICK FORWARD

8 PARK PULL TRIGGER



PULL TRIGGER AND HOLD

9

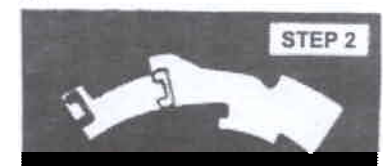

PUSH STICK FORWARD ALL THE WAY AND RELEASE TRIGGER

SHIFTING PATTERN - REVERSE VALVE BODY

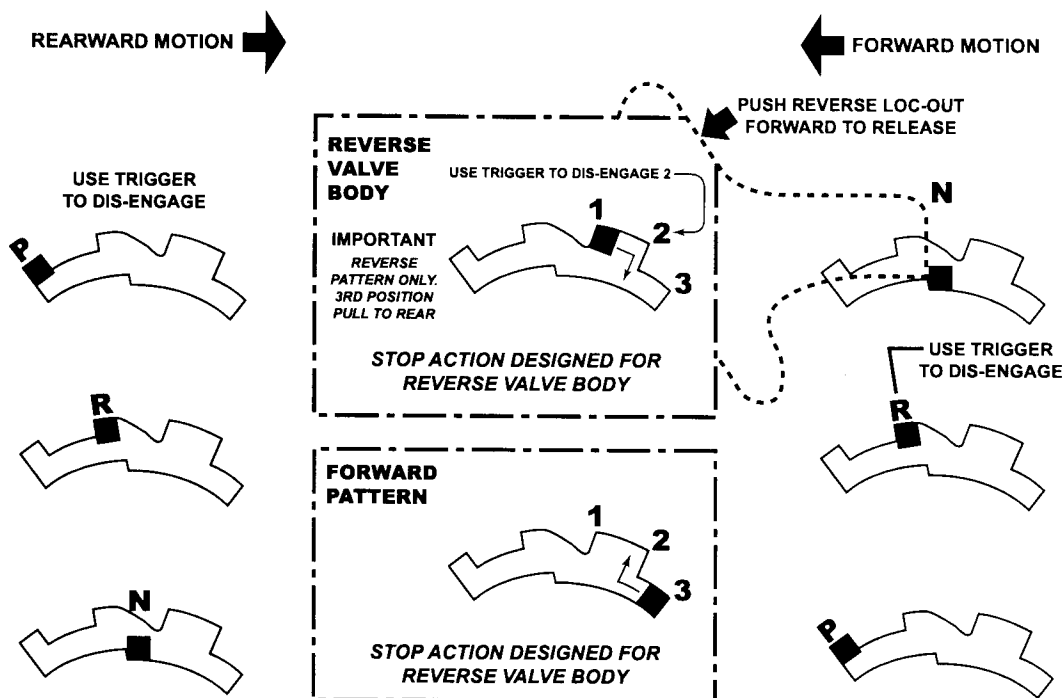

Neutral/Park Start Safety Switch Electrical Wiring Instructions

1. Vehicle must have engine off, parking brake securely engaged, wheels blocked, with transmission and shifter in the neutral position before attempting switch wiring hookup.
2. Install the supplied female crimp terminals to two suitable lengths of wire, use at least 16 gauge wire for this installation.
3. Plug each female connector onto the spade terminals of the micro switch located in the plastic switch housing.
4. Using the wiring diagram below as a guideline, install the switch wires into your starting circuit.
5. With shifter and transmission in neutral, check to see that engine starts. Repeat this with the shifter and transmission in the park position. If necessary, loosen the screw on the adjusting collar located near the shifter handle and adjust slide mechanism back and forth until vehicle starts in neutral and park only.

Pistol Grip Roll/Control Switch

The Pistol Grip Quarter Stick shifters come equipped with a precision, snap-action, 12 volt switch that is ideal for operating the Hurst Roll/Control, nitrous oxide systems, trans. brakes, etc. It is a normally open, momentary contact, quick release switch with a maximum 10 amp. rating.

NEUTRAL/PARK SWITCH WIRING DIAGRAM (GENERAL)

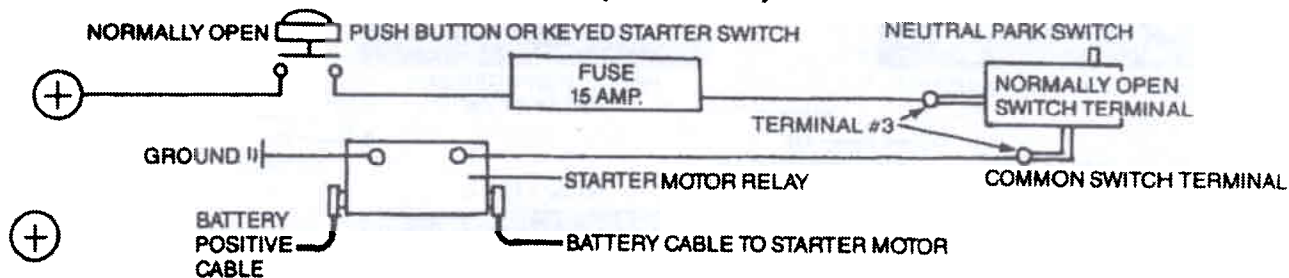

HURST IS A MR. GASKET PERFORMANCE GROUP COMPANY

FORM # 159 2306